



S!M PATI®

Installation and Operating Instructions

SIMPATI® Software 4.70

Imprint
Installation and operating instructions for SIMPATI® software 4.70
Original instructions
Language: English
Document ID: en 2020.09 63837141

Alle in der Betriebsanleitung genannten Schutzmarken und Handelsmarken sind Eigentum der jeweiligen Hersteller/Besitzer. Hersteller/Besitzer.

Table of Contents

CHAPTER 1	INTRODUCTION AND GENERAL INFORMATION	9
1.1	Finding your way around	9
1.1.1	Signs	9
1.1.2	Symbols	9
1.2	Warranty	10
1.3	Licence rights	10
1.4	Intended use	10
1.5	Safety instructions	10
1.6	Prerequisites	11
1.7	Service hotline	12
CHAPTER 2	INSTALLATION	13
2.1	Installing SIMPATI®	14
2.2	Uninstalling SIMPATI®	23
2.3	Firewall setup	24
CHAPTER 3	CONFIGURING SIMPATI® AND THE CHAMBER (SIMSETUP)	27
3.1	System configuration and registration	30
3.2	Configuring chambers with a Mincon / Simcon controller	31
3.3	Chambers with data logger	34
3.4	Configuring chambers with a Simpac controller	35
3.5	Configuring chambers with a MOPS / CTC / TC controller	36
3.6	Configuring chambers with a DMR controller	38
3.7	Configuring chambers with an ISAR controller	39
3.8	Manually editing the configuration data	40
3.8.1	Initialising the password	40
3.9	Other controllers, third-party devices and their special features	40
3.9.1	MOPS / CTC / TC controller	40
3.9.2	Gateway with CTC controller	40
3.9.3	ISAR controller	41
3.9.4	Mincon / Simcon controller	41
3.9.5	DMR controller	41
3.9.6	Prodicon controller	41
3.9.7	Dicon 50x/100x controller and Imago 500	42
3.9.8	Rotronic Hygroflex 3	42
3.9.9	Testa FID2000MP	42
3.9.10	Stange SE-4xx and 5xx	42
3.9.11	Prodicon Plus controller	43

	3.9.12	2/3 channel process interface	43
	3.9.13	QNX controller	43
	3.9.14	Anaprog controller	43
	3.9.15	SBC controller	43
	3.9.16	Eurotherm 900 EPC	44
	3.9.17	Data logger 8590-9C, 8990-6C and 8390-1, 8990-1	44
CHAPTER 4		STARTING SIMPATI®	45
	4.1	Starting SIMPATI®	45
	4.2	SIMPATI® in offline mode	48
CHAPTER 5		SIMPATI® MAIN SCREEN	49
	5.1	SIMPATI® main screen make-up	49
	5.1.1	SIMPATI®'s main screen	50
	5.1.2	Main screen's context menu	52
	5.1.3	Context menu for test systems	53
	5.1.4	Test system icons and shortcuts	55
	5.2	SIMPATI® user logon/logoff	58
	5.3	Tabular view of main screen	59
	5.4	User administration	61
	5.4.1	Start screen of user administration	62
	5.4.2	Creating users	63
	5.4.3	Editing general user data	64
	5.4.4	Changing the password settings	65
	5.4.5	Editing the system access rights	66
	5.4.6	Editing the chamber access rights	67
	5.4.7	Creating user groups	68
	5.4.8	Editing general group data	68
	5.4.9	Set a group's passwords, system and chamber access rights	69
	5.4.10	Edit menu	70
	5.5	SIMPATI® setting	71
	5.5.1	SIMPATI® settings - configuration	72
	5.5.2	SIMPATI® settings - view	74
	5.6	Shutting down SIMPATI®	75
CHAPTER 6		CHAMBER CONFIGURATION	77
	6.1	General chamber configuration	78
	6.2	Test system-to-SIMPATI® interface configuration	80
	6.3	Setting profiles/limits	81
	6.4	Showing errors/warnings	82
	6.5	Showing chamber details	83
CHAPTER 7		MANUAL MODE AND CHAMBER STATUS	85

7.1	Tests in manual mode	86
7.2	Chamber status screen	88
CHAPTER 8	CREATING A TEST PROGRAM	93
8.1	General notes on creating programs	93
8.1.1	Guaranteed holding time	93
8.2	Using the symbol editor to create test programs	94
8.2.1	Analog function for control variables and control values	96
8.2.2	Functions affecting the program sequence	96
8.2.3	Configuring a profile	97
8.2.4	Test	98
8.2.5	Working with program blocks	100
8.2.6	The »File« menu function	106
8.2.7	»Edit« menu function	107
8.2.8	»View« menu function	110
8.2.9	»Extras« menu function	110
8.2.10	»Program« menu function	111
8.3	Using the graphic editor to create test programs	112
8.3.1	»File« menu item	113
8.3.2	»Edit« menu function	115
8.3.3	»View« menu function	115
8.3.4	»Options« menu function	117
8.4	Using the tabular editor to create test programs	127
8.4.1	Test program table	128
8.4.2	The "View" menu function	131
8.4.3	The "Edit" menu function	131
8.4.4	"File" menu function	136
8.5	Creating test programs for a shock test chamber	138
8.5.1	Creating test programs for shock chambers with a DMR controller	138
8.5.2	Creating test programs for shock chambers with a CTC controller	141
8.5.3	The »File« menu function	144
8.5.4	Creating test programs for shock chambers with a Simcon and Simpac controller	144
CHAPTER 9	TEST PROGRAM TRANSFER BETWEEN THE CHAMBER AND SIMPATI®	151
9.1	Loading test programs from SIMPATI® to the chamber controller	151
9.2	Loading test programs from the chamber controller and saving them in SIMPATI®	152
CHAPTER 10	STARTING / STOPPING A TEST PROGRAM	153
CHAPTER 11	ARCHIVING	155
CHAPTER 12	GRAPHIC ANALYSIS	157
12.1	Graphic analysis screen – panels	157

12.2	Graphic analysis screen – header menu	159
12.3	Graphic analysis screen – side menu	160
12.4	Legend	161
12.5	Panorama view of test process	162
12.6	Zoom function	163
12.6.1	Zoom controls	163
12.6.2	Zooming a view	164
12.6.3	Moving the zoom section	167
12.7	Measurements menu	168
12.8	Time range menu	171
12.9	Show images menu	173
12.10	Info menu	175
12.11	View menu	176
12.12	Control variables axis menu	178
12.13	Digital channels axis menu	180
12.14	Export data menu	181
12.15	Help menu	182
12.16	Error message	183
CHAPTER 13	CHAMBER REPORTS AND MESSAGES (SIMREPORT)	185
CHAPTER 14	AUTOMATIC GENERATION OF E-MAIL MESSAGES IN SIMPATI®	187
14.1	Prerequisites	187
14.2	Setting up messages	188
14.2.1	Setting up profiles	189
14.2.2	Setting up recipients	190
14.3	General settings	191
14.4	Starting/stopping SimMailer	192
14.4.1	Autostart when launching SIMPATI®	192
CHAPTER 15	FAULTS, WARNING/ALARM/ERROR MESSAGES	193
15.1	Showing the list of warning/alarm/error messages	193
APPENDIX	CHAMBER CONTROLLER SETUP	195
APPENDIX	MODEL 8990-6C DATA LOGGER SUPPORT	199
APPENDIX	PATCH CABLE PIN ASSIGNMENT	201
APPENDIX	»SIMDOWNLOAD.EXE«	207

APPENDIX	HTTP SERVER	209
APPENDIX	SIMPATI[®] TCP/IP PORT (SIMSERV)	213
	0.1 Define general chamber settings.....	229
	0.2 Email	229
	0.3 Installation for operation in the pharmaceutical sector	229
APPENDIX	ETHERNET INTERFACE	231
APPENDIX	OPERATION OF TS130 MODEL SHOCK CHAMBERS WITH SIMCON/32 CONTROLLER.	239
APPENDIX	INSTALLATION FOR OPERATION IN PHARMACEUTICAL ENVIRONMENTS ..	243
APPENDIX	EXAMPLES	245
APPENDIX	GLOSSARY AND TIPS	261

1 INTRODUCTION AND GENERAL INFORMATION

Prior to installation:



- ▶ Take heed of the instructions in this manual, the chamber manual and the manual of the associated controller.
 - ▶ As the operator, issue appropriate operating guidelines on the basis of this operating manual. Take the relevant local and plant-internal conditions and the language of the operating personnel into account in doing so.
-

1.1 Finding your way around

1.1.1 Signs

Explanation of the signs used in this operating manual:

- Items in a list are indicated by a dash.
- ▶ Instructions for the user and operator are indicated by a triangle.
- Cross references are indicated by an arrow.

1.1.2 Symbols

Signal words and symbols are used throughout this manual in the following way:



DANGER

Failure to comply with the directions results in death or severe injury.



CAUTION

Failure to comply with the directions may result in minor injury.

ATTENTION

Failure to comply with the directions results in property damage.



This is used to indicate additional helpful information.

Warranty

1.2 Warranty

Warranty claims will be considered only if the Warranty Claim Card is filled in and returned immediately and if the specified requirements are met. The warranty is limited to the replacement of the software package, all other claims are herewith excluded.

1.3 Licence rights

The application is supplied with a single-user licence.

Acquire further licences if you wish to operate several chambers.

Contact our Service Centre for additional licences.

1.4 Intended use

This software package supports the control of up to 99 chambers equipped with different types of controllers.

1.5 Safety instructions



DANGER

Disregarding the operating manual

Failure to comply with the instructions in the operating manual for the chamber and its controller may result in death or serious injury.

- ▶ Follow the instructions.
-

1.6 Prerequisites

Computer system	IBM-compatible PC (Intel i5, 2.2 GHz or equivalent)
Operating memory	≥ 8 GB
Available hard drive capacity for SIMPATI®	1 GB
Supported interfaces	RS 232, RS422, RS 485, IEEE 488.2 with external converter, Ethernet TCP/IP
Printer	All printers supported by the operating system
Operating system (64-bit)	Windows 10 Windows 8 or Windows 8.1 Windows 2012 Server Windows 2016 Server
Port enables (firewall) required	→ 2.3 »Firewall setup« (page 24)
Software	.NET Framework 3.5 and 4.72 Internet information service (IIS) 7.5 or higher for the SIMPATI® Web application. The default IIS server configuration is assumed. If further security settings are configured on the server, then the web application may need to be configured correspondingly.

Table 1-1 System requirements



NOTICE

Malfunctions due to impermissible accessories

- ▶ To minimise fault liability use the connection cables supplied exclusively.
- ▶ Take into account that special applications may have different requirements. Follow the specifications for these applications in the Appendix.

Service hotline

1.7 Service hotline

Telephone number if service is required: +49 180 5666556

Documentation in *.pdf format

The operating manual can be read using any standard PDF reader. The operating manual is included on the enclosed CD.

2 INSTALLATION

S!MPATI® is the central tool for controlling up to 99 test systems. The first step is to install S!MPATI® and to run it to generate a configuration file for every test system.

Installing S!MPATI® is a prerequisite for installing the S!MPATI® add-ons.

S!MPATI®

To obtain the S!MPATI® installation file, either go to the website and download it or contact **weisstechnik®** to send you a CD.

S!MPATI® Add-ons

The following S!MPATI® add-on modules are available:

- S!MPATI® Web
- S!MPATI® TimeLabs
- S!MPATI® Service (S!MPATI® as a Windows service for advanced users)
- S!MPATI® Online (available from summer 2020)

To find instructions for installing and operating the S!MPATI® add-ons, go to:

- www.weiss-technik.com/software.

Installing SIMPATI®

2.1 Installing S!MPATI®

Prerequisites

- A user with administrator privileges to install S!MPATI®.
- Serial number and registration code of your S!MPATI® licence.
- .NET Framework v3.5 and v4.72 (or higher).

To install S!MPATI®

- ▶ Run your Internet browser, type *www.weiss-technik.com/software* into the address line and download the S!MPATI® v4.70 setup file.
- ▶ Run the setup file.
- ▶ Click on “Yes”.
- ▶ Pick a language and click on “OK” to confirm.

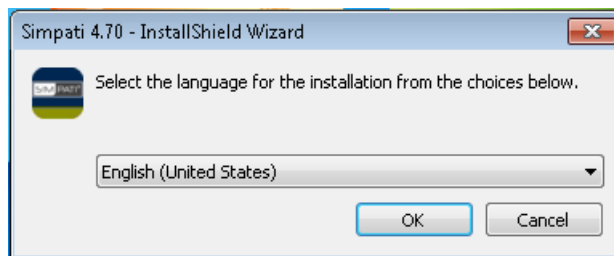

Fig. 2-1: Picking an installation language

- ▶ Read the release notes and click on “Install”.
- ▶ Click on “Next”.



To ensure that the application will run properly, we recommend you to install SIMPATI® on drive C:\.

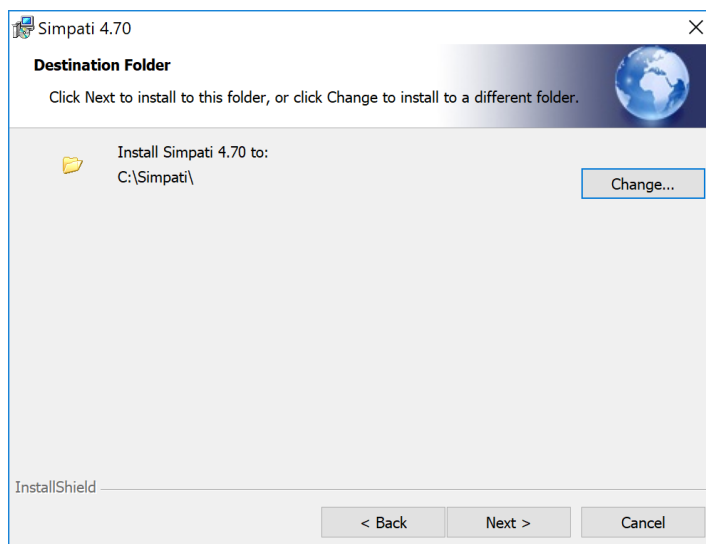

Fig. 2-2: Destination folder

- ▶ Click on “Change” to install SIMPATI® in another destination folder.



SIMPATI® must not be installed in the “Programs” folder because it will not run properly if you do.

- ▶ Set another destination path, then click on “OK” and “Next”.

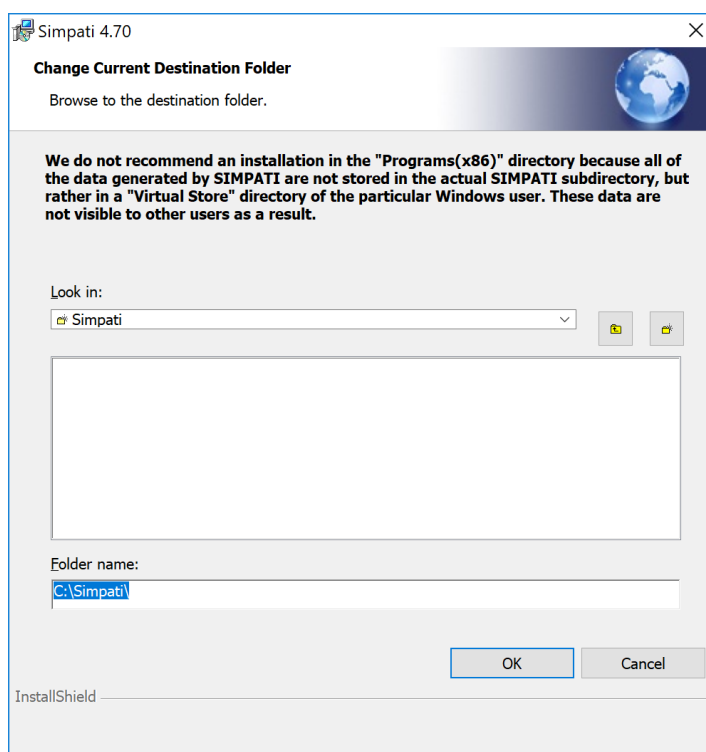

Fig. 2-3: Changing the destination folder

Installing SIMPATI®

- ▶ Click on “Install”.

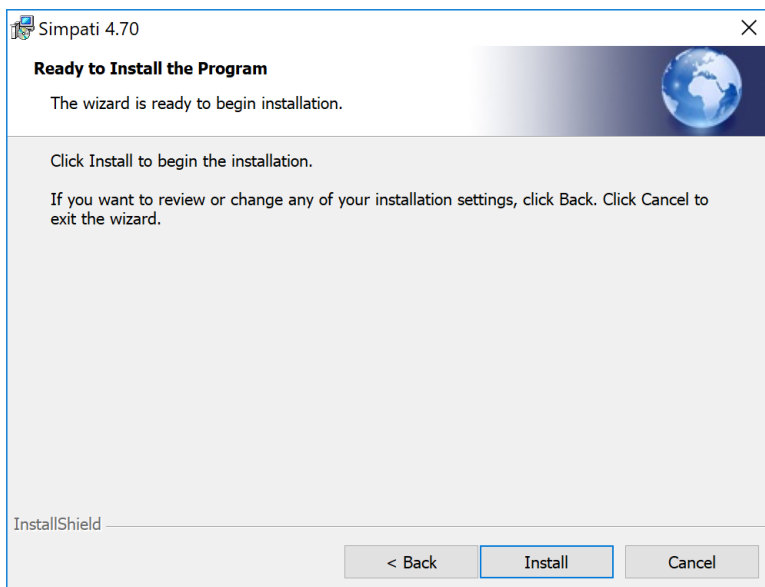

Fig. 2-4: Starting the installation process

- ✓ The licence terms are displayed.

To configure SIMPATI®

- ▶ Read the licence terms and click on “Accept”.
- ▶ Enter the serial number and registration code.

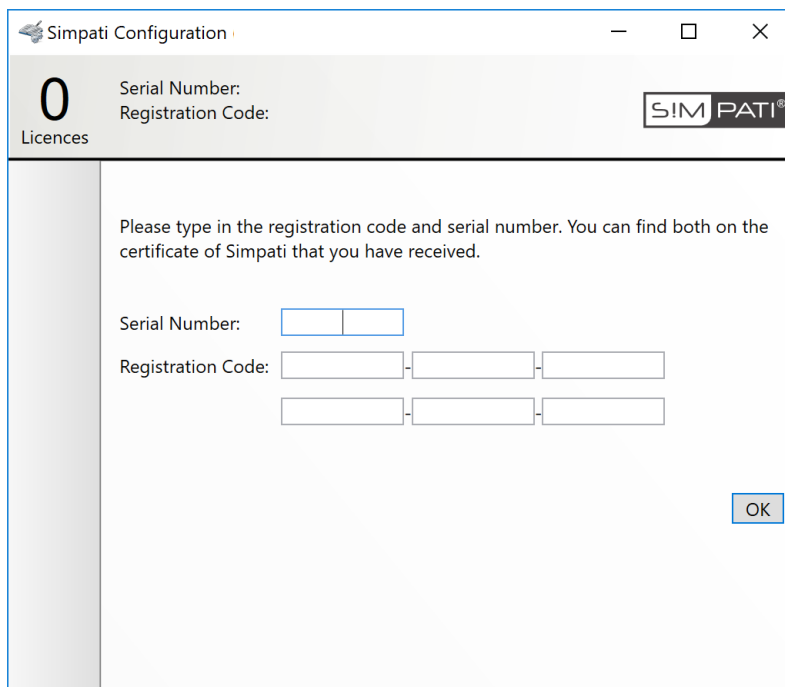

Fig. 2-5: Entering the serial number and registration code

- ▶ Click on “OK”.

- Select the language of the SIMPATI® user interface and set the subdirectories of items 4–7.

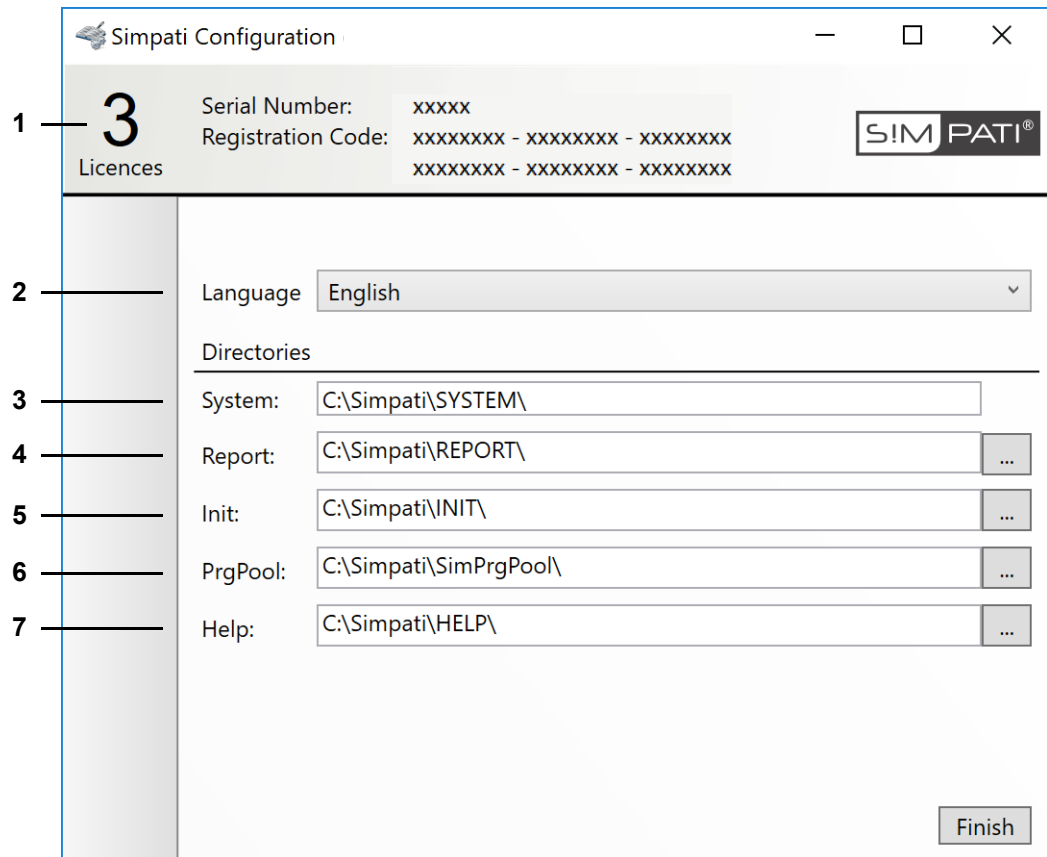

Fig. 2-6: Setting the SIMPATI® installation language and subdirectories

- 1 Number of test systems supported by your licence.
- 2 SIMPATI® user interface language.
- 3 SIMPATI® program directory.
- 4 SIMPATI® report file directory.
- 5 Directory for test system configuration files.
- 6 Test programs directory.
- 7 Help files directory.



We recommend setting the paths of items 4–7 to a directory on a local drive.

Pointing items 4–7 to subdirectories on a network drive may provoke data logging failures and time stamp latencies in response to network problems.

- Click on “Finish” and then on “OK” to confirm.
- ✓ The test system loader launches.

Installing SIMPATI®**To generate test system configuration files**

Before starting SIMPATI®, you must first of all configure at least one test system.

- ▶ Choose the controller of the test system you wish to load into SIMPATI®.

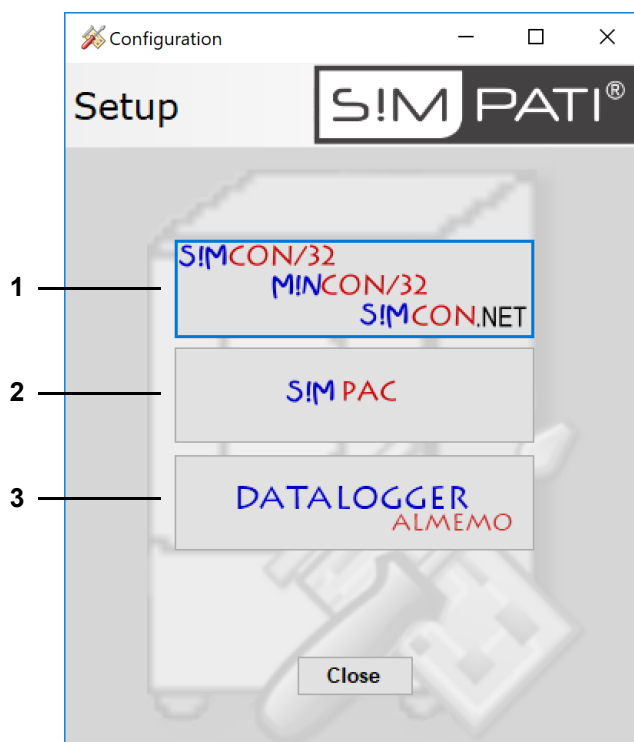

Fig. 2-7: Configuration program

- 1 Click to configure a test system with a Simcon or Mincon controller
- 2 Click to configure a test system with a Simpac controller
- 3 Click to configure a data logger.

Further information:

→ 3 »Configuring SIMPATI® and the chamber (Simsetup)« (page 27)

- ▶ Enter your user name and password and click on “Login”.

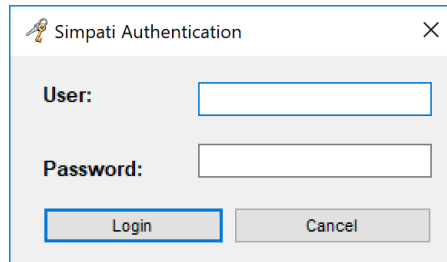

Fig. 2-8: Authentication

When logging in for the first time:

- User name: **Admin**
- Password: **admin**
- ✓ You are asked to change the password.
- ▶ Change your password and click on “OK”.

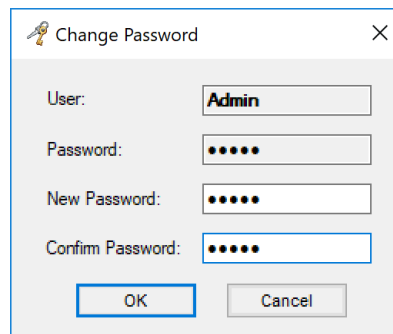

Fig. 2-9: Changing the password:

- ✓ The change of password is confirmed.
- ▶ Click on “OK” and log in using your new password.

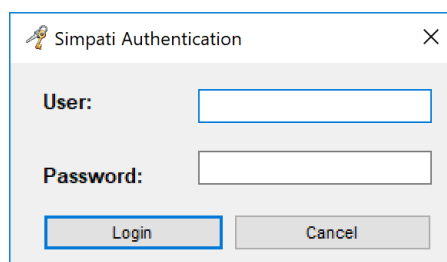

Fig. 2-10: Logging in using the new password

- ✓ A dialog for configuring the link between SIMPATI® and the test system opens.

Installing SIMPATI®

- Set up the link to the preferred test system.

Fig. 2-11: Finding your test system

- 1 SIMPATI® Test system ID.
- 2 Test system IP address.
- 3 Option box for retrieving the test system name.
- 4 Measured data directory.
- 5 Test programs directory.

Further test system configuration details:

→ 3 »Configuring SIMPATI® and the chamber (Simsetup)« (page 27)

- 6 Use the PFI flag to overwrite test systems previously configure in SIMPATI®. We recommend only trusting trained and skilled persons with this kind of manipulation of test system configurations.

- ▶ Enter the IP address of the test system and click on “Search”.
- ✓ If the system finds the test system at the specified IP address, it will generate a configuration file for use by SIMPATI®.

You may launch SIMPATI® when at least one configuration file has been created.

- ▶ Configure SIMPATI® for further test systems, as appropriate.
- ▶ Close the test system setup dialog.
- ✓ The last installer dialog displays.

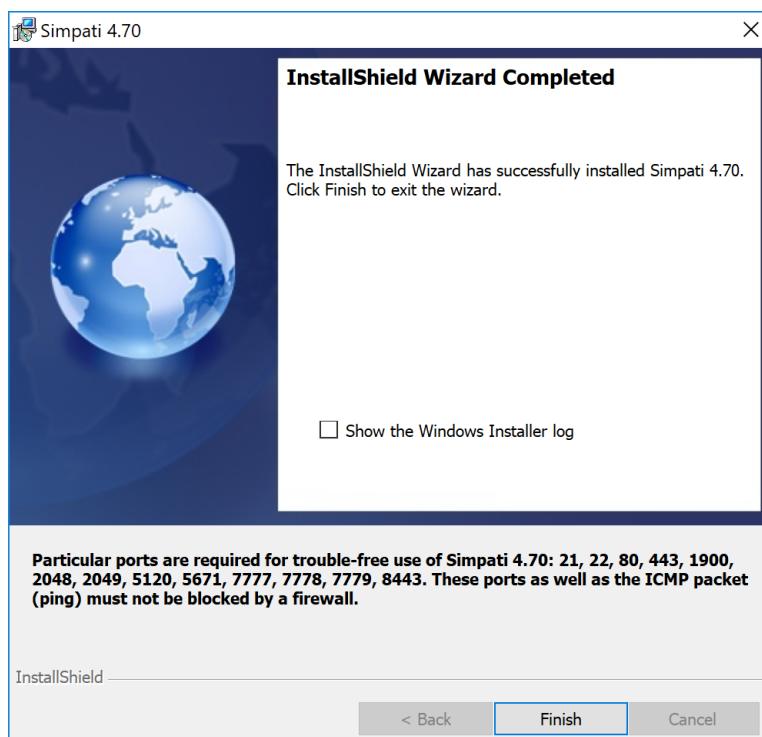

Fig. 2-12: Finalising the installation process

In case problems were encountered during installation, you can display and save a log file by ticking the box next to “Show the Windows Installer log”.

- ▶ Click on “Finish”.

Installing SIMPATI®

- ✓ A log file like the one below will be shown if option “Show the Windows Installer log” is enabled.

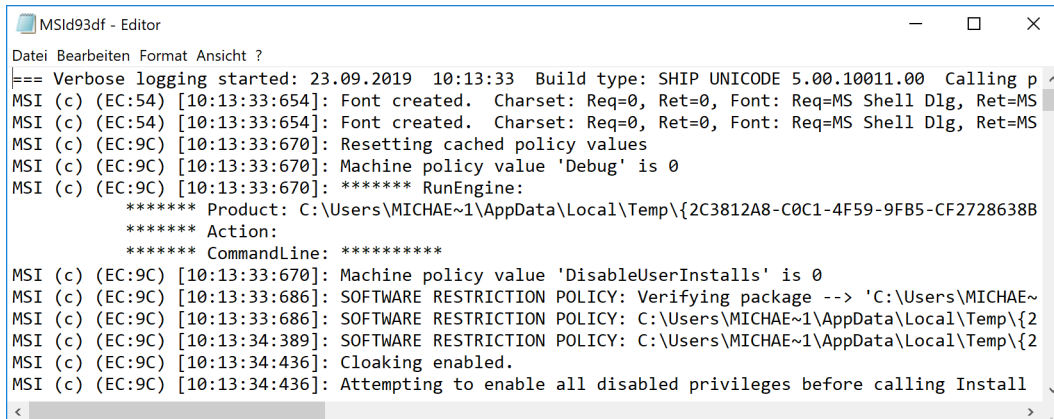

```

MSIId93df - Editor
Datei Bearbeiten Format Ansicht ?
=== Verbose logging started: 23.09.2019 10:13:33 Build type: SHIP UNICODE 5.00.10011.00 Calling p
MSI (c) (EC:54) [10:13:33:654]: Font created. Charset: Req=0, Ret=0, Font: Req=MS Shell Dlg, Ret=MS
MSI (c) (EC:54) [10:13:33:654]: Font created. Charset: Req=0, Ret=0, Font: Req=MS Shell Dlg, Ret=MS
MSI (c) (EC:9C) [10:13:33:670]: Resetting cached policy values
MSI (c) (EC:9C) [10:13:33:670]: Machine policy value 'Debug' is 0
MSI (c) (EC:9C) [10:13:33:670]: ***** RunEngine:
***** Product: C:\Users\MICHAE~1\AppData\Local\Temp\{2C3812A8-C0C1-4F59-9FB5-CF2728638B
***** Action:
***** CommandLine: *****
MSI (c) (EC:9C) [10:13:33:670]: Machine policy value 'DisableUserInstalls' is 0
MSI (c) (EC:9C) [10:13:33:686]: SOFTWARE RESTRICTION POLICY: Verifying package --> 'C:\Users\MICHAE~
MSI (c) (EC:9C) [10:13:33:686]: SOFTWARE RESTRICTION POLICY: C:\Users\MICHAE~1\AppData\Local\Temp\{2
MSI (c) (EC:9C) [10:13:34:389]: SOFTWARE RESTRICTION POLICY: C:\Users\MICHAE~1\AppData\Local\Temp\{2
MSI (c) (EC:9C) [10:13:34:436]: Cloaking enabled.
MSI (c) (EC:9C) [10:13:34:436]: Attempting to enable all disabled privileges before calling Install

```

Fig. 2-13: Log file

Send the log file to the Support Team in case you need further assistance.

- ✓ SIMPATI® installation is now complete.
 - ✓ The SIMPATI® icon is available on the Windows desktop.
 - ▶ Contact your system administrator and ask him/her to enable the ports needed to properly run SIMPATI®.
- 2.3 »Firewall setup« (page 24)

2.2 Uninstalling SIMPATI®

Uninstall SIMPATI® if one of the following situations occurs:

<p>Preparing to install a new SIMPATI® release</p>	<p>Before installing a new SIMPATI® release, you must uninstall your previous copy of SIMPATI®</p> <p>When uninstalling SIMPATI®, the configuration of your previous versions and its test data will be retained including the test system configurations, the start-up information, the user privileges, the test programs and your analysis results.</p> <p>After uninstalling your previous version, proceed as follows to install the new one:</p> <p>→ 2.1 »Installing SIMPATI®« (page 14)</p>
<p>Removing SIMPATI® from your PC</p>	<p>After installing SIMPATI®, remember to also remove the SIMPATI® folder and its subfolders.</p> <p>In this case, your test system configurations, start-up information, user privileges, test programs and analysis results will be lost.</p>

SIMPATI® Add-ons

In case you installed SIMPATI® add-ons on top of your regular SIMPATI® installation, you will have to open the Control Panel to uninstall the add-ons in the order below before uninstalling SIMPATI®:

- SIMPATI® Service
- SIMPATI® TimeLabs
- SIMPATI® Web

Prerequisites of uninstalling SIMPATI®

- SIMPATI® has been exited.
- All SIMPATI® processes have been terminated (SIMPATI® processes are the ones beginning with “Sim”).
- All SIMPATI® add-ons have been uninstalled.

To uninstall SIMPATI®:

- ▶ Click on “Control Panel” → “Programs” → “Programs and Functions” or “Programs and Features”.
- ✓ The page displayed lists all programs installed on your machine.
- ▶ Select SIMPATI®, right-click and pick “Uninstall” from the menu.
- ▶ Confirm and wait until the SIMPATI® Installer has removed the application.
- ✓ SIMPATI® has been uninstalled.
- ▶ You can now delete the “Simpati” directory unless you wish to install a new SIMPATI® release.

An alternative method to uninstall SIMPATI® is to go to Windows Start or use the SIMPATI® setup file:



- Click on “Start Button” → “All Programs” → “Simpati” → “Uninstall Simpati”

or

- Run the SIMPATI® setup file → “Next” → “Remove Program” → “Next” → “Remove” → “Finish”.

Firewall setup

2.3 Firewall setup

To ensure that SIMPATI® runs properly, ensure that the following ports have been enabled. Contact your system administrator to verify that these ports are not restricted by a firewall.

Port	Application	Function	Direction	TCP	UDP
21	SIMPATI®	For transferring programs using SimC3K (Simpac or higher).	SIMPATI®->test system	x	-
22	SIMPATI®	For transferring programs using SFTP/SSH (new Simpacs with secure function, SIMPATI® v4.70 or higher).	SIMPATI®->test system	x	-
25	SIMPATI® SimMailer	For standard email dispatch from SIMPATI® (port-dependent from mail server).	SIMPATI®->Mail Server	x	-
80	SIMPATI® TimeLabs	For accessing the webcams.	SIMPATI®->Webcam	x	-
80	SIMPATI® Web	For web access.	Client->SIMPATI® Server	x	-
80	Webseason/SimpacWeb	For web access to Simpac.	Client->test system	x	-
443	Weiss platform agent	Communication with platform for SIMPATI® installations with Internet access.	SIMPATI®->Internet	x	-
443	SIMPATI® TimeLabs	For SSL access to the webcams.	SIMPATI®->Webcam	x	-
443	Webseason/Https	For access to Webseason.	Client->test system	x	-
465 587	SIMPATI® SimMailer	For SSL/TLS email dispatch from SIMPATI® (port-dependent from mail server).	SIMPATI®->Mail Server	x	-
1900	SIMPATI®	For the Device Finder and Maintenance.	SIMPATI®->Network (broadcast)	-	x
2048	SIMPATI®	For the SimC3K driver (to run test systems with Simpac controller).	SIMPATI®->test system	x	-
2049	SIMPATI®	For SIMPATI® setup (Simserv / SIMPATI® Plus) to configure test systems with Simpac controller.	SIMPATI®->test system	x	-
5120	SIMPATI® TimeLabs	For accessing the webcams that are a component part of the controller.	SIMPATI®->test system	x	-
5671	Weiss platform agent	Communication with platform for SIMPATI® installations with Internet access.	SIMPATI®->Internet	x	-
7777	SIMPATI®	JBUS over TCP (for SimConNet test systems, 2006 or earlier).	SIMPATI®->test system	x	-

Table 2-1 Ports to be enabled to run SIMPATI®

Port	Application	Function	Direction	TCP	UDP
7777	SIMPATI®	SimServ under SIMPATI® (for SimServ customer applications).	Client->SIMPATI®	x	-
7778	Customer application	For SimServ customer applications (SimConNet).	Client->test system	x	-
7779	Customer application	For SimServ customer applications (SimConNet).	Client->test system	x	-
8443	Controller	For using the lab computer to update the test systems later.	Client->test system	x	-
8888	SIMPATI®	For encrypted SimServ protocol.	Client->test system	x	-

Table 2-1 Ports to be enabled to run SIMPATI®

Firewall setup

3 CONFIGURING S!MPATI® AND THE CHAMBER (SIMSETUP)

Run the "SimSetup" configuration program to set up the test system and the PC (file storage and other functions).

► Make sure that the following requirements for configuration have been met:

- Check that all connectors are attached to the chamber.
- Check that the chamber has been configured.

→ *Appendix: »Chamber controller setup« (page 195)*

(Chamber address set and interface protocol selected at the chamber.)

Gaps between the chamber numbers:

There should not be gaps between the chamber numbers when assigning them in S!MPATI®!

► Before the chambers are read in, check the settings of the chamber controllers, especially the assignment of the addresses:



→ *Appendix: »Chamber controller setup« (page 195)*

► If you read chambers with Mincon, Simcon, MOPS/CTC/TC or ISAR controllers, a chamber number (address) needs to be assigned twice to assure that there are no gaps between the numbers in S!MPATI®.

This does not result in conflicts because a different interface is used for chambers with a Mincon / Simcon controller than for chambers with a MOPS / CTC / TC or ISAR controller.

-
- You will need the serial number and registration code (included in program package). The registration code is enough if you are just adding a single chamber.
 - The chamber controller type has to be known (→ chamber/control unit operating manual).

Has the correct configuration program (»simsetup« or »simsetup3K.exe«) been selected?

Once SIMPATI® started, the »simsetup3K.exe« program for configuring chambers with Mincon, Simcon or Simpac controllers will run automatically.

An authentication by a Simpati user with system configuration privileges is required in this regard → 4.2 »SIMPATI® in offline mode« (page 48).

The »simsetup.exe« configuration program has been installed for configuration of the remaining controllers. Start the configuration program via the shortcut in the start menu.



You may use either program to configure chamber with a Mincon or Simcon controller.



Enter the serial number and the registration code only via the »simsetup.exe« or »SimConfig.exe« configuration program.

→ 3.1 »System configuration and registration« (page 30)



The Simpac controller (if connected in series) has to be read in via the Simcon / Mincon menu.

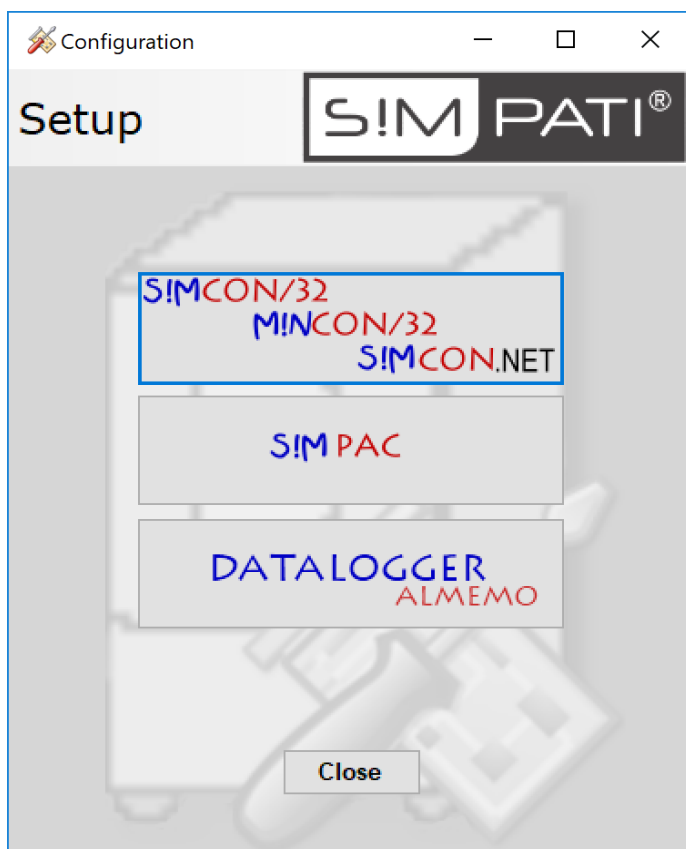

→ 3.2 (page 31)

→ Fig. 3-8: (page 35)

Fig. 3-1: Configuration program »Simsetup3K«

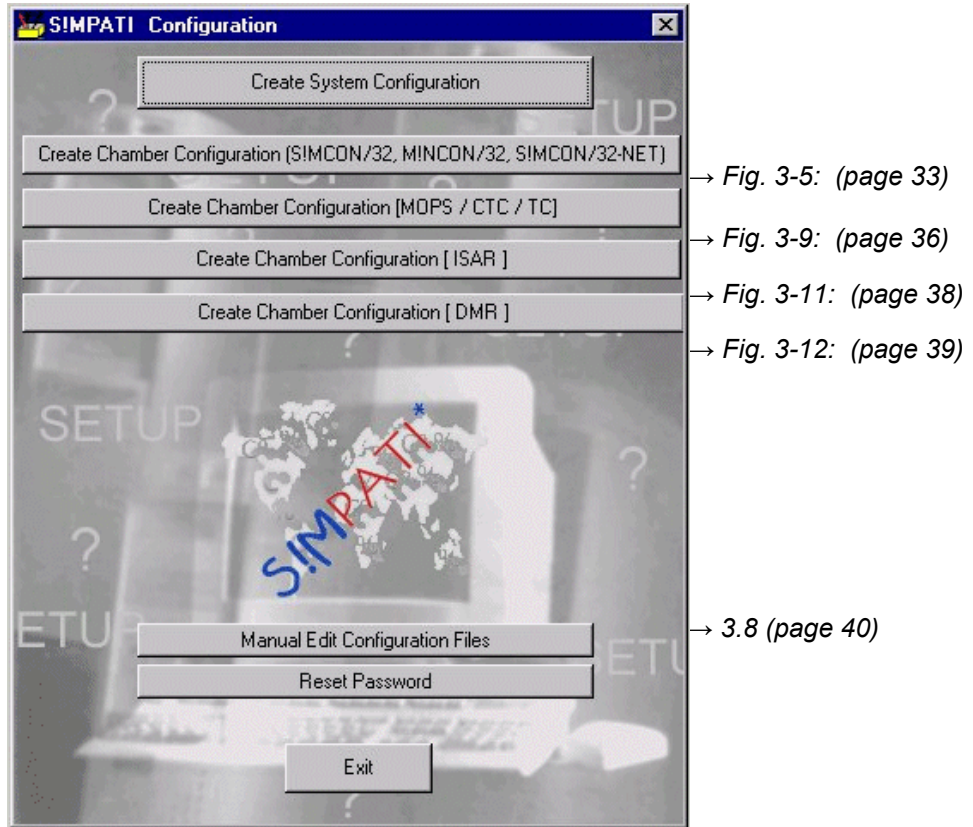

Fig. 3-2: Configuration Simsetup

System configuration and registration

3.1 System configuration and registration

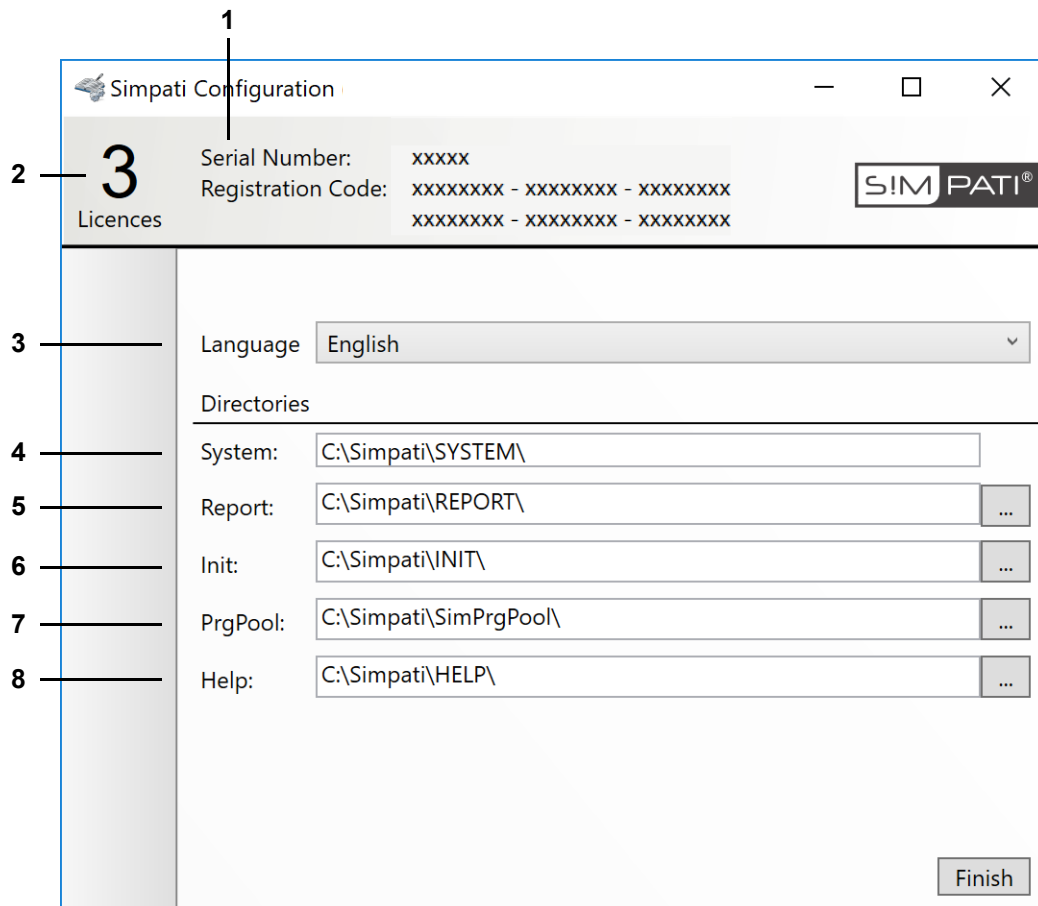

Fig. 3-3: System configuration

- 1 Registration code and serial number.
The registration code is inherited from the installation and can be changed here. When purchasing additional licences enter the new registration code here.
The serial number is inherited from the installation and can be changed here.
- 2 Number of licences available.
- 3 SIMPATI® user interface language.
- 4 SIMPATI® program directory.
- 5 This shows the directory in which the daily reports are saved.
- 6 This shows the directory in which the chamber's configuration files are saved.
- 7 This shows the directory in which the program files created with the tabular editor are saved.
- 8 This directory is intended for the help files but is not used at present.

3.2 Configuring chambers with a Mincon / Simcon controller

Make the settings for the chambers with a Mincon / Simcon controller in the following menus of the corresponding Simsetup (page 28).

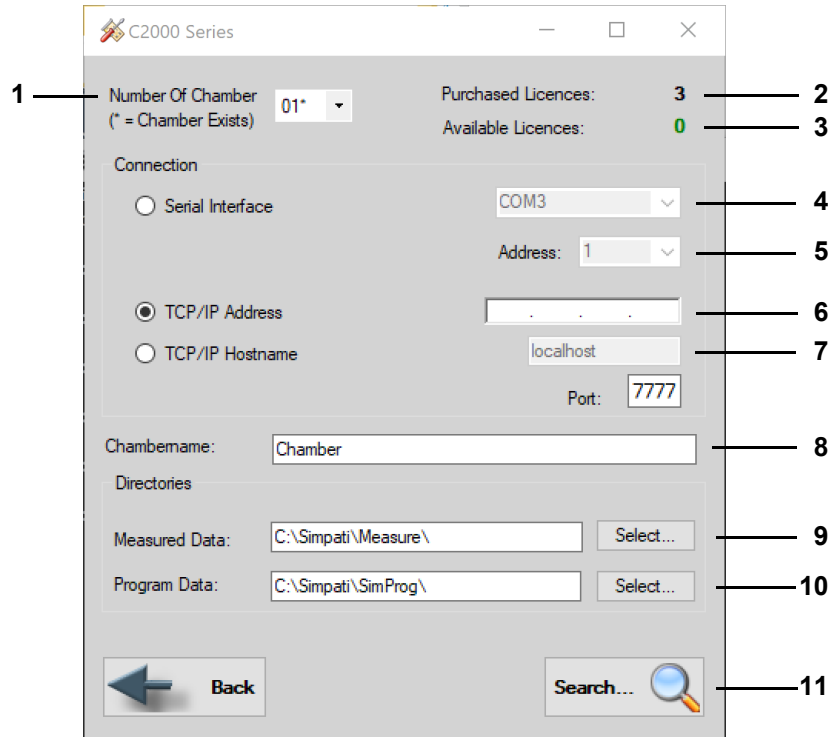

Fig. 3-4: Configuring Mincon / Simcon (»Simsetup3K«)

- 1 Chamber selection.
All previously configured chambers are marked with an asterisk.
- 2 Total number of licenses purchased.
- 3 Licences not yet assigned to a chamber.
- 4 All available ports are shown automatically.

Interfaces:



It may take a while to search for ports.

- Use a different port than for the chambers with other controllers.

5 Address in the chamber controller → *Appendix: »Chamber controller setup« (page 195)*

6 IP address of the chamber.

7 Host name of the chamber.

8 Chamber designation.

Define the name of the chamber here (max. 20 characters). The name appears on the main screen:

→ 5.1.1 »SIMPATI®'s main screen« (page 50).

The name can be changed at a later time:

→ 6.1 »General chamber configuration« (page 78).

9 This shows the directory in which the measured data for this chamber are saved.

Configuring chambers with a Mincon / Simcon controller

10 This shows the directory in which the test programs for this chamber are saved.

11 The system searches via the interface for the chambers connected.

Storing the configuration, see

→ 3.1 »*System configuration and registration*« (page 30)

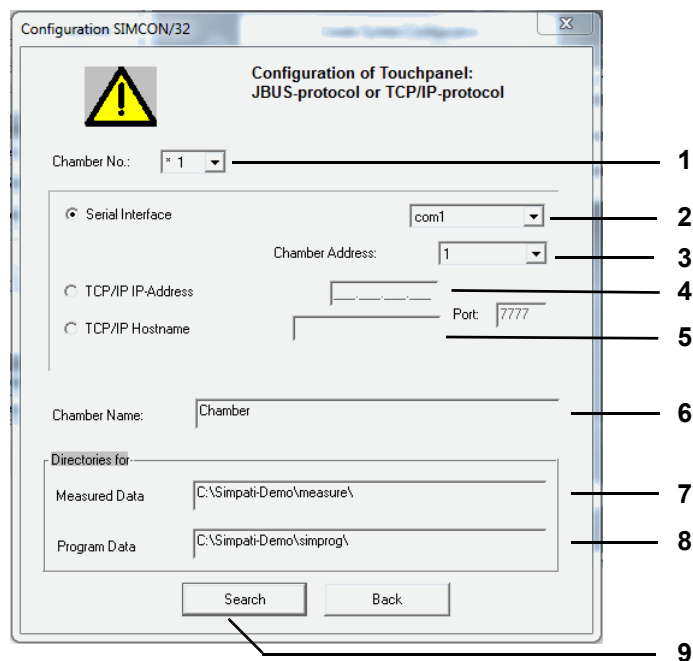

Fig. 3-5: Configuring Mincon / Simcon (Simsetup3K)

- 1 Chamber selection.
All previously configured chambers are marked with an asterisk.
- 2 All available ports are shown automatically.

Interfaces:



It may take a while to search for ports.

- ▶ Use a different port than for the chambers with other controllers.

- 3 Address in the chamber controller → *Appendix: »Chamber controller setup« (page 195)*
- 4 IP address of the chamber.
- 5 Host name of the chamber.
- 6 Chamber designation.

Define the name of the chamber here (max. 20 characters). The name appears in the main menu.
→ *5.1.1 »SIMPATI®'s main screen« (page 50).*

The name can be changed at a later time:
→ *6.1 »General chamber configuration« (page 78).*

- 7 This shows the directory in which the measured data for this chamber are saved.
- 8 This shows the directory in which the test programs for this chamber are saved.
- 9 The system searches via the interface for the chambers connected.

Storing the configuration, see
→ *3.1 »System configuration and registration« (page 30)*

Chambers with data logger

3.3 Chambers with data logger

Make the settings for the chambers in the following menus:

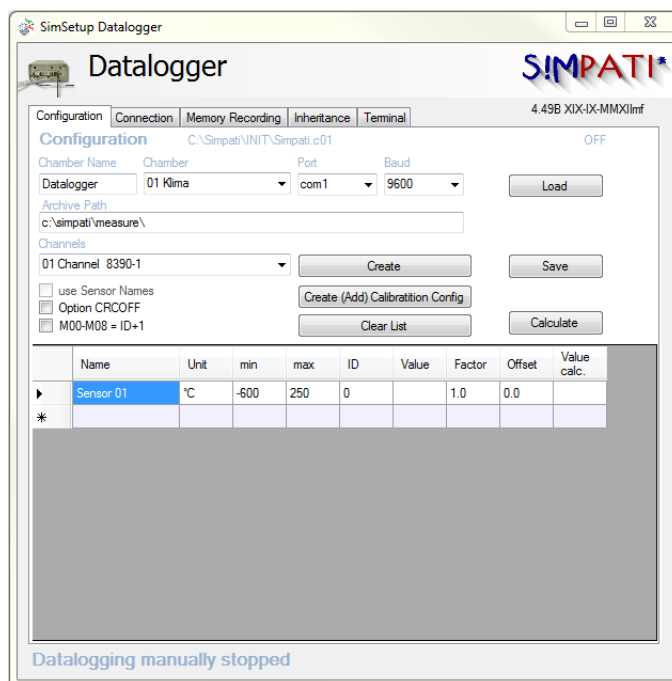

Fig. 3-6: Data logger - Chamber name

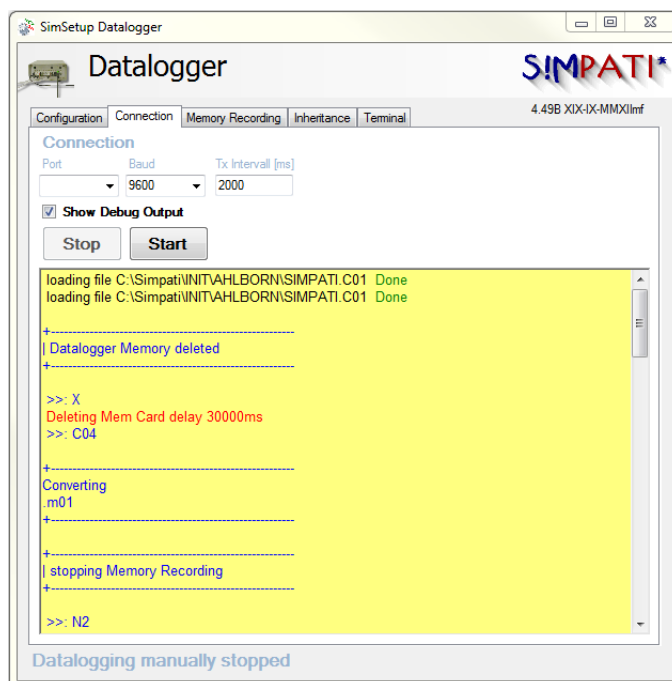

Fig. 3-7: Data logger - Connection

3.4 Configuring chambers with a Simpac controller

Make the settings for the chambers with a Simpac controller in the following menu of the »Simsetup3K« configuration program → (page 28).

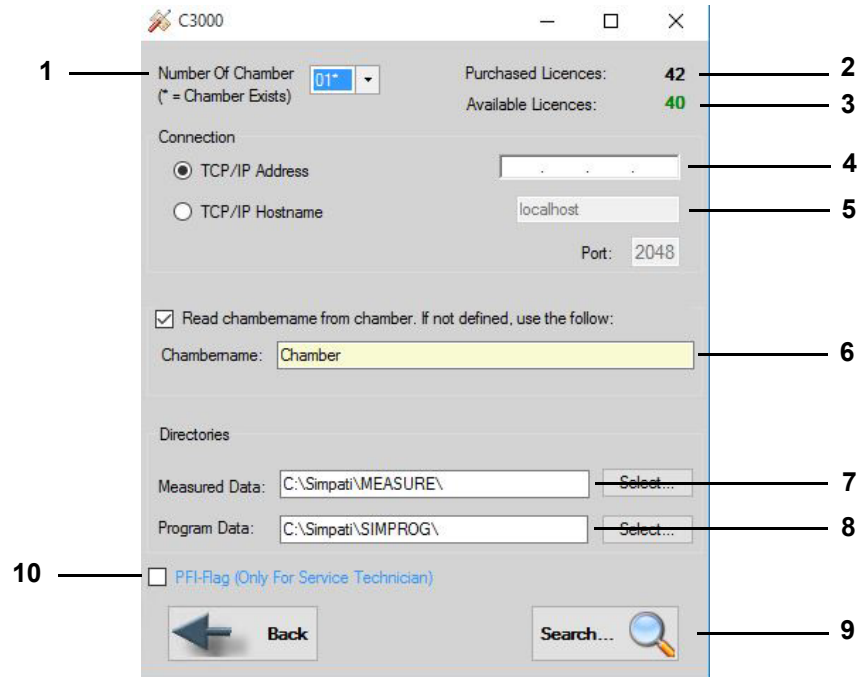

Fig. 3-8: Configuring Simpac (»Simsetup3K«)

- 1 Chamber selection.
All previously configured chambers are marked with an asterisk.
- 2 Total number of licenses purchased.
- 3 Licences not yet assigned to a chamber.
- 4 IP address of the chamber.
- 5 Host name of the chamber.
- 6 Chamber designation.
Define the name of the chamber here (max. 20 characters). The name appears on the main screen:
→ 5.1.1 »SIMPATI®'s main screen« (page 50).
The name can be changed at a later time:
→ 6.1 »General chamber configuration« (page 78).
- 7 This shows the directory in which the test programs for this chamber are saved.
- 8 This shows the directory in which the test programs for this chamber are saved.
- 9 The system searches via the interface for the chambers connected.
Saving the configuration → 3.1 »System configuration and registration« (page 30)
- 10 PFI flag for service personnel only

Configuring chambers with a MOPS / CTC / TC controller

3.5 Configuring chambers with a MOPS / CTC / TC controller

Make the settings for chambers with a MOPS / CTC or TC controller in this menu.

→ *Appendix: »Chamber controller setup« (page 195)*

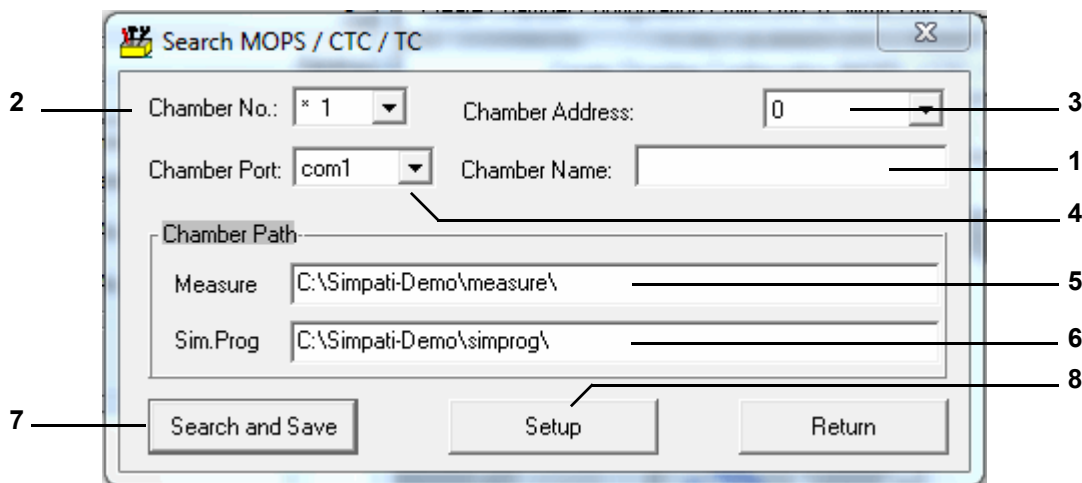

Fig. 3-9: Configuring MOPS / CTC / TC

1 Chamber designation.

Define the name of the chamber here (max. 20 characters). The name appears on the main screen:

→ 5.1.1 »S!MPATI®'s main screen« (page 50).

The name can be changed at a later time:

→ 6.1 »General chamber configuration« (page 78).

2 Chamber selection.

All previously configured chambers are marked with an asterisk.

3 Address in the chamber controller → *Appendix: »Chamber controller setup« (page 195)*

4 Interface.

All available ports are shown automatically.

Interfaces:



It may take a while to search for ports.

- Use a different port than for the chambers with other controllers.

5 This shows the directory in which the measured data for this chamber are saved.

6 This shows the directory in which the test programs for this chamber are saved.

7 The system searches via the interface for the chambers connected.

Saving the configuration:

→ 3.1 »System configuration and registration« (page 30)

8 Specific chamber settings

→ Fig. 3-10: »Settings« (page 37)

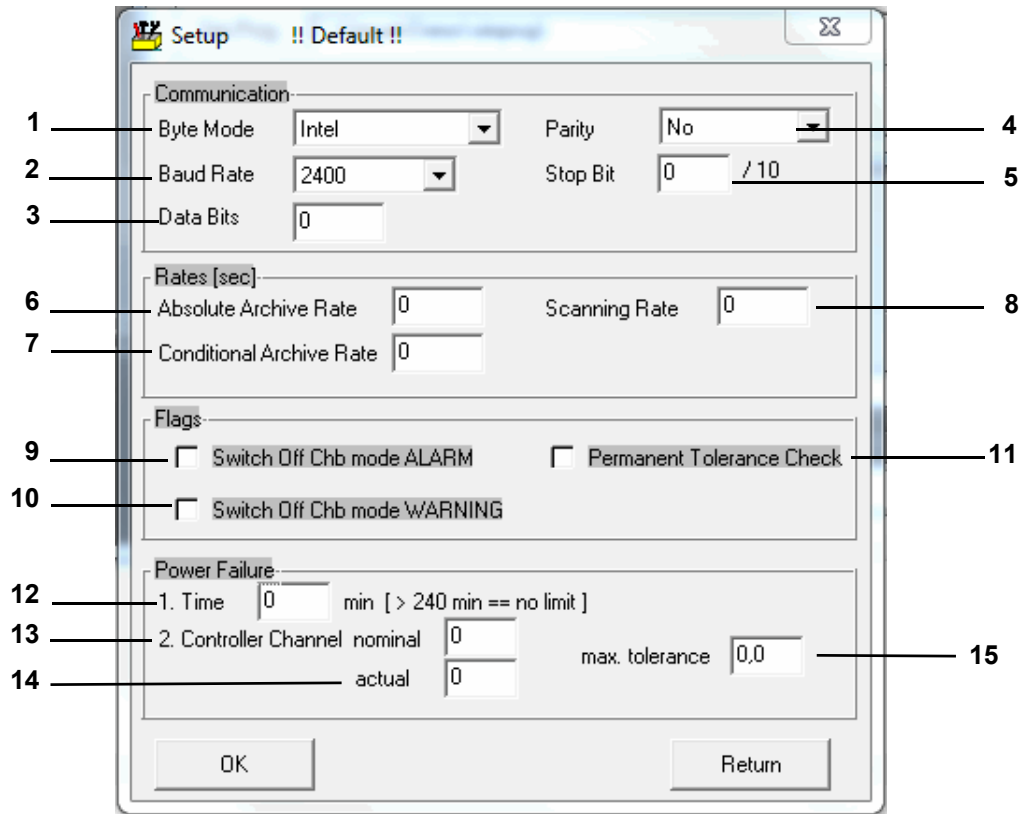

Fig. 3-10: Settings

- 1 Hard disc storage format; default: Intel.
- 2 Transfer speed; default: 9600
- 3 Transfer byte size; default: 8
- 4 Transfer check; default: none
- 5 Transfer stop recognition; default:
Settings other than the defaults above have to be included in the associated documentation.
- 6 Time between two archiving cycles → Fig. 3-10: »Settings« (page 37)
- 7 Conditional archiving cycle.
If the warning limits are exceeded, absolute archiving changes to conditional archiving and continues in this mode. → Fig. 3-10: »Settings« (page 37)
- 8 Chamber information refresh rate.
- 9 An alarm message stops the test.
- 10 A warning message stops the test.
- 11 Continuous query of the tolerance.
- 12 Tolerated maximum power failure time (0-240 min).
If 240 min is entered, an infinite power failure time is tolerated. The test continues after the power failure. To continue archiving, you need to restart the computer.
- 13 Control variable whose nominal value is used for the tolerance calculation, here 1=Temperature.
- 14 Control variable whose actual value is used for the tolerance calculation, here 1=Temperature.
- 15 Tolerated maximum difference between nominal and actual values. The test will not restart at greater differences between nominal and actual values.

Configuring chambers with a DMR controller

3.6 Configuring chambers with a DMR controller

Make the settings for chambers with a DMR controller in this menu.

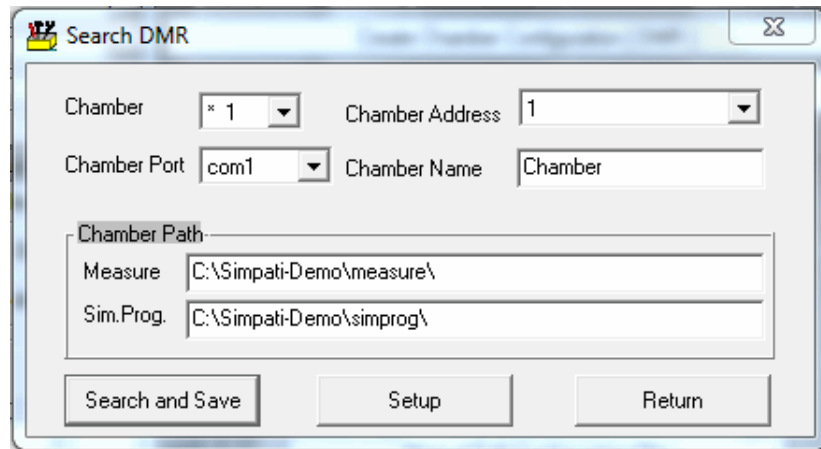

Fig. 3-11: Configuring DMR

The description of this menu corresponds to the descriptions in chapter:

→ 3.5 »Configuring chambers with a MOPS / CTC / TC controller« (page 36)

Specific chamber settings:

→ Fig. 3-10: »Settings« (page 37)

3.7 Configuring chambers with an ISAR controller

Make the settings for chambers with a ISAR controller in this menu.

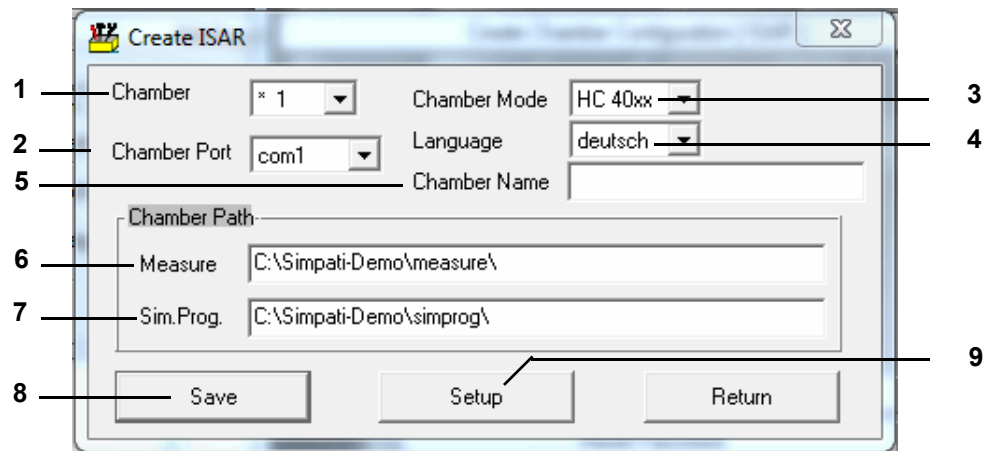

Fig. 3-12: Configuring ISAR

- 1 Chamber selection.
- 2 All available ports are shown automatically.

Interfaces:



It may take a while to search for ports.

- ▶ Use a different port than for the chambers with other controllers.

- 3 Factory type designation of the chamber.
- 4 Language of the chamber controller (the channel names are displayed in this language).
- 5 Define the name of the chamber here (max. 20 characters). The name appears on the main screen:
→ 5.1.1 »SIMPATI®'s main screen« (page 50).
The name can be changed again later on.
- 6 This shows the directory in which the measured data for this chamber are saved.
- 7 This shows the directory in which the test programs for this chamber are saved.
- 8 Save the settings.
- 9 Specific chamber settings.
→ Fig. 3-10: »Settings« (page 37)

Manually editing the configuration data

3.8 Manually editing the configuration data

After entering your password, you may manually edit the configuration files.

ATTENTION

Error while editing the configuration files

- ▶ The changes must only be made by trained service personnel or by arrangement with our Hotline.

→ 1.7 »Service hotline« (page 12)

3.8.1 Initialising the password

Function not available.

3.9 Other controllers, third-party devices and their special features

The controllers and third party devices listed in the next chapters cannot be configured in Simsetup.

You can find the pin assignment for the interface cable in the Appendix:

→ *Appendix: »Patch cable pin assignment« (page 201).*

Instead, a CD containing the appropriate configuration files and an installation manual is supplied with the S!MPATI®. Please follow the instructions in the manual carefully. The following points also apply:

The download and upload functions (transfer of test programs from chamber → PC or PC → chamber) are not supported; in other words, only online operation is possible. Verify that the PC is connected to the chamber at all times.

With the exception of Prodicon Plus and Stange controllers, error messages from the chamber are not displayed in S!MPATI®.

3.9.1 MOPS / CTC / TC controller

Manually enabling/disabling test material protection by software is supported by EPROM version 1.73 or higher.

3.9.2 Gateway with CTC controller

- Automatic test programs cannot be uploaded.
- Background programs are not supported.
- Fast program advance is not supported.
- Test material protection by software cannot be enabled/disabled manually.

3.9.3 ISAR controller

- Simsetup loads the chamber configuration from the Init file, i.e. finding a chamber is no sound evidence of a working communication between the chamber and the software.
- Some digital channels (corrosive gas, radiation, moistening) cannot be set manually.
- Acknowledging errors is not supported.
- Advancing programs is not supported.
- Uploading test programs is not supported.
- Background programs are not supported.
- Test material protection by software cannot be enabled/disabled manually.
- The chamber status can become desynchronised as a result of the chamber being operated from SIMPATI® and from the chamber control unit. Recommendation: The chamber controller should usually be controlled from the control unit or only via SIMPATI®.
- The wait function can be assigned to one channel only.
- Protocol: transparent.

3.9.4 Mincon / Simcon controller

- ▶ Flash version 00.18 or higher supports the upload of test programs.
- ▶ Use the symbolic editor for programming only → 8.2 (page 94)

3.9.5 DMR controller

- ▶ Test programs can only be uploaded with DMR version »R2-38« or higher.
→ 9 »Test program transfer between the chamber and SIMPATI®« (page 151)

3.9.6 Prodicon controller

Make the following settings:

- ▶ Activate the »ON« and »EXT« buttons (both lamps need to light up).
- ▶ Set the address 0 to 31 on the 6-pin DIP switch on the rear of the Prodicon (standard = addr. 1).

Other controllers, third-party devices and their special features

3.9.7 Dicon 50x/100x controller and Imago 500

Make the following settings on the controller:

- Protocol: Modbus
- Parity: none
- Stop bit: 1
- Baud rate: 9600
- Address: 1-32 (standard: 1)

3.9.8 Rotronic Hygroflex 3

Make the following settings on the controller:

- Baud rate: 19200
- Data bits: 7
- Even parity
- Stop bit: 1
- Address: 0

3.9.9 Testa FID2000MP

Make the following settings on the controller:

- Baud rate: 9600
- Data bits: 8
- Odd parity
- Stop bit: 1
- Address: 0



You will need the interface cable and a special software version from Testa!

3.9.10 Stange SE-4xx and 5xx

Make the following settings:

- Baud rate: 19200
- Data bits: 8
- No parity
- Stop bit: 1
- Address: 1



► Adjust the chamber's PLC for operation with SIMPATI®

3.9.11 Prodicon Plus controller

Make the following settings:

- External operation settings:
 - Baud rate: 9600
 - Data bits: 8
 - Parity: none
 - Stop bit: 1

The address you set is the same as the address in SIMPATI®

- ▶ Press »START«. The graphics screen is enabled.

3.9.12 2/3 channel process interface

Make the following settings:

- Left DIP switch: 8 = OFF (RS232 active)
- Right DIP switch: 1, 2, 3 = ON (9600 baud)

3.9.13 QNX controller

Make the following settings:

- ▶ Start external operation (display = External OFF)

3.9.14 Anaprog controller

Make the following settings:

- ▶ Set the baud rate to 2400 baud.
- ▶ Set address 1.
- ▶ You may have to delete the working program at program slot »0«.

3.9.15 SBC controller

Make the following settings:

- Baud rate: 9600
- Data bits: 8
- Parity: none
- Stop bit: 1
- Address: any
- ▶ After switching on the master switch, press the »EXT« button on the controller.

Other controllers, third-party devices and their special features

3.9.16 Eurotherm 900 EPC

Make the following settings:

- Baud rate: 9600
- Data bits: 7
- Parity: odd
- Stop bit: 1
- Address:

3.9.17 Data logger 8590-9C, 8990-6C and 8390-1, 8990-1

→ *Appendix: »Model 8990-6C data logger support« (page 199)*

4 STARTING SIMPATI®

Prerequisites

- SIMPATI® has been installed.
- SIMPATI® has been configured.
- SIMPATI® has at least one fully configured test system to it.

4.1 Starting SIMPATI®

- ▶ Click on the SIMPATI® icon located on the Windows.

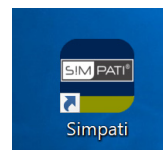

Fig. 4-1: SIMPATI® icon

- ✓ The following prompt pops up if SIMPATI® has not been configured yet:

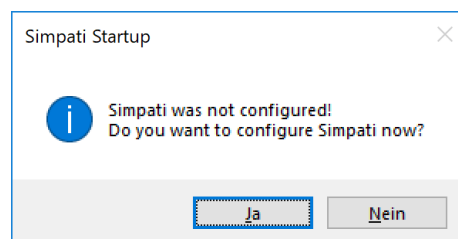

Fig. 4-2: Prompt: SIMPATI® not configured

- ▶ Click on “Yes” and configure SIMPATI®:
 - »To configure SIMPATI®« (page 16)
- ✓ The following prompt pops up if SIMPATI® does not have a configured test system to it:

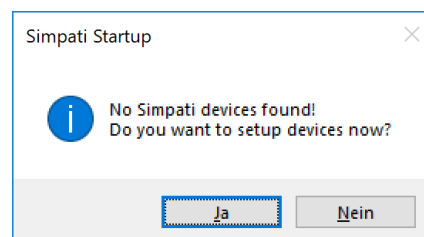

Fig. 4-3: Prompt: Test system not configured

- ▶ Click on “Yes” and configure at least one SIMPATI® test system:
 - »To generate test system configuration files« (page 18)

Starting S!MPATI®

- ✓ Assuming S!MPATI® has been fully installed, the system will link up with the test systems configured and start the S!MPATI® processes.

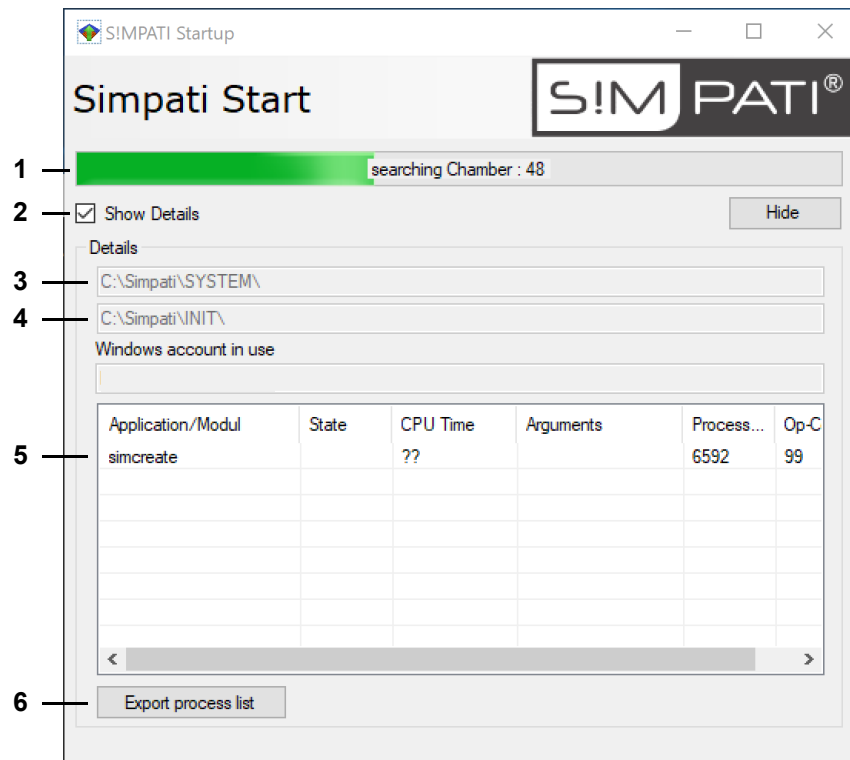

Fig. 4-4: S!MPATI® Start dialog

- 1 Progress of search for test systems.
 - 2 Show/hide start dialog details.
 - 3 S!MPATI® program directory.
 - 4 Directory for test system configuration files.
 - 5 List of S!MPATI® processes.
 - 6 Export list of S!MPATI® processes to a .txt file.
- Wait until the S!MPATI® Login screen appears.

- ▶ Enter your user name and password and click on “Login”.

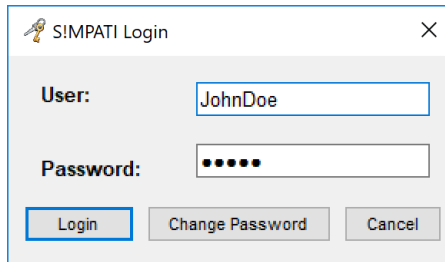

Fig. 4-5: SIMPATI® login



Ask your system administrator for the user name and password. Remember to change the password when logging in for the first time.

- ✓ SIMPATI®'s main screen displays.

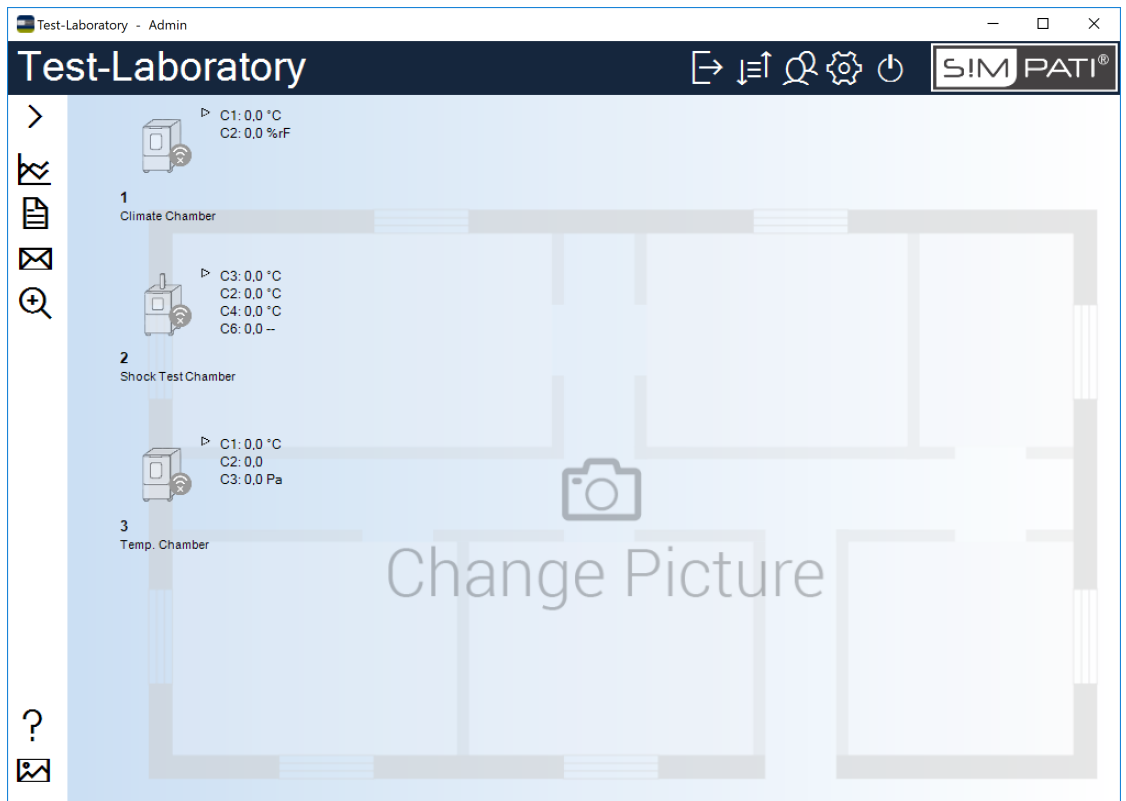

Fig. 4-6: SIMPATI®'s main screen

- ✓ An icon on the task bar allows you to check the status of the SIMPATI® processes while SIMPATI® is running.



Fig. 4-7: Icon: Show SIMPATI® start screen

4.2 S!MPATI® in offline mode

If the PC running S!MPATI® is not connected to the Internet, the system will fail to find certificates of digitally signed .NET applications. This will considerably slow down the start of S!MPATI® because every certificate query will have to time out first.

Use one of the procedure below to speed up the start of S!MPATI® in offline mode:

Method 1: If the PC can temporarily connect to the Internet

- ▶ Establish an Internet connection.
- ▶ Start S!MPATI®.
- ✓ The certificate is cached.
- ▶ Disconnect from the Internet.
- ✓ So long as the certificate is cached, the application starts normally.

The certificate is valid for the current user only.

Method 2: If the PC has to remain offline

- ▶ Pick Windows “Control Panel” → “Network and Internet” → “Internet Options”.
- ▶ Click on the “Advanced” tab, find section “Security” on the “Settings” list and untick the box next to “Check for publisher's certificate revocation”.

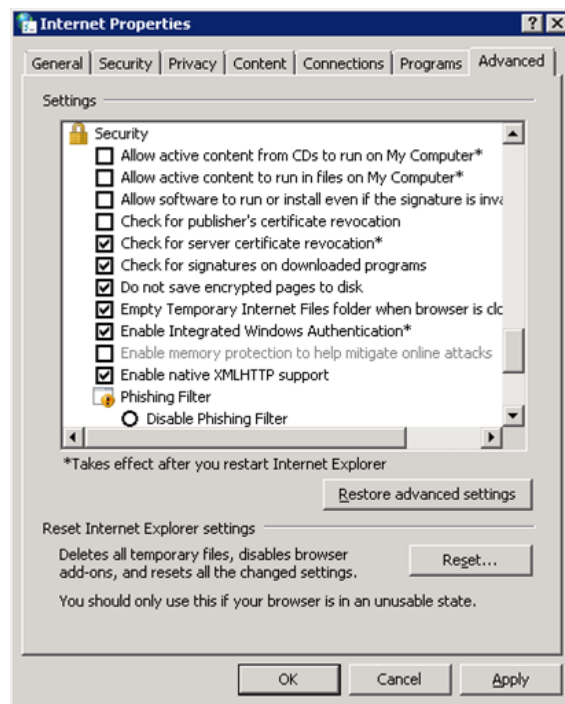

Fig. 4-8: Windows 10: Internet security options

- ▶ Click first on “Apply” and then on “OK”.
 - ▶ Start S!MPATI®.
- The revoked security option is valid for the current user only.

5 S!MPATI® MAIN SCREEN

S!MPATI®'s main screen displays once you have started and logged in to S!MPATI®.

→ 4 »Starting S!MPATI®« (page 45)

5.1 S!MPATI® main screen make-up

The S!MPATI® main screen displays the status of the test systems and provides access to the S!MPATI® functions.

The S!MPATI® functions are organised on the following screens and menus:

→ 5.1.1 »S!MPATI®'s main screen« (page 50)

→ 5.1.2 »Main screen's context menu« (page 52)

→ 5.1.3 »Context menu for test systems« (page 53)

Check the test system icons and the symbols around them to know the status of the test systems.

→ 5.1.4 »Test system icons and shortcuts« (page 55)

SIMPATI® main screen make-up

5.1.1 SIMPATI®'s main screen

The controls in the header of SIMPATI®'s main screen provide global SIMPATI® functions.

The icons on the left of SIMPATI®'s main screen control end user functions.

You can display a user-defined background (such as a test space layout) and place the test system icons wherever you like.

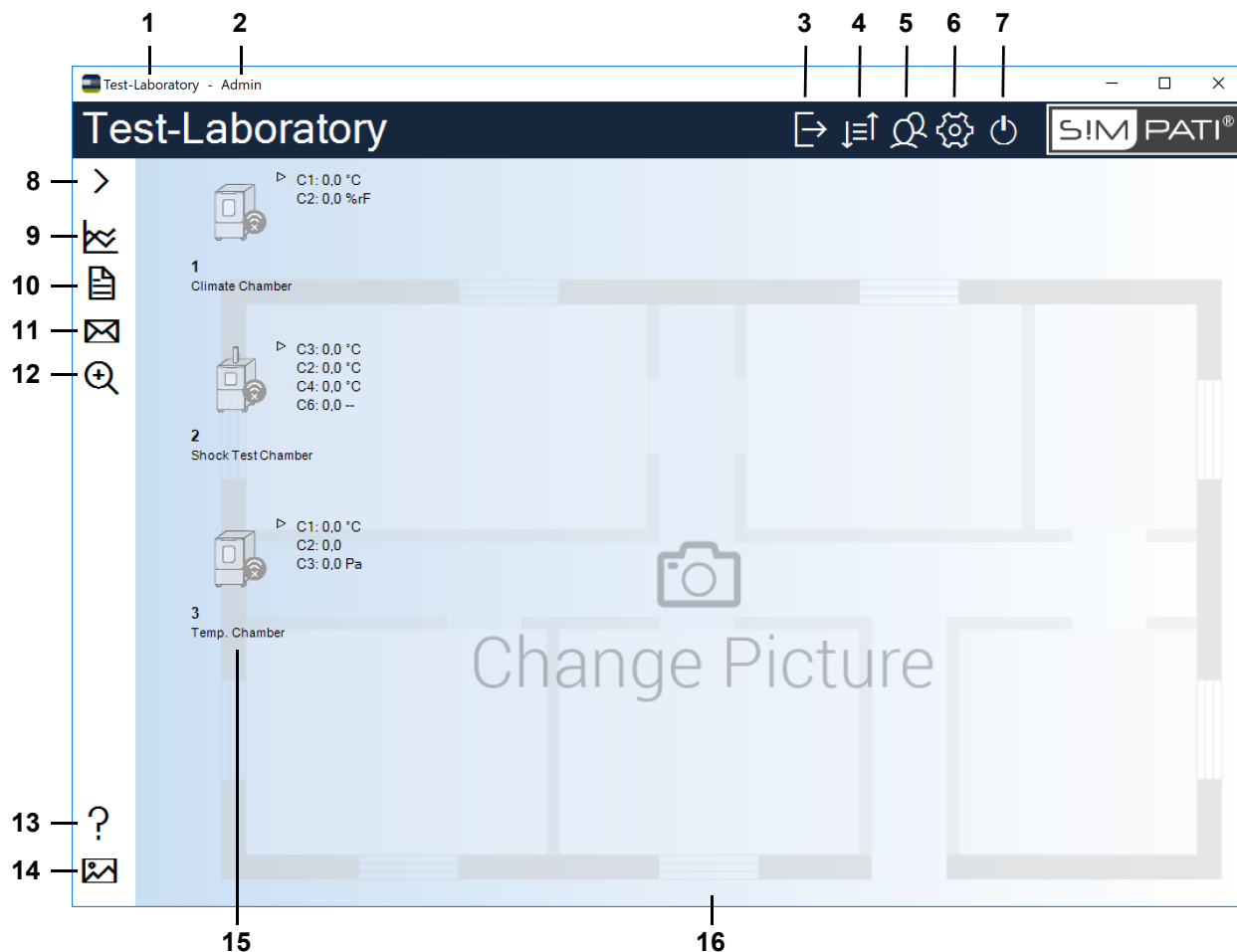

- 1 User-defined SIMPATI® main screen title.
→ 5.5.1 »SIMPATI® settings - configuration« (page 72)
- 2 Name of the currently logged-in user.
- 3 Log in/log off.
→ 5.2 »SIMPATI® user logon/logoff« (page 58)
- 4 Toggle between symbolic and tabular main screen view.
→ 5.3 »Tabular view of main screen« (page 59)
- 5 Administration of users and user rights.
→ 5.4 »User administration« (page 61)
- 6 SIMPATI® Edit settings.
→ 5.5 »SIMPATI® setting« (page 71)

-
- 7 SIMPATI® Exit.
→ 5.6 »*Shutting down SIMPATI®*« (page 75)
 - 8 Show/hide the key to the controls down the left of SIMPATI®'s main screen.
 - 9 Start graphic analysis.
→ 12 »*Graphic analysis*« (page 157)
 - 10 SIMPATI® Show events. You may filter the events to see who was logged in at the time, for example.
→ 13 »*Chamber reports and messages (Simreport)*« (page 185)
 - 11 Configure SimMailer. Run SimMailer to automatically send e-mails with up-to-date test system details such as on warning and alarms.
→ 14 »*Automatic generation of e-mail messages in SIMPATI®*« (page 187)
 - 12 Browse the network for other test systems. Before working with newly found test systems, you must first configure them in SIMPATI®.
→ 6 »*Chamber configuration*« (page 77)
 - 13 SIMPATI® Display the user guide.
 - 14 Choose another background image for SIMPATI®'s main screen. Choose from the available images or your own background image, e.g. the test lab layout.
→ 5.5.1 »*SIMPATI® settings - configuration*« (page 72)
 - 15 Icons representing the test systems and showing the test system status and its key control variables.
→ 5.1.4 »*Test system icons and shortcuts*« (page 55)

Test system icons will not scale automatically when you change the size of the main screen. To know how to change the icon size, go to the chapter below:

→ 5.1.3 »*Context menu for test systems*« (page 53), "Options"
 - 16 Background image (wallpaper).

You may move the test system icons to any place on the background image as follows: press and hold the Ctrl key on your keyboard, pick up the test system icon with the mouse and drag it to another place.

The background image will not scale automatically when you change the size of the main screen.

SIMPATI® main screen make-up

5.1.2 Main screen's context menu

Right-click on the main screen (but not on any of the controls or test system icons) to show the main screen's context menu:

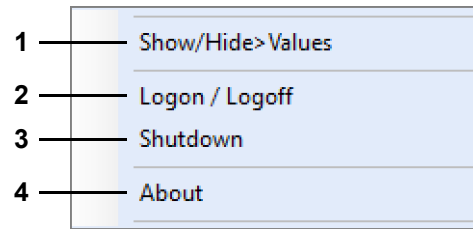

Fig. 5-2: Main screen's context menu

- 1 Show/hide the values next to the test system icons.
- 2 Log in/log off.
→ 5.2 »SIMPATI® user logon/logoff« (page 58)
- 3 SIMPATI® Exit.
→ 5.6 »Shutting down SIMPATI®« (page 75)
- 4 Show the SIMPATI® release number and licence information.

5.1.3 Context menu for test systems

Right-click on a test system icon on the main screen to show the context menu for test systems.

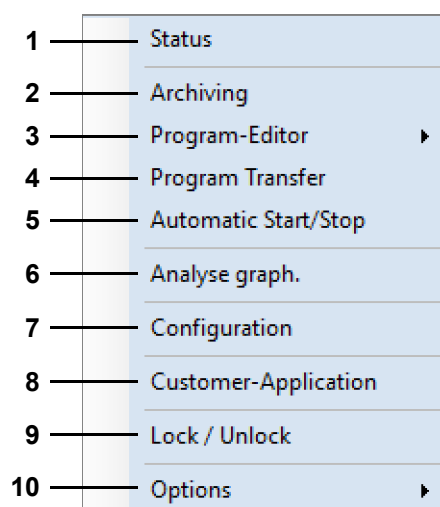

Fig. 5-3: Context menu for test systems

- 1 Show the test system status (for operation in manual mode).
→ 7 »Manual mode and chamber status« (page 85)
- 2 Save test sequence and measured data.
→ 11 »Archiving« (page 155)
- 3 Create a test program.
→ 8.2 »Using the symbol editor to create test programs« (page 94)
→ 8.3 »Using the graphic editor to create test programs« (page 112)
→ 8.4 »Using the tabular editor to create test programs« (page 127)
→ 8.5 »Creating test programs for a shock test chamber« (page 138)
- 4 Transfer a test program to the test system controller and run it.
The storage locations in the test system controller can hold up to 100 test programs.
→ 9 »Test program transfer between the chamber and SIMPATI®« (page 151)
- 5 Start/stop a test program stored in the test system.
→ 10 »Starting / stopping a test program« (page 153)
- 6 Start graphic analysis.
→ 12 »Graphic analysis« (page 157)
- 7 Configure the interface and the test system parameters.
→ 6 »Chamber configuration« (page 77)
- 8 Start the customer application.
A customer application is a program module you will run frequently and that you specified when configuring the test system, e.g. *SimStatus* for showing the test process status.
→ 6.1 »General chamber configuration« (page 78)

SIMPATI® main screen make-up

Another approach to run the customer application is to double-click on the test system icon.

- 9 Lock/unlock the use of the test system in SIMPATI®.
- 10 Set the size of test system icons and show or hide the actual values otherwise appearing next to a test system icon.

5.1.4 Test system icons and shortcuts

In its symbolic view, SIMPATI®'s main screen displays icons representing the test systems. Major test system details are grouped around every icon.

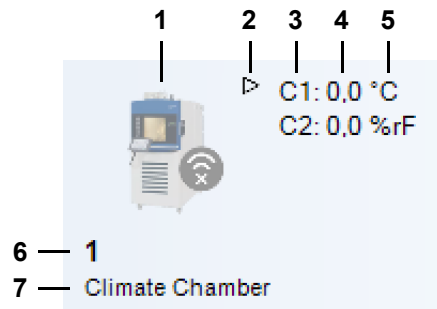

Fig. 5-4: Test system icon with test system details

1 Test system icon.

The test system icon tells you whether the test system is ready or whether there is an active warning/alarm.

→ »Test system icons« (page 56)

Pick the icon matching your test system.

→ 6.1 »General chamber configuration« (page 78)

Right-clicking on the test system icon displays the context menu and its test system function items.

→ 5.1.3 »Context menu for test systems« (page 53)

Double-clicking on the test system icon runs the customer application you specified when configuring the test system.

2 Click on this control to show or hide the actual values of the test system's control variables.

Up to the first four control variables are shown.

3 Control variable ID.

4 Actual value of control variable.

5 Physical unit of control variable.

6 Test system ID.





7 Test system name.

Read the section below to find explanations of other icons appearing around the test system icon:

→ »Other icons around test system icons« (page 57)

SIMPATI® main screen make-up

Test system icons

Test system icon	Explanation
	Test system is offline and does not communicate with SIMPATI®.
	Test system is ready.
	Normal operation, test system is running (in manual or automatic mode).
	Warning.
	Alarm.

Tab. 5-1: Test system icons

You may pick one of the available or your own test system icon. Display the following dialog to define the test system icons.

→ 6.1 »General chamber configuration« (page 78)

Display the following dialog to define icon sizes and positions:





→ 5.5.2 »SIMPATI® settings - view« (page 74)

Test system modes

Abbreviation	Explanation
M	Test is running in manual mode.
A	Test is running in automatic/program mode.
P	Test program interrupted.
B	Busy (status) with downloading or uploading, for example.
D	SIMPATI® Used only for data acquisition only.
W	Waiting for start mode.

Tab. 5-2: Test system modes

Other icons around test system icons

Icon	Explanation
	Archiving in progress.
	Test system locked by the user currently logged in to SIMPATI®.
	Test system locked by a client, e.g. by SIMPATI® Web. Point your mouse to the icon to display a tooltip showing the user name and IP address of the PC that locked the test system.
	Test system locked locally. Both the tooltip and the chamber details tell you the name of the locking person/unit.
	Test system running in internal mode, i.e. it can be operated at the device only.

Tab. 5-3: Other icons around test system icons

5.2 SIMPATI® user logon/logoff



Click on this icon on SIMPATI®'s main screen to log on to or off from SIMPATI®.

→ 5.1.1 »SIMPATI®'s main screen« (page 50)

You will need your user name and password. Contact your administrator if your credentials are not at hand.

To log on to SIMPATI®

- ▶ Click on .
- ▶ Enter your user name and password and click on "Login".

Fig. 5-5: SIMPATI® login

- ✓ You can now access the test system and SIMPATI® functions user administration privileged you to use.

→ 5.4 »User administration« (page 61)



Only one user at a time can be logged in to SIMPATI®. The report file keeps track of who logged in and off.

To log off from SIMPATI®

- ▶ Click on  again.
- ✓ SIMPATI® will keep running after you logged off.
- ✓ All test system functions are locked.



Logging off is one way of safeguarding the test systems and processes against unauthorised access.

5.3 Tabular view of main screen



Click on this icon on SIMPATI®'s main screen to toggle between the symbolic and tabular views.

→ 5.1.1 »SIMPATI®'s main screen« (page 50)

To enable the tabular view

► Click on .

- ✓ The main screen appears as a table.
- ✓ Its header and icons remain unchanged.

1	2	3	4	5	6	7	8	9	10
Idx	Unit	Mode	Value	Program	Archive	State	Type	Device	Profiles
01	Climate Chamber		0,00			08	33333	com1, 1	CV02 SP01 MV02 Mval00
02	Shock Test Chamb...		0,00			08	33333	com1, 7	CV06 SP02 MV02 Mval00
03	Temp. Chamber		0,00			08	33333	com1, 1	CV03 SP01 MV04 Mval00

- 1 Test system ID.
- 2 Test system name.
- 3 Current mode (e.g. **A** = Automatic mode).
→ »Test system modes« (page 56)
- 4 Value of the first test system control variable (control variable ID = 1).
→ 6.3 »Setting profiles/limits« (page 81)
- 5 Test program name (automatic mode only).
- 6 Destination file for archiving the measured data.
- 7 Test system status.
- 8 Test system type code.

Tabular view of main screen

9 PC port used to access the test system.

10 Test profile name.



-
- Press the "+" and "-" keys on your numeric keypad to zoom in or out of the table.
 - Click on a column header to sort the table by this column.
-

To enable the symbolic view

- ▶ Click on  again.
- ✓ The main screen shows symbols.

5.4 User administration



User administration is accessed by clicking on this icon on SIMPATI®'s main screen.

→ 5.1.1 »SIMPATI®'s main screen« (page 50)

User administration allows you to create SIMPATI® users. Every user is assigned a user name and password. User administration also lets you assign system and chamber rights to every user to specify what exactly they are allowed to do with SIMPATI® and the test systems.

Users can be put into user groups. This is a practical means of assigned the same set of access rights to several users. In this case, you assign the rights at group level. Every user in a group will automatically share the same rights.

Apart from the group rights, group members can be assigned or withdrawn rights at individual level.

There are overview screens that make it easier to keep track of who is allowed to do what.

Standard procedure of creating users and assigning user rights

- ▶ Click on .
- ✓ User administration starts.
 - 5.4.1 »Start screen of user administration« (page 62)
- ▶ Create a group.
 - 5.4.7 »Creating user groups« (page 68)
- ▶ Set the group's passwords, system and chamber rights.
 - 5.4.9 »Set a group's passwords, system and chamber access rights« (page 69)
- ▶ Create and assign users to the group.
 - 5.4.2 »Creating users« (page 63)
- ✓ Every user owns the group's password settings, system and chamber rights.
- ▶ Override a user's inherited rights, as appropriate.
 - 5.4.4 »Changing the password settings« (page 65)
 - 5.4.5 »Editing the system access rights« (page 66)
 - 5.4.6 »Editing the chamber access rights« (page 67)

User administration

5.4.1 Start screen of user administration

“SIMPATI®’s main screen” → 

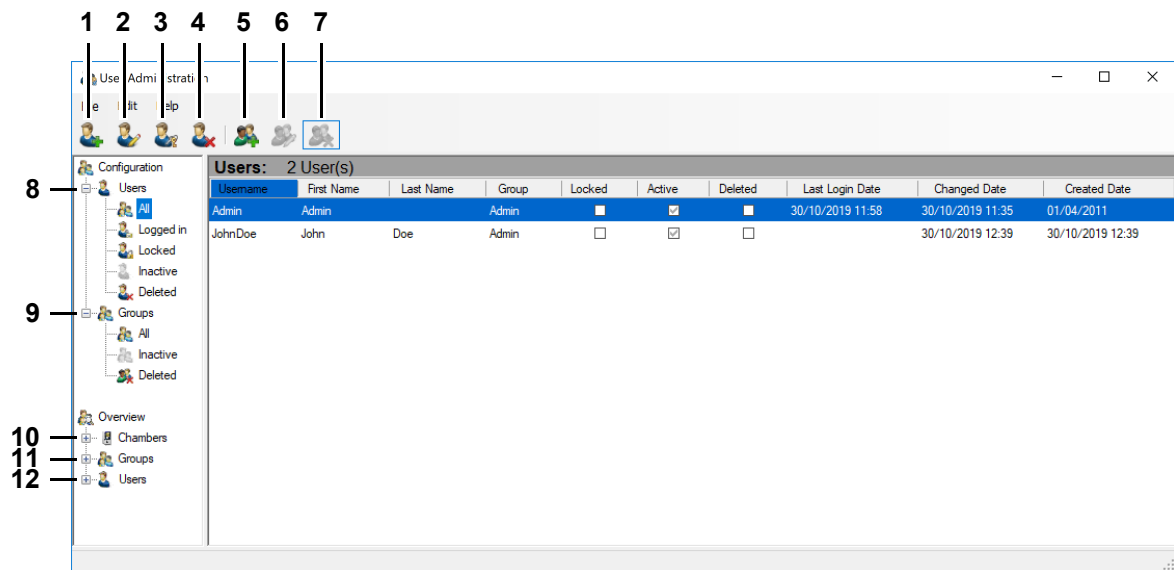



Fig. 5-7: Start screen of user administration

- 1 Create new user.
→ 5.4.2 »Creating users« (page 63)
- 2 Edit a user’s general details, password settings, system and chamber rights.
→ 5.4.3 »Editing general user data« (page 64)
→ 5.4.4 »Changing the password settings« (page 65)
→ 5.4.5 »Editing the system access rights« (page 66)
→ 5.4.6 »Editing the chamber access rights« (page 67)
- 3 Change a user’s password.
- 4 Delete user.
- 5 Create new group.
→ 5.4.7 »Creating user groups« (page 68)
- 6 Set a group’s passwords, system and chamber rights.
→ 5.4.9 »Set a group’s passwords, system and chamber access rights« (page 69)
- 7 Delete group.
- 8 User lists: users are filtered by various criteria such as “logged in” or “locked”.
- 9 Group lists: groups are filtered by various criteria such as “inactive” or “deleted”.
- 10 Overview of test systems: Who is allowed to do what with a specific test system?
- 11 Overview of groups: Which set of rights does a group of users own?
- 12 Overview of users: Which system and chamber rights does a single user own?

5.4.2 Creating users

“SIMPATI®’s main screen” →  → “New user”

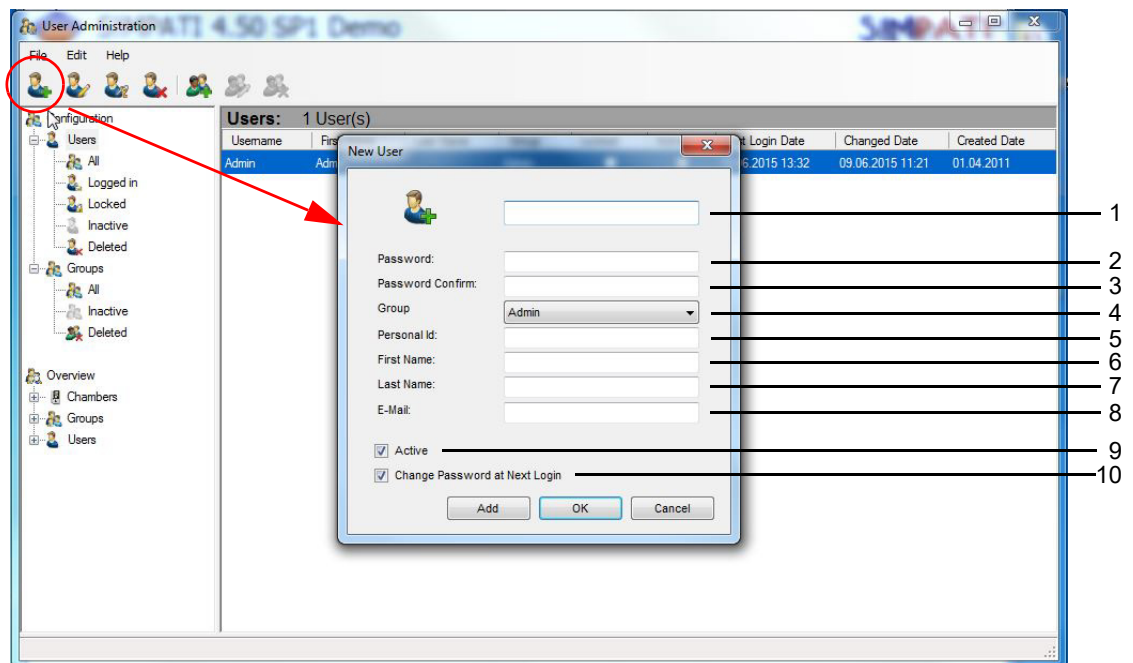
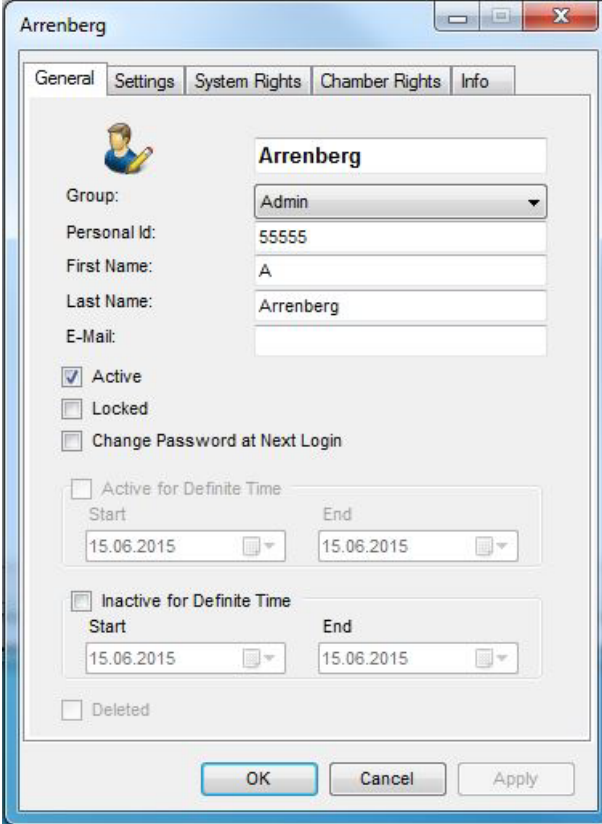

Fig. 5-8: User administration - new user

- 1 Set a user name.
- 2 Specify a password.
- 3 Repeat password.
- 4 Assign user to a group (a user can belong to not more than a single group).
- 5 Enter payroll number (optional).
- 6 Enter first name (optional).
- 7 Enter last name (optional).
- 8 Enter e-mail address (optional).
- 9 Activate/deactivate user.
- 10 The next time the user logs in they must change the password assigned by the administrator.

User administration**5.4.3 Editing general user data**

“SIMPATI® main screen” →  → “Edit user” → “General” tab



The screenshot shows a dialog box titled "Arrenberg" with a "General" tab selected. The dialog contains the following fields and options:

- Group:** Admin (dropdown menu)
- Personal Id:** 55555
- First Name:** A
- Last Name:** Arrenberg
- E-Mail:** (empty text field)
- Active
- Locked
- Change Password at Next Login
- Active for Definite Time
 - Start: 15.06.2015
 - End: 15.06.2015
- Inactive for Definite Time
 - Start: 15.06.2015
 - End: 15.06.2015
- Deleted

Buttons at the bottom: OK, Cancel, Apply.

Fig. 5-9: User administration - Edit general user data

The section below describes what the items are there for:

→ 5.4.2 »Creating users« (page 63)

5.4.4 Changing the password settings

“SIMPATI® main screen” →  → “Edit user” → “Settings” tab

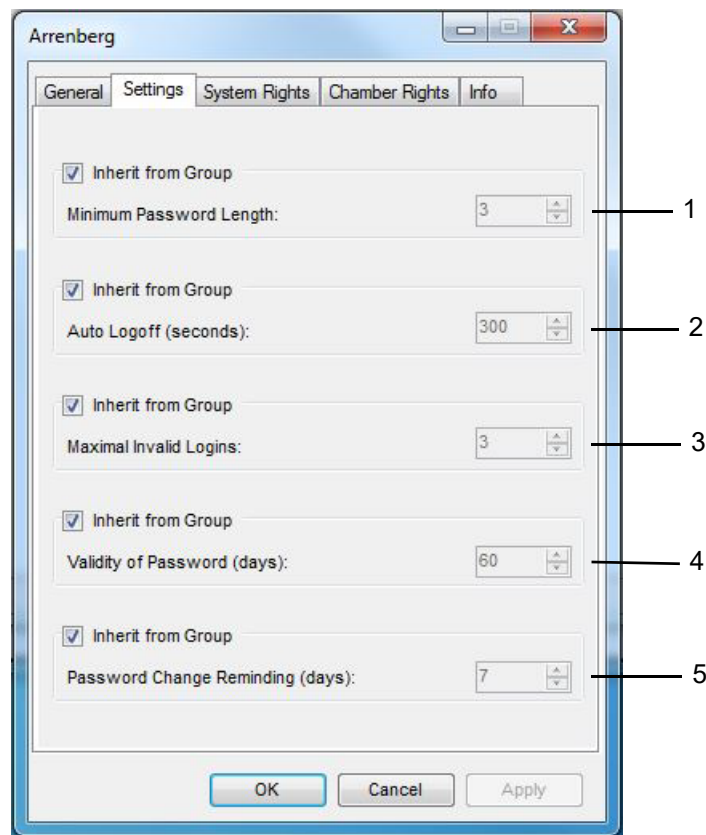

Fig. 5-10: User administration - Change password settings

- 1 Valid passwords are between 1 and 30 characters long.
In the pharma variant, passwords must be at least 8 characters long and must not have been used as passwords before. Characters have to be of at least three of the following categories: lowercase, uppercase, special characters, numerals.
- 2 Users will automatically be logged off after the specified period of inactivity.
In the pharma variant, the time is set to 5 minutes in the factory and can be changed to anything between 40 and 300 seconds only.
- 3 You may allow up to 30 invalid login attempts.
In the pharma variant, the number of invalid login attempts is limited to 3.
- 4 Passwords can remain valid for 1 to 1000 days.
In the pharma variant, the validity period is limited 1 to 100 days.
- 5 Number of early warning days users are alerted to changing their password before it turns invalid.

Further information

→ *Appendix: »Installation for operation in pharmaceutical environments« (page 243)*

User administration

5.4.5 Editing the system access rights

“SIMPATI® main screen” →  → “Edit user” → “System rights” tab

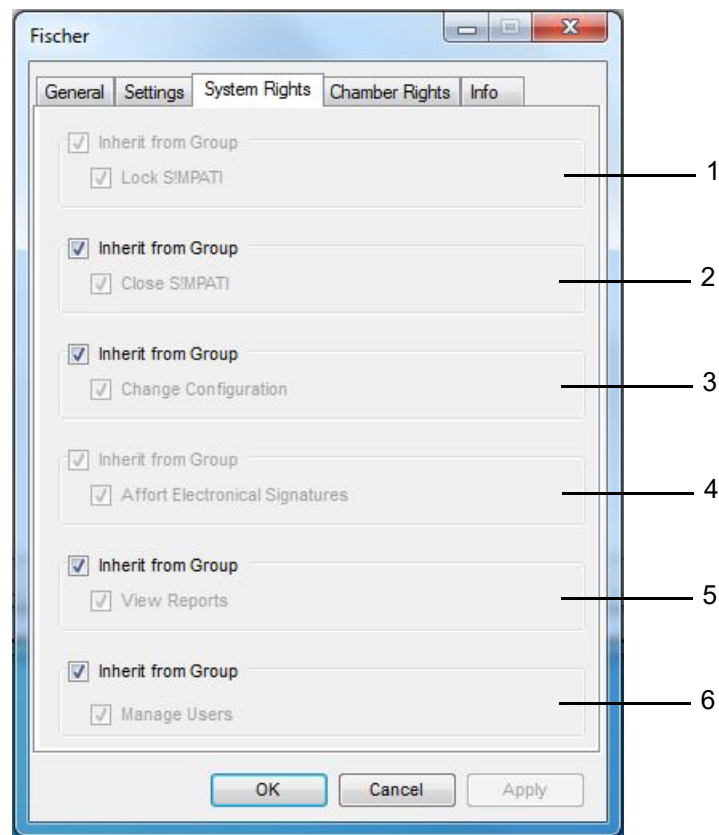



Fig. 5-11: Use administration - Edit system rights

Ticked options allow users to:

- 1 Lock SIMPATI®. A password is required for the next access.
- 2 SIMPATI® Exit.
- 3 Change SIMPATI® system configuration.
→ 5.5 »SIMPATI® setting« (page 71)
- 4 Sign electronically (optional).
- 5 Show reports.
- 6 Manage users.

5.4.6 Editing the chamber access rights

“SIMPATI® main screen” →  → “Edit user” → “Chamber rights” tab

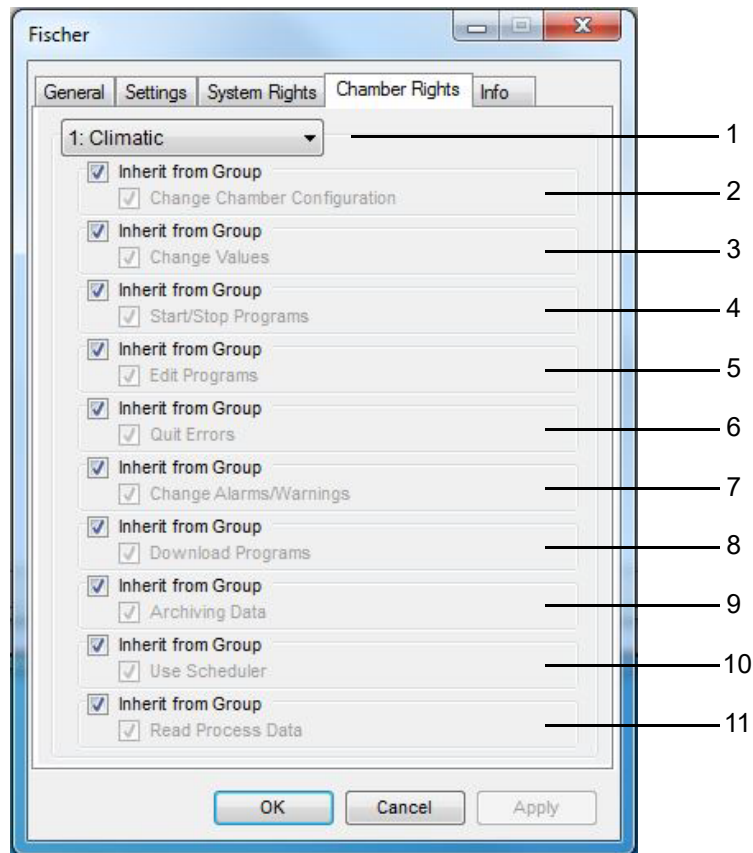



Fig. 5-12: Use administration - Edit chamber rights

Ticked options allow users to:

- 1 Select a test system.
- 2 Change the test system configuration.
→ 6 »Chamber configuration« (page 77)
- 3 Change nominal and control values and digital channels.
- 4 Start and stop programs.
- 5 Create programs.
- 6 Acknowledge error messages.
- 7 Change alarm and warning limits.
- 8 Transfer programs.
- 9 Archive data.
- 10 SIMPATI® v4.70 or higher is supplied without this module.
- 11 Run graphic analysis.

User administration

5.4.7 Creating user groups

“SIMPATI®’s main screen” →  → “Add group”

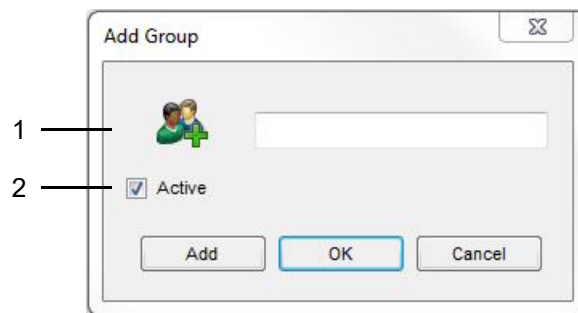



Fig. 5-13: User administration - Add group

- 1 Enter group name.
- 2 Activate / deactivate group.

5.4.8 Editing general group data

“SIMPATI® main screen” →  → “Edit group” → “General” tab

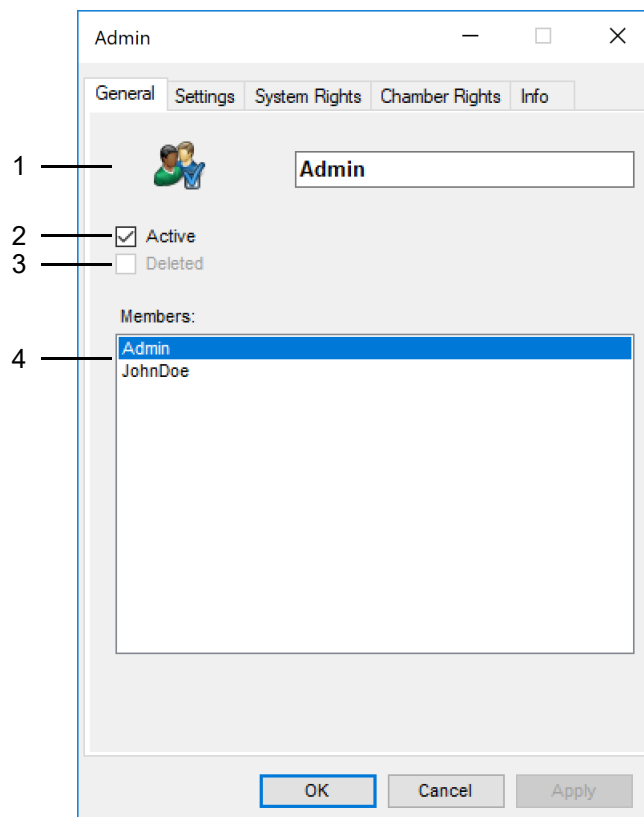





Fig. 5-14: User administration - General group data

- 1 Edit group name.
- 2 Activate / deactivate group.
- 3 Group deleted.
- 4 Users belonging to this group.

5.4.9 Set a group's passwords, system and chamber access rights

"SIMPATI® main screen" →  → "Edit group" → "Settings" tab

"SIMPATI® main screen" →  → "Edit group" → "System rights" tab

"SIMPATI® main screen" →  → "Edit group" → "Chamber rights" tab

Editing a group's passwords, system and chamber access rights is identical to changing user rights:

→ 5.4.4 »*Changing the password settings*« (page 65)

→ 5.4.5 »*Editing the system access rights*« (page 66)

→ 5.4.6 »*Editing the chamber access rights*« (page 67)

User administration

5.4.10 Edit menu

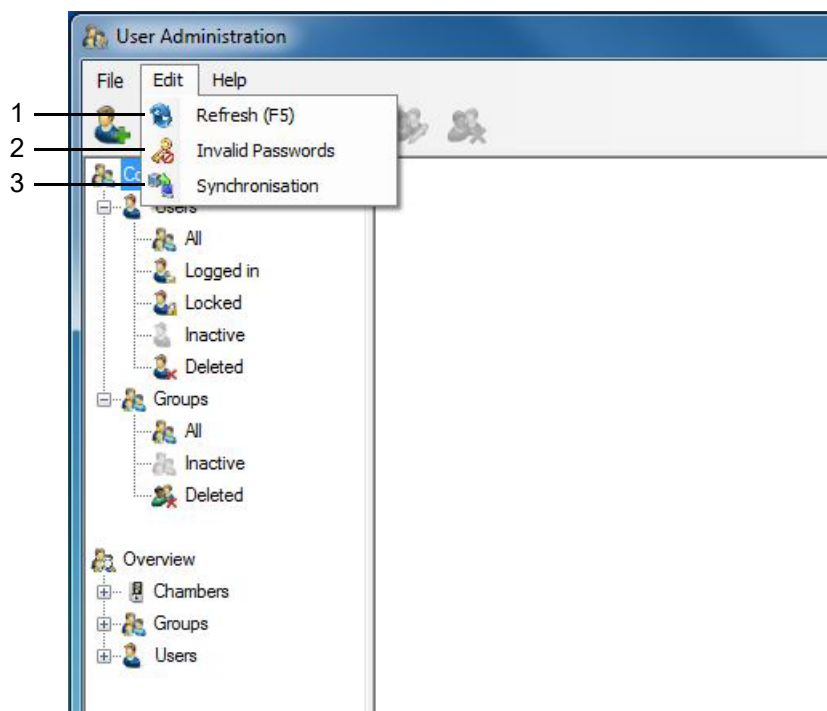

Fig. 5-15: Use administration - Edit menu

- 1 Refresh view.
- 2 Exclude passwords.
- 3 Transfer of user data and user access rights to the control unit of the test system selected.

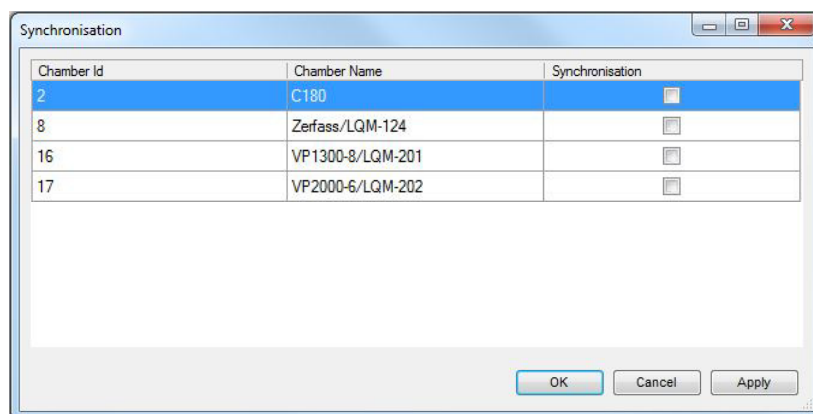

Fig. 5-16: User administration - Synchronisation

- The control unit will not display the data until the test system has been restarted (master switch Off/On) after synchronisation.
- Expired passwords can only be changed in SIMPATI® User Administration.
- The validity of control unit passwords is not monitored, the reason being that, otherwise, operating the test system may not work properly when the control unit and the SIMPATI® PC are not communicating.

5.5 SIMPATI® setting



Click on this icon on SIMPATI®'s main screen to edit the SIMPATI® settings.

→ 5.1.1 »SIMPATI®'s main screen« (page 50)

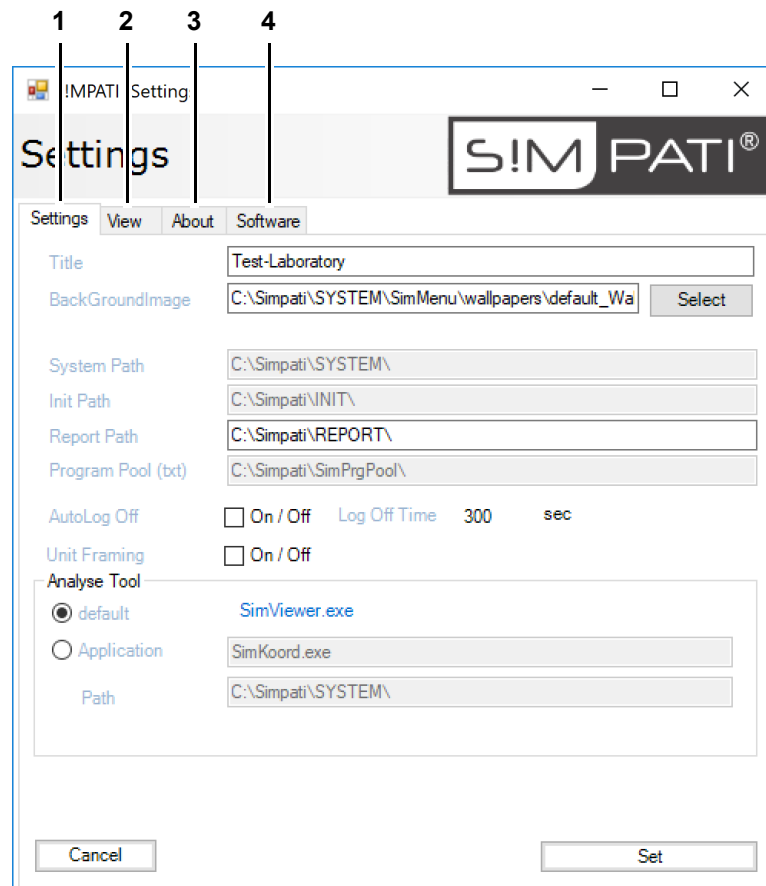

Fig. 5-17: SIMPATI® settings dialog

This dialog has the following tabs:

- 1 Configure the main screen and change other SIMPATI® settings.
→ 5.5.1 »SIMPATI® settings - configuration« (page 72)
- 2 Set the arrangement of test system icons on the main screen.
→ 5.5.2 »SIMPATI® settings - view« (page 74)
- 3 SIMPATI® release number and licence information.
- 4 SIMPATI® software details.

5.5.1 SIMPATI® settings - configuration

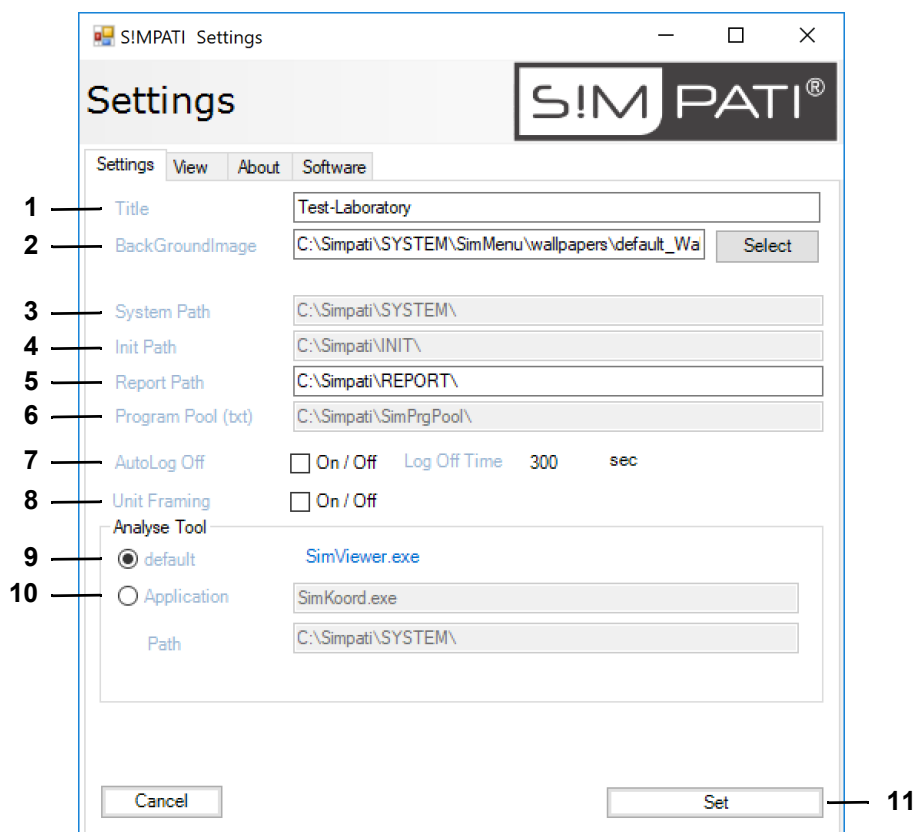

Fig. 5-18: SIMPATI® settings - configuration

- 1 Enter a main screen title.
- 2 Choose background image for the main screen.
Click on “Select” to choose a background image such as you own image showing the layout of your test lab.
Do not fill in this box if you do not wish to show a background image.
- 3 SIMPATI® program directory.
- 4 Directory for test system configuration files.
- 5 Reports directory.
- 6 Test programs directory.
- 7 Disable automatic logoff by SIMPATI®.
If this option is ticked, you will log off after the set time of SIMPATI® inactivity.
Go to User Administration to find or change the automatic logoff timeout.
→ 5.4.4 »Changing the password settings« (page 65)
The pharma variant will always log you off after the set time.
- 8 Put a frame around the test system icons shown on the main screen.

- 9 By default, SIMPATI® v4.70 or higher features a “SimViewer” module. Releases up until v4.80 will also support its predecessor, “SimKoord”.
→ 12 »*Graphic analysis*« (page 157)
- 10 Filename and directory of the alternative application.
- 11 Accept changed settings.

5.5.2 SIMPATI® settings - view

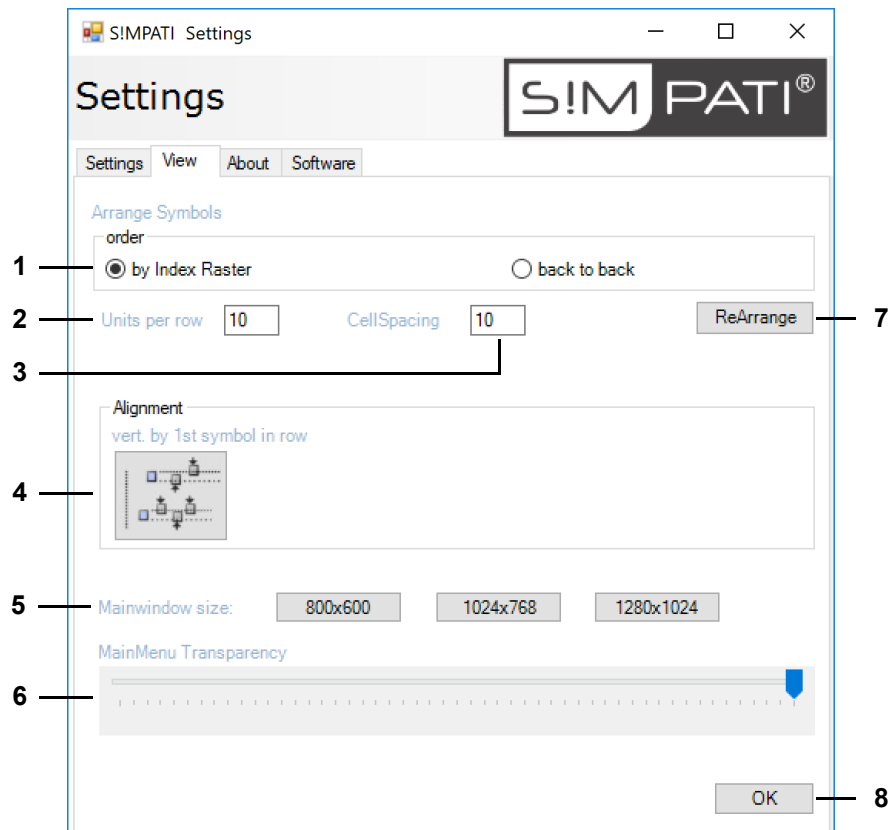

Fig. 5-19: SIMPATI® settings - view

- 1 Set the arrangement of test system icons:
 - “by Index Raster”: The arrangement of test system icons will use the pattern set in the factory.
 - “back to back”: Test system icons will be arranged from left to right and line by line from top to bottom, sorted by their consecutive IDs.
- 2 Number of test system icons per line.
- 3 Number of pixels between test system icons (horizontal and vertical).
- 4 If you opt against arranging the icons in a pattern or back to back, double-click on this icon to vertically move the test system icons until they are aligned with the first test system icon in the line. This will move test system icons only if their position overlaps the line after the first icon.
- 5 Set the size of the main screen.
- 6 Set the transparency of the main screen.
- 7 Rearrange the test system icons on the main screen in order to check the effect of the current settings.
- 8 Confirm your changes and close the dialog.



You may move the test system icons to any place on the main screen as follows: press and hold the Ctrl key on your keyboard, pick up the test system icon with the mouse and drag it to another place.

5.6 Shutting down S!MPATI®



Click on this icon on S!MPATI®'s main screen to shut down S!MPATI®.

→ 5.1.1 »S!MPATI®'s main screen« (page 50)

To exit S!MPATI®

- ▶ Click on .
- ▶ Click on "Yes".

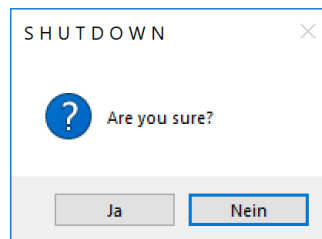

Fig. 5-20: Exit S!MPATI®

- ▶ Wait until S!MPATI® has terminated all processes.

Shutting down SIMPATI®

6 CHAMBER CONFIGURATION

Be sure to be familiar with the terminology below before you configure the chamber:

Term	Explanation
Control variable	The test system uses control variables to set physical quantities such as the temperature or the relative humidity to user-defined nominal values and to maintain these. The test system outputs a warning/alarm whenever the actual reading of a control variable is off the set limits.
Control value	The test system uses control values to actuate certain test system functions such as the fan speed. It does not return a signal to say whether the value is actually obtained.
Measured value	Apart from the control variables, the test system can measure other physical quantities such as the temperature inside the test space. This does without setting a nominal value. The test system outputs a warning/alarm whenever the actual reading is off the set limits.
Counter	The test system can also output operation-related values such as the test system's operating hours.
Digital channel/output	A digital channel/output can be used to enable or disable a specific test system function such as extracting exhaust gases or supplying compressed air. Customer-specific digital channels may be added.
Digital channel/input	Another test system can use a digital channel/input to influence the test process.

Tab. 6-1: Chamber configuration terminology

General chamber configuration

6.1 General chamber configuration

Use the context menu of the test systems to access this menu.

→ 5.1.3 »Context menu for test systems« (page 53), “configuration”.

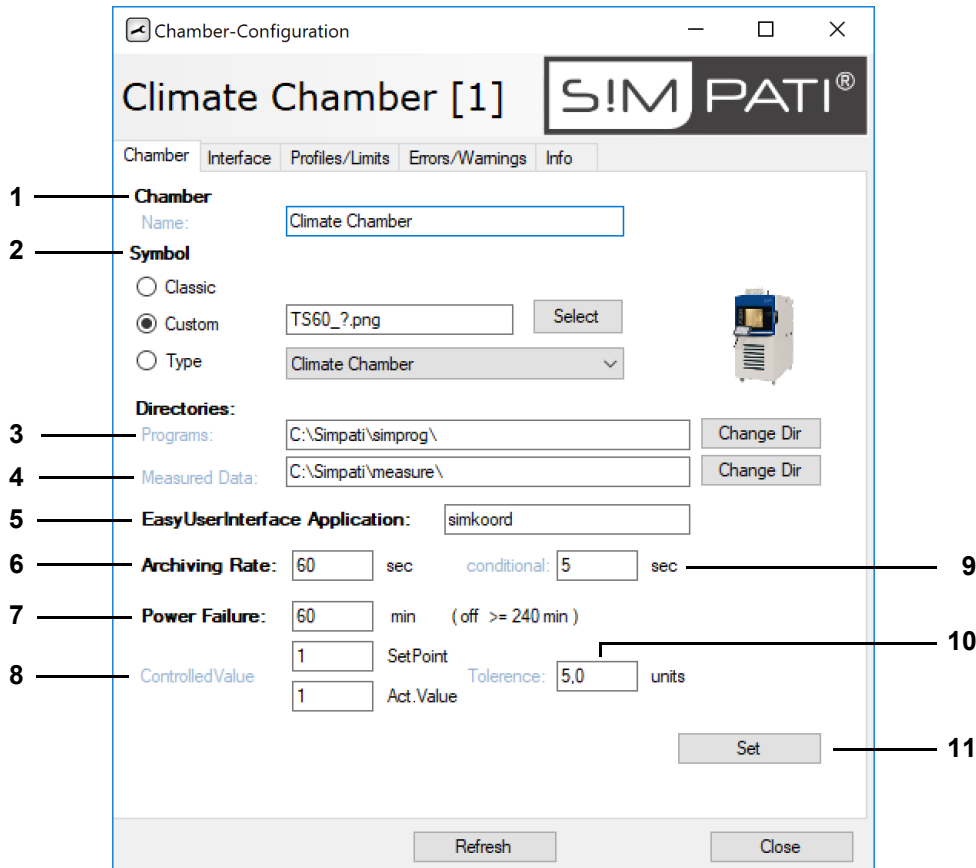

Fig. 6-1: General chamber configuration

- 1 Test system name shown on the main screen.
- 2 Test system icon shown on the main screen.
You can choose from a standard icon, a user-defined icon or the icon of the test system type concerned.
- 3 Test programs directory.
- 4 Measured data directory.
- 5 Define the customer application. A customer application is a program module you will run frequently either from the context menu of the test systems or by double-clicking on the test system icon on the main screen, e.g. *SimStatus.exe*, *SimKoord.exe* or *SimViewer.exe*.
→ 5.1.3 »Context menu for test systems« (page 53), “Customer application”
- 6 Time between two entries during recording.
The default data capturing cycle of the archiving module is 5 seconds. The archiving interval can only be integer multiples of 5 seconds, the only exception being the “rapid archiving” option which supports archiving intervals shorter than 5 seconds.
- 7 Tolerated maximum power failure time. Entering 240 minutes will accept any power failure time.

Testing will be continued if the control variable (item 8) is within the tolerance range and provided that the power failure does not last longer than the set time. To continue archiving, you need to restart the computer.

- 8 ID of the control variable whose actual value must stay within the tolerance range (item 10) to continue testing after a power failure. The value is preset and cannot be changed.
→ 6.3 »Setting profiles/limits« (page 81)
- 9 Time between entries if the default version is used for data capture after a power failure, i.e. 5 seconds or an integer multiple of 5 seconds.
- 10 Tolerance range of the control variable (item 8) a value must stay within to continue measuring after a power failure.
- 11 Save settings.

Test system-to-SIMPATI® interface configuration

6.2 Test system-to-SIMPATI® interface configuration

Use the context menu of the test systems to access this menu.

→ 5.1.3 »Context menu for test systems« (page 53), “configuration”.

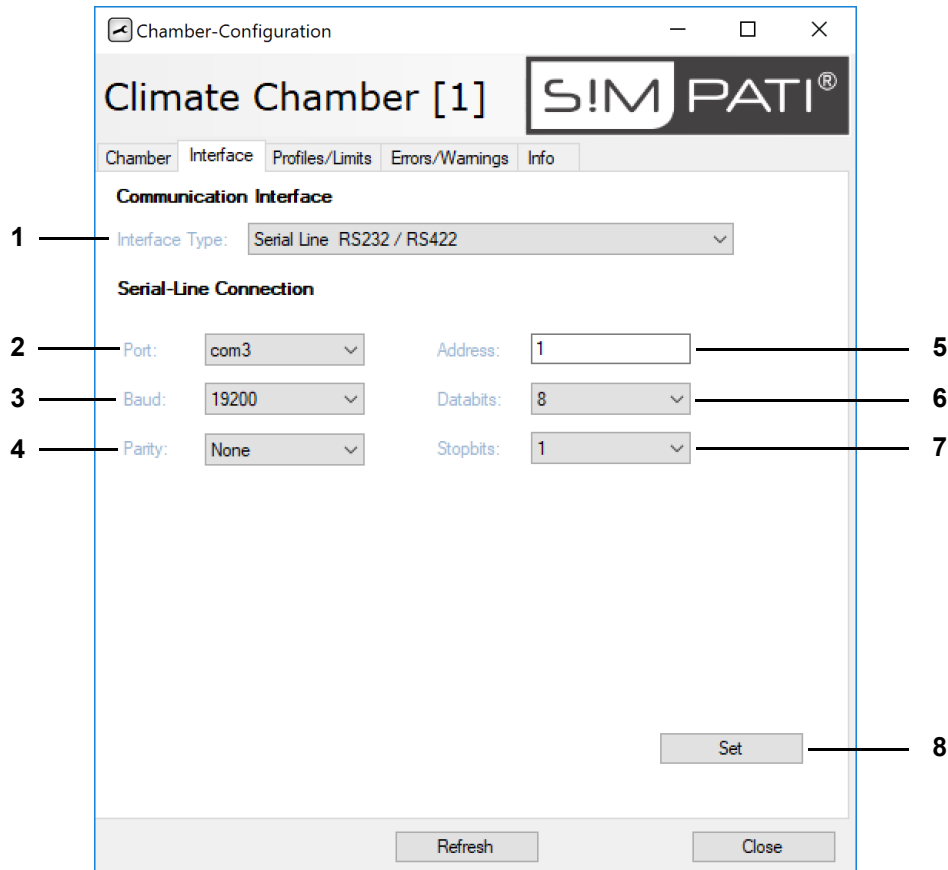

Fig. 6-2: Chamber configuration: interface

- 1 Type of interface used for data interchange between the PC and the test system.
- 2 PC port.
- 3 Transfer rate.
- 4 Parity.
- 5 Test system address.
- 6 Data bits.
- 7 Stop bits.
- 8 Save settings.

6.3 Setting profiles/limits

Use the context menu of the test systems to access this menu.

→ 5.1.3 »Context menu for test systems« (page 53), “configuration”.



The pharma variant does not allow you to enter any values. Use the status menu to enter values nevertheless.

→ 7 »Manual mode and chamber status« (page 85)

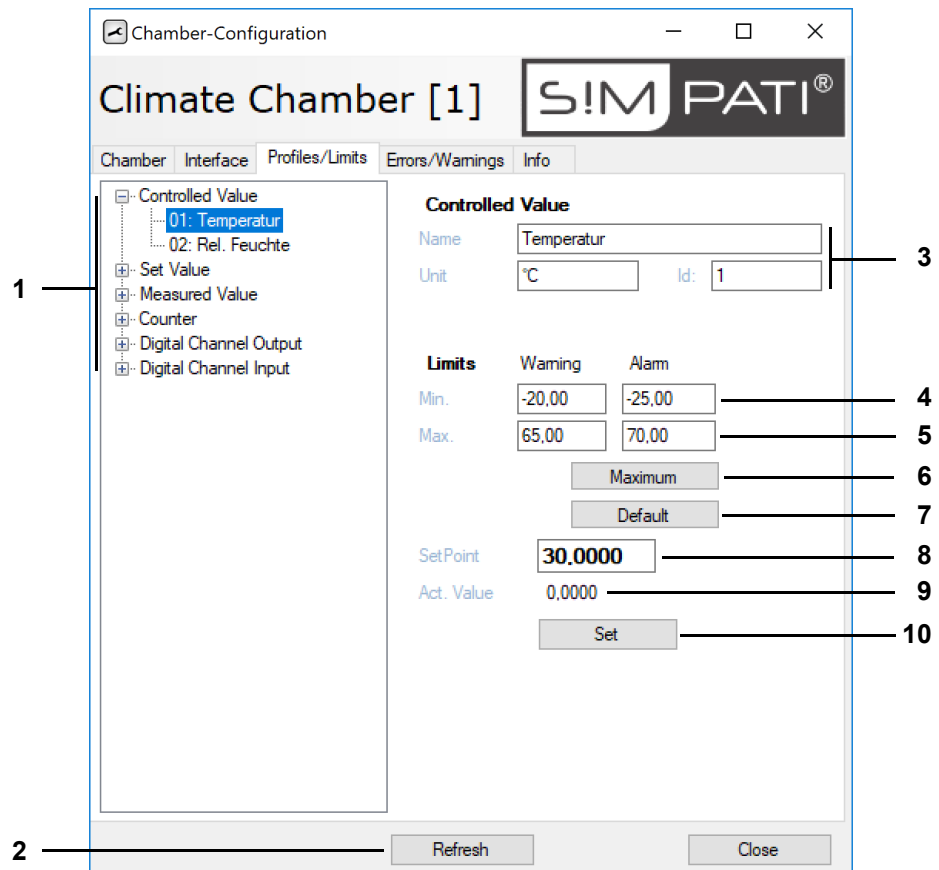

Fig. 6-3: Chamber configuration: profiles/limits

- 1 List of parameters for controlling the test system and for data capture.
- 2 Update the view.
- 3 Designation, unit and ID of the parameter selected.
- 4 Lower warning and alarm limit.
- 5 Upper warning and alarm limit.
- 6 Maximum warning and alarm limit values of the test system.
- 7 Standard test system values for warning and alarm limits.
- 8 Nominal value (for manual operation).
- 9 Actual value.
- 10 Save settings.

Showing errors/warnings

6.4 Showing errors/warnings

Use the context menu of the test systems to access this menu.

→ 5.1.3 »Context menu for test systems« (page 53), "configuration".

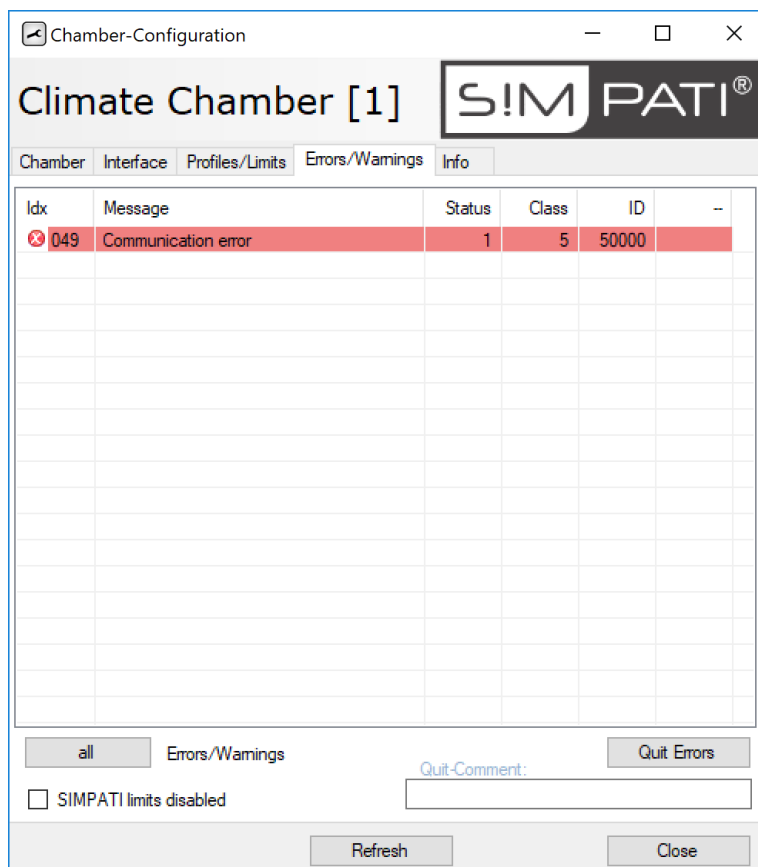

Fig. 6-4: Chamber configuration: errors/warnings

You can tick "SIMPATI® limits disabled" only if you have the right to "Change alarms/warnings".

The tab is described in the section below:

→ 15.1 »Showing the list of warning/alarm/error messages« (page 193)

6.5 Showing chamber details

Use the context menu of the test systems to access this menu.

→ 5.1.3 »Context menu for test systems« (page 53), “configuration”.

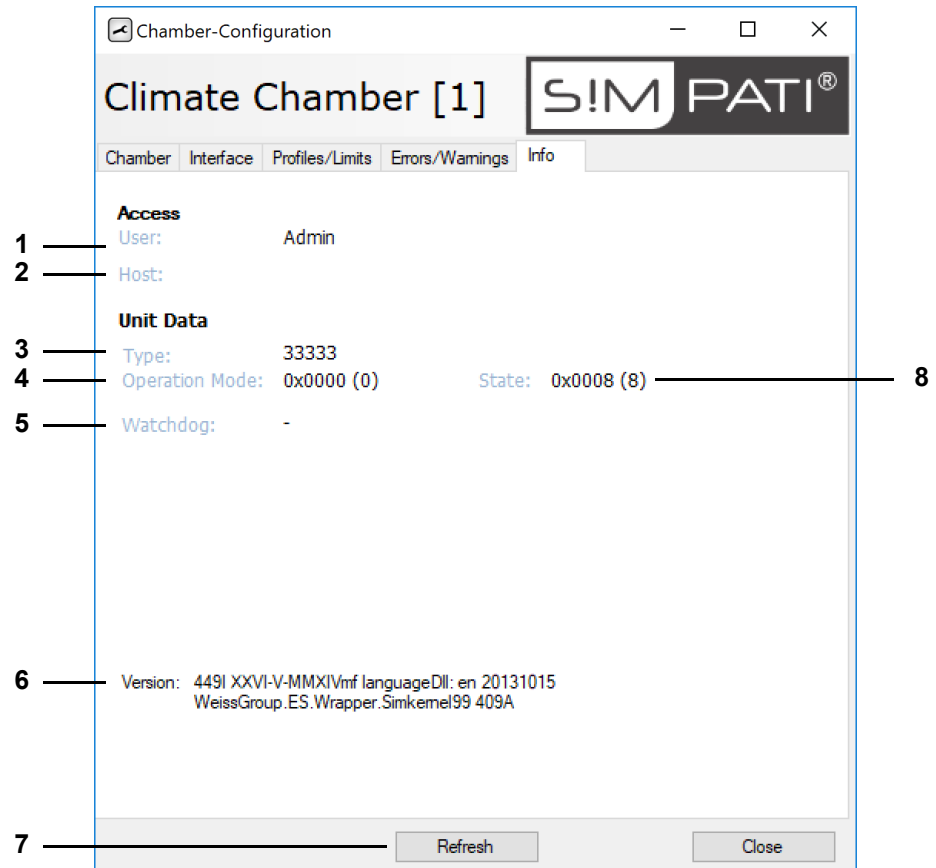

Fig. 6-5: Chamber configuration: Info

- 1 Currently logged-in user.
- 2 Server/PC controlling the test system.
- 3 Info for service personnel.
- 4 Info for service personnel.
- 5 Info for service personnel.
- 6 SIMPATI® version no. / active SIMPATI® language.
- 7 Update the view.
- 8 Info for service personnel.

[Showing chamber details](#)

7 MANUAL MODE AND CHAMBER STATUS

Use the context menu of the chamber to access this menu.

→ 5.1.3 »Context menu for test systems« (page 53), "Status".

The menu screen displays the actual chamber status and is used to operate the system in manual mode.

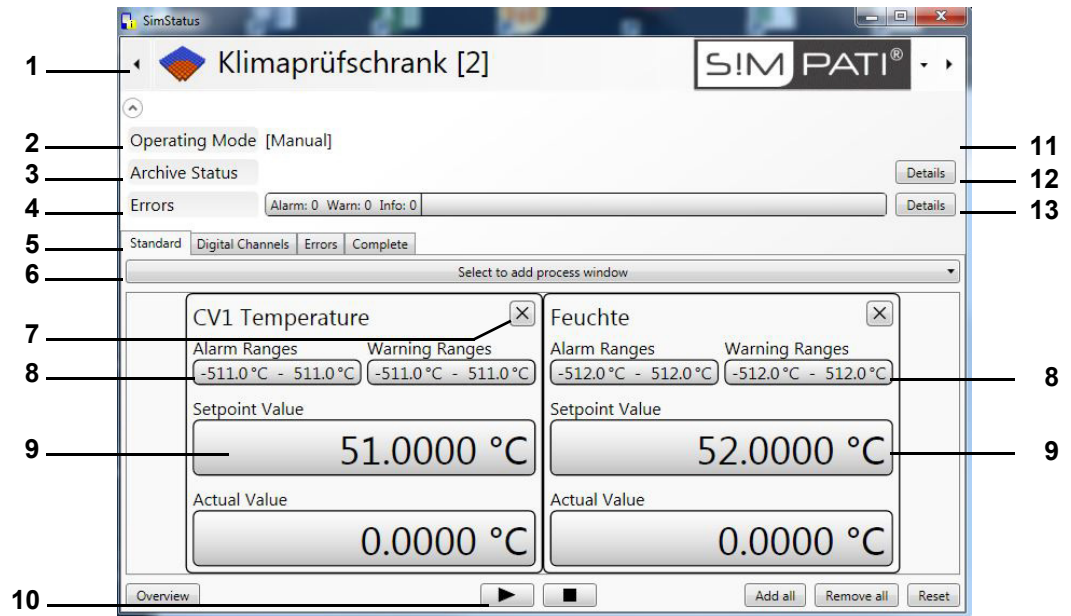

Fig. 7-1: Chamber status indication

- 1 Select chamber.
- 2 Operating mode.
- 3 Archiving.
- 4 Display warning/alarm/error messages.
- 5 Choice of display types.
- 6 Select the process data to be displayed.
- 7 Close the window.
- 8 Text boxes for entering warning and alarm limits.
- 9 Text boxes for entering nominal values.
- 10 Start and stop test in manual mode.
- 11 In automatic / program mode you can access a menu window containing information about the test program (page 88).
- 12 If the test is to be recorded, a menu window with archiving information will be available (page 89).
- 13 Opens the list of warning / alarm / error messages, see Fig. → 15.1 »Showing the list of warning/ alarm/error messages« (page 193).

Tests in manual mode

7.1 Tests in manual mode

The following window appears when clicking on one of the fields marked with "9":

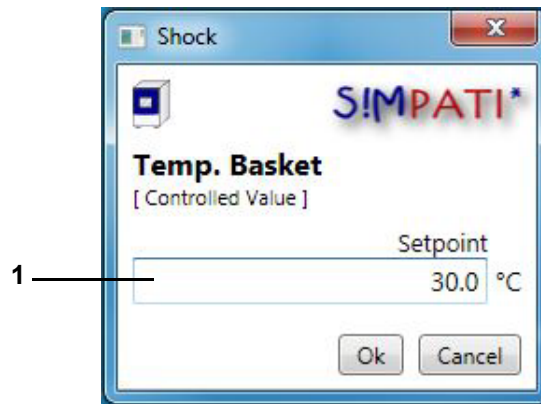

Fig. 7-2: Input menu – nominal value

1 Enter value and confirm with "OK"

The pharma variant displays the Enter Password box.

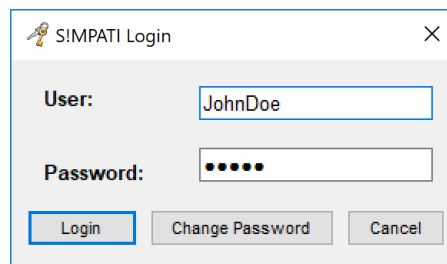

Fig. 7-3: SIMPATI® login

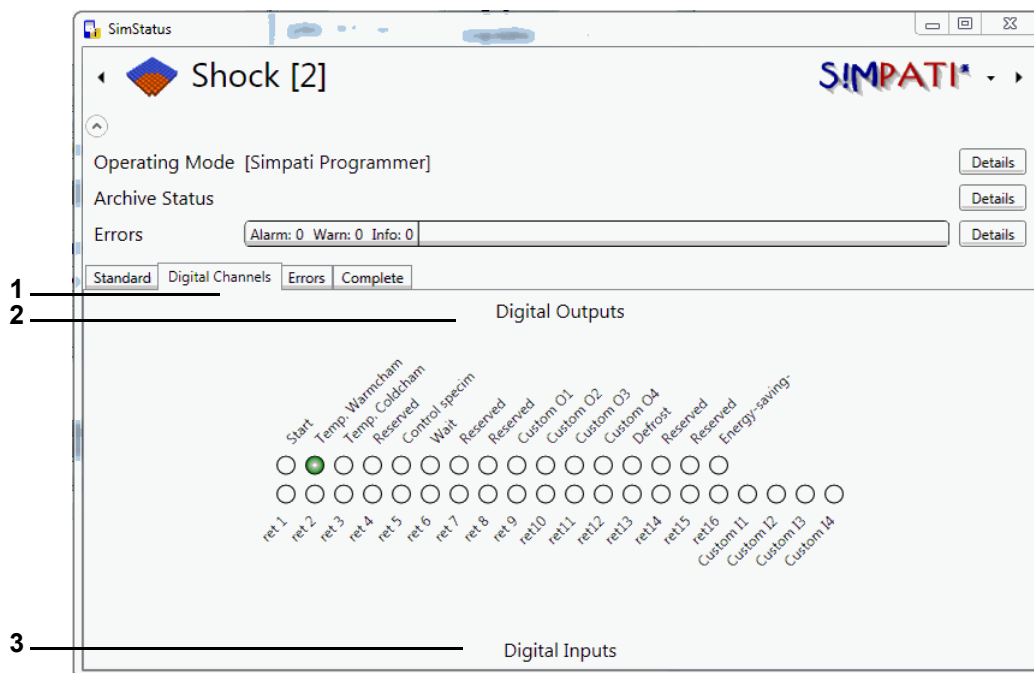

Fig. 7-4: "Digital channels" tab

Active channels are highlighted green. The channels are activated or deactivated by clicking on the respective checkbox.

You start the system by clicking on the Start checkbox. The pharma variant displays the Enter Password box.

- 1 "Digital channels" tab
- 2 Digital outputs.
- 3 Digital inputs.

Chamber status screen

7.2 Chamber status screen

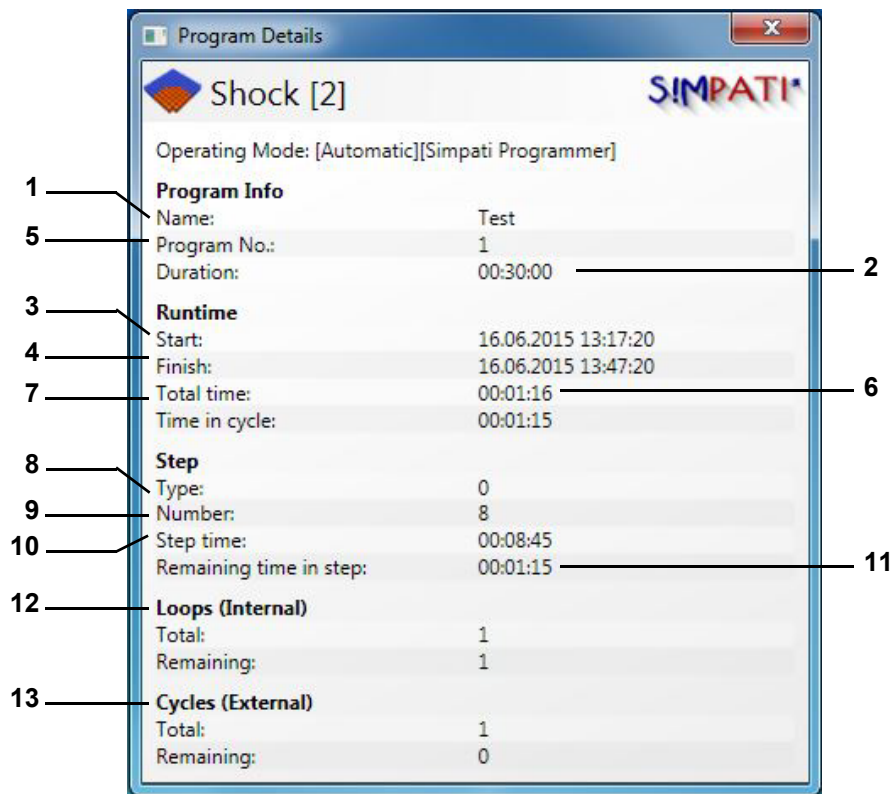

Fig. 7-5: Automatic/program mode details screen

- 1 Test program name.
- 2 Total runtime of test program.
- 3 Start time of test program.
- 4 End time of test program.
- 5 Test program number in the chamber controller.
- 6 Elapsed runtime.
- 7 Runtime of current cycle.
- 8 Program step type.
- 9 Current program step (CTC controller).
- 10 Runtime of current step.
- 11 Remaining runtime of current step.
- 12 Program loops.
- 13 Complete program repeats (as selected at the start of the program).

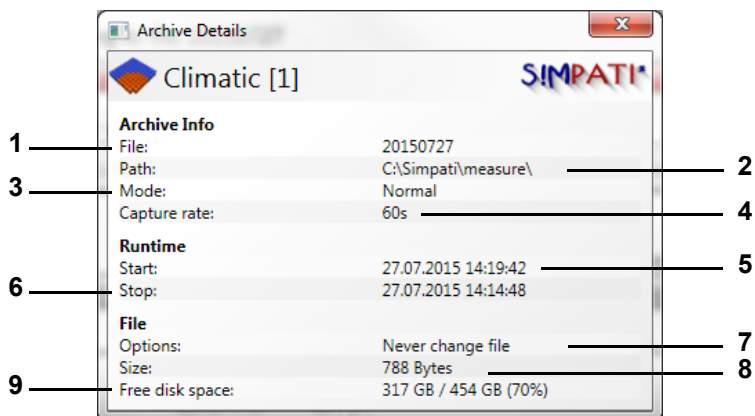

Fig. 7-6: Window with archiving information in automatic/program mode

- 1 Archive name.
- 2 The measurement file is stored in this directory.
- 3 Data capture mode.
- 4 Data is captured in the archiving cycle defined for malfunction events.
→ Fig. 11-1: »Archiving« (page 155)
- 5 Start of data capture.
- 6 End of data capture (here: same as end of test program).
- 7 Options such as daily name change.
- 8 Size of archive file.
- 9 Free hard drive memory.

Chamber status screen

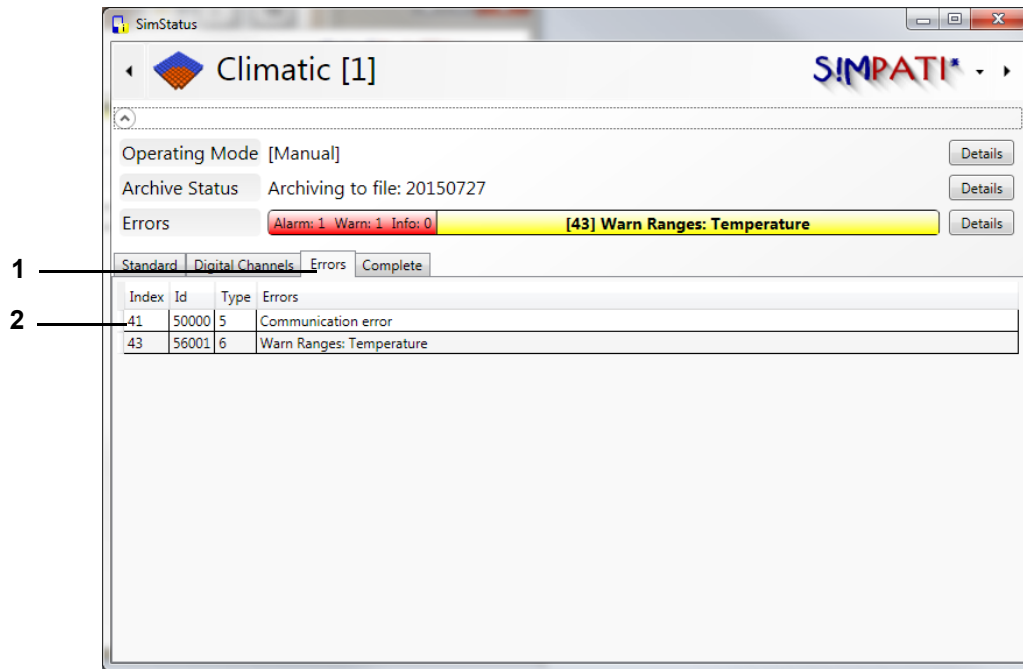

Fig. 7-7: "Errors" tab

- 1 "Errors" tab.
- 2 List of the error messages shown in the columns:
 - Index: error index generated by SIMPATI
 - ID: error identification number.
 - Type: error type.
 - 1 controller error
 - 2 controller warning
 - 4 info
 - 5 SIMPATI error
 - 6 SIMPATI warning
 - Error: error description.

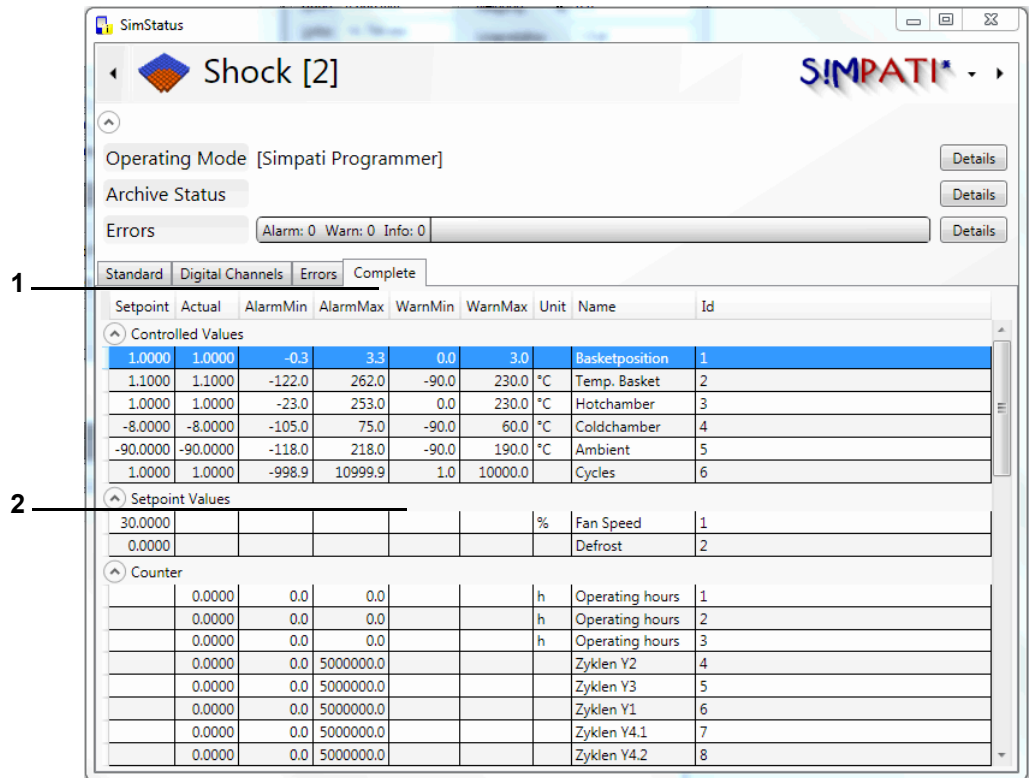

Fig. 7-8: "Complete" tab

- 1 "Complete" tab.
- 2 List of available variables including their values, limits, units and IDs.

Chamber status screen

8 CREATING A TEST PROGRAM

Use the context menu of the chamber to access this menu.

→ 5.1.3 »Context menu for test systems« (page 53), "program editor".

When programming loops, please take the following information into account → »Loop« (page 124).



Test programs in the Graphic Editor are automatically saved in the Symbol Editor format also. This function is also available in the Symbol Editor. Select the appropriate settings when saving.

► Check your test programs after such an import or export.

8.1 General notes on creating programs

8.1.1 Guaranteed holding time

At larger temperature changes, it will take some time until the temperature is as it should be. The programmed test duration (holding time) is kept at the temperature required using this function. This means that SIMPATI® detects when the temperature required is reached and only then the programmed holding time begins. During that time, the temperature will not change until the holding time is over.

If a jump is programmed, the jump time is automatically adjusted to include the time required to match the actual value to the nominal value required.

Guaranteed holding time when programming ramps:



- When programming a ramp, deactivate the guaranteed holding time for the time the ramp is due.
- At the end of the ramp, you may enter a guaranteed holding time again.

Only the following controllers support the guaranteed holding time function: DMR, Prodicon Plus, Mincon, Simcon, Simpac and Stange. The method of programming depends on the controller as described below.

... for chambers with a DMR controller

After setting up the test program as normal, the following also needs to be considered as regards this controller.

Guaranteed holding time is activated via digital channel 8.

Program a tolerance band to allow SIMPATI® to detect when the nominal temperature is reached. Then with the right mouse button click on a profile data point on the temperature curve. Now use the context menu function to set the tolerance band.

Please note that the tolerance band must be revised after a jump.



Tolerance band monitoring is only available for the temperature profile in the standard version (»R2-38«).

- If monitoring of temperature and humidity is required, the 32 bit configuration must be set on-site by the service personnel.

Using the symbol editor to create test programs

... for chambers with a Prodicon Plus or Stange controller

After setting up the test program as normal, consider the following as regards this controller:

Guaranteed holding time is activated via digital channel 17. Digital channel 17 is not configured by default and must be adapted if required using the Service Hotline.

Program an envelope curve to allow SIMPATI® to detect when the nominal temperature is reached. Envelope curves work similar to a tolerance band. Then with the right mouse button click on a profile data point on the temperature curve. Now use the context menu function to set the envelope curve.

As opposed to tolerance bands, envelope curves need not be manually adapted to other controllers if a jump is included.

... for chambers with Mincon, Simcon, Simpac, MOPS, CTC or TC controllers

After setting up the test program as normal, the following also needs to be considered as regards one of these controllers.

Program a tolerance band to allow SIMPATI® to detect when the nominal temperature is reached. Then with the right mouse button click on a profile data point on the temperature curve. Now use the context menu function to set the tolerance band.

Use the Wait function as an alternative to the tolerance band.

The Wait function can also be programmed in the symbolic editor in the Mincon, Simcon and Simpac controllers → »Wait function« (page 101).

8.2 Using the symbol editor to create test programs

Use the context menu of the chamber to access this menu. (»symbolic«)

The symbol editor is a programming tool for chambers controlled by a Simcon, Simpac or Mincon controller. Test programs can be saved in the symbol editor format. This allows you to run the test programs created at this point in chambers equipped with other controllers.

Profiles that are not displayed will appear as inactive on the control panel and will not be taken into account by the program sequence, i.e. these profiles are kept at the value set.



- ▶ Make sure that all of the profiles required for operation of the chamber are correctly entered and displayed.
-

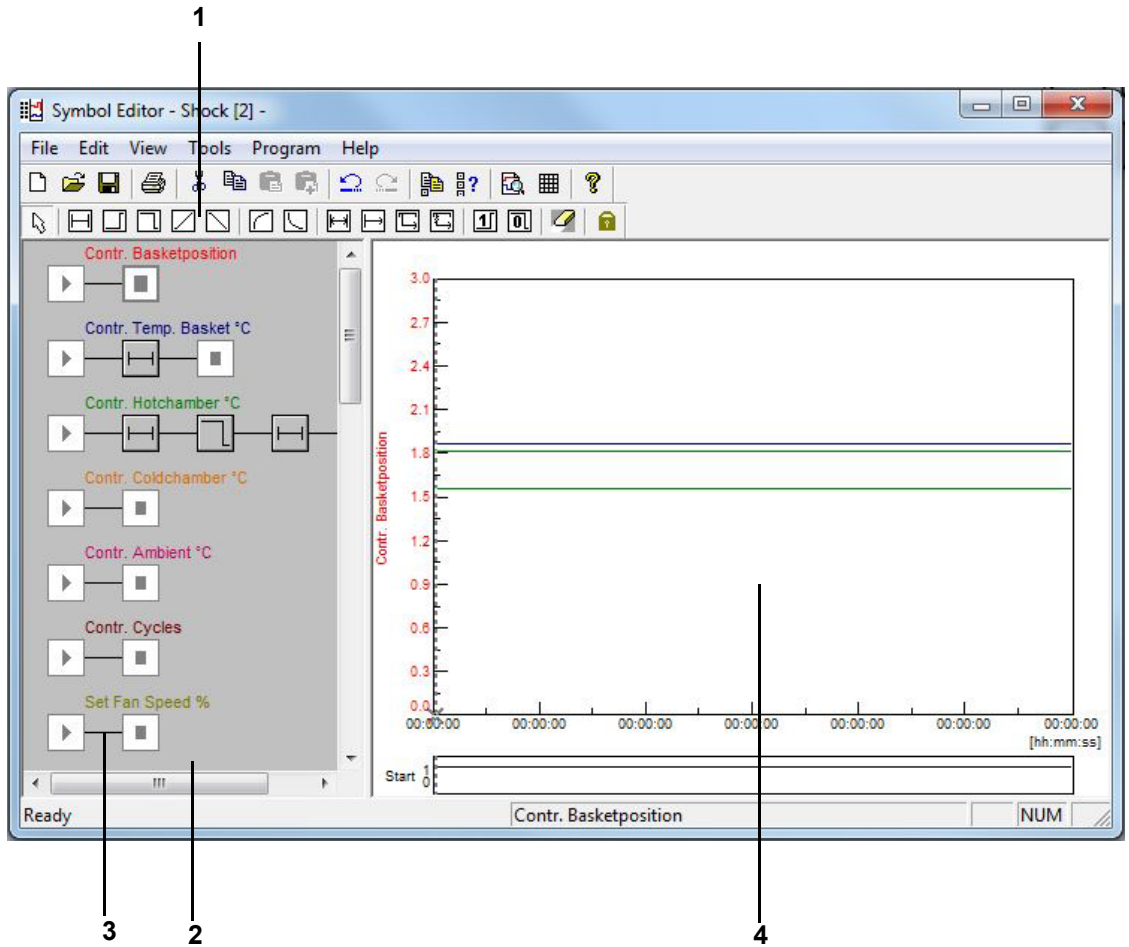



Fig. 8-1: Symbol editor







- 1 Program blocks.
- 2 Profile.
- 3 Link line.
- 4 Preview.

Programming involves program blocks picked from the icon bar and joined to make up a profile. A profile depicts the test sequence (preview) of the corresponding control variable, digital channel or control value.









Program block	Explanation
	Selection function. → »Selection block« (page 100)
	Timer block for all profiles. → »Time block« (page 100)

Using the symbol editor to create test programs

8.2.1 Analog function for control variables and control values

Program block	Explanation
	Nominal value jump up. → »Nominal value jump up/down« (page 100)
	Nominal value jump down. → »Nominal value jump up/down« (page 100)
	Nominal value ramp up. → »Nominal value ramp up/down« (page 102)
	Nominal value ramp down. → »Nominal value ramp up/down« (page 102)
	E-function up. → »E-function« (page 103)
	E-function down. → »E-function« (page 103)

8.2.2 Functions affecting the program sequence

Program block	Explanation
	Loop. → »Loop« (page 104)
	Conditional program jump. → »Conditional program jump« (page 104)
	Start of program by other test program. → »Call for a different test program (sub-program)« (page 105)
	Stop of another running program. → »Program stop for a different test program (sub-program)« (page 105)
	Digital channel IN. → »Digital channel ON/OFF« (page 106)
	Digital channel OUT. → »Digital channel ON/OFF« (page 106)
	Eraser block for deleting program blocks. → »Eraser function« (page 106)
	Lockout function to maintain the current selection. → »Lockout function« (page 106)

After left-clicking to select a program block, the mouse pointer takes the shape of the program block you selected. Left-click on a link line to drop the program block at that place. Clicking on an existing program block allows you to replace that block. Dropping the program block or double-clicking on a dropped program block automatically displays dialog for programming the block.

8.2.3 Configuring a profile



Select profile

Use the context menu of the start block to select the profiles to be displayed and to define their start values.

► Description → »Select Profile« (page 107)

Profile Settings

You get the → »Profile Settings« (page 97) menu for entering the appropriate start values via the context menu or by double-clicking on the start block.

Start value

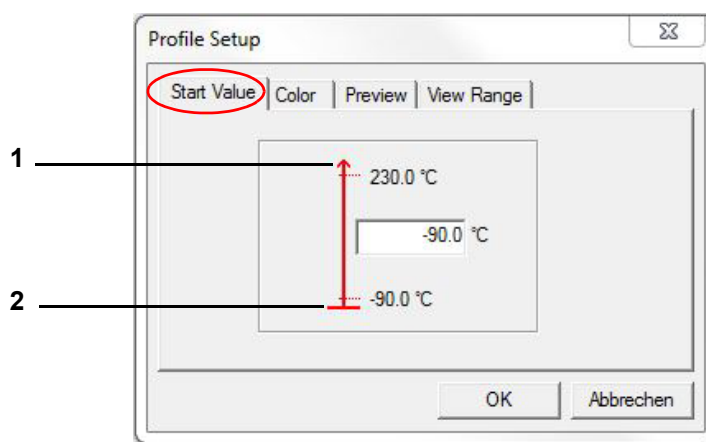

Fig. 8-2: Start value

- 1 Upper chamber limit.
- 2 Lower chamber limit.

Used to set the start value of a profile (within chamber limits). Please note that the chamber needs an appropriate amount of time to set this value. Take this time into account during programming.



The start value for all control variables, control values and digital channels is preset with the minimum value (within the range of the chamber limit) by default. If a particular start value is to apply to every program to be created in the same system, then it has to be set in Select profile as the standard (description under item D).

Using the symbol editor to create test programs

Colours

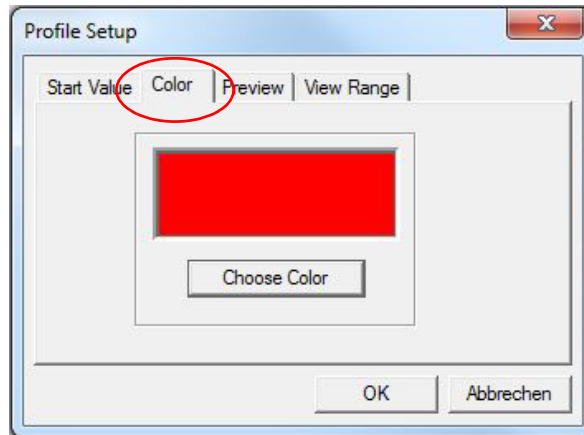

Fig. 8-3: Colour

When creating a new test program, the default colour settings of the configuration will be assigned to the profile. The colour settings can be individually adapted and saved as the default settings → »Select Profile« (page 107).

8.2.4 Test

Preview

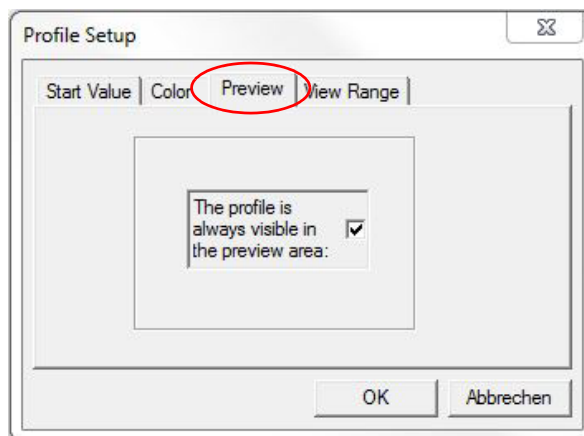

Fig. 8-4: Preview

The preview of the symbol editor will always show the profile you selected. When enabled, this function will accept this channel into the preview and add to the current profile. To reduce the unsteadiness when building up the preview, you are recommended to just show as many profile as necessary for programming.

Viewing range

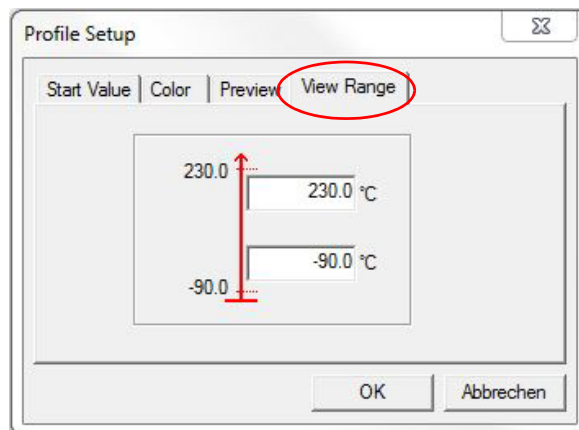

Fig. 8-5: Viewing range

Within the time axis, the preview automatically adjusts to the nominal values. This screen lets you adjust the Y axis to your personal preferences by entering a value between -100,000 to +100,000.

Using the symbol editor to create test programs

8.2.5 Working with program blocks

Placing or double-clicking on the program block displays the associated configuration screen. A preview will be displayed only if data has been stored for the program block.



Selection block

The only way to activate a program block in a profile is with the selection symbol. After each programming operation, the program block used is automatically no longer active and the selection block becomes available again. If this needs to be disabled, use the → »Lockout function« (page 106).

By pressing the Ctrl key, several blocks can be selected by clicking or using a rubber band line.



Time block

The constant block defines how long the previously set value should be held (shown as a level in the preview). Use this function for control variables, control values and digital channels.

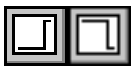

Nominal value jump up/down

A jump allows you to increase or decrease a nominal value as quickly as possible. Use this function for control variables and control values.

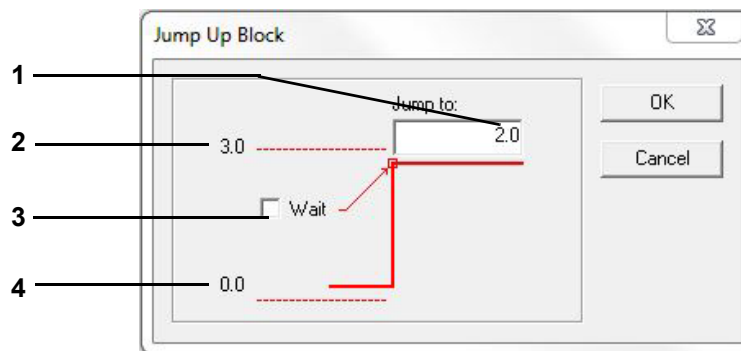

Fig. 8-6: Nominal value jump

- 1 Enter jump target (nominal value).
- 2 Maximum jump target (channel limit).
- 3 Enable Wait function at the jump target.
- 4 Current nominal value before the jump.

You can enable the Wait function when reaching the jump target. The Wait function causes the program runtime to be paused until the actual value is located within the Wait range defined.

Enabling the Wait function opens a dialog for entering the values.

The example is for a jump up. If there is a jump down, the current value is at Item 2 and the value of the chamber lower limit is at Item 4.

Wait function

The upper and lower Wait value is transferred to the configuration dialog.

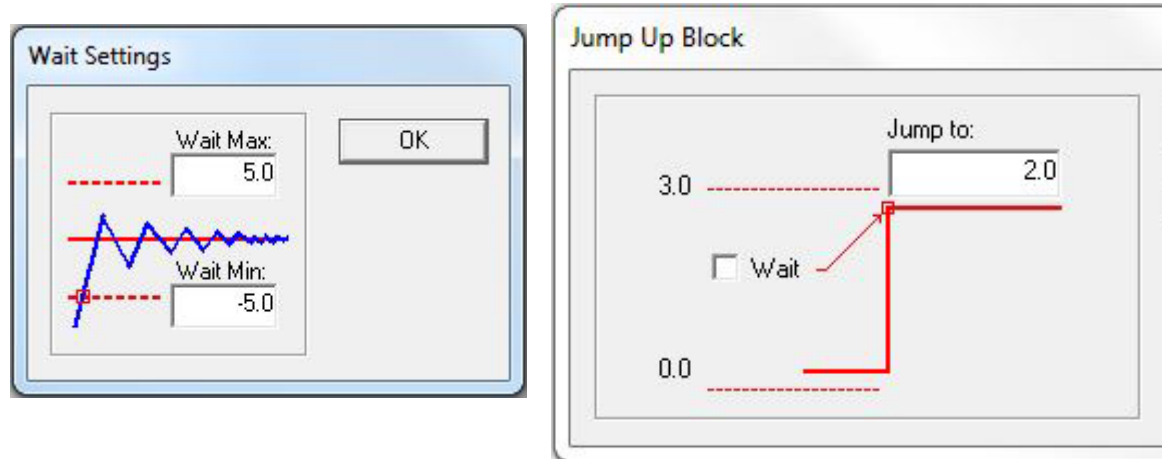
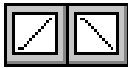

Fig. 8-7: Wait function

Programming a nominal value jump down is carried out in a similar manner.

Using the symbol editor to create test programs



Nominal value ramp up/down

A ramp is a guided increase or decrease of a nominal value. Use this function for control variables and control values.

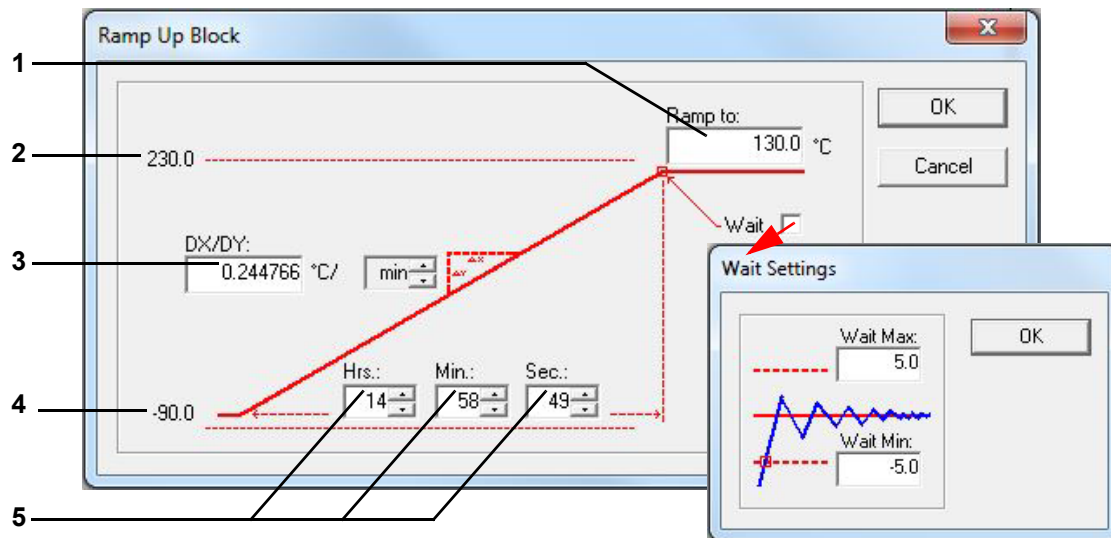

Fig. 8-8: Nominal value ramp

- 1 Enter the ramp target (nominal value).
- 2 Maximum ramp target (chamber limit).
- 3 Speed of ramp change.
- 4 Current nominal value before the ramp.
- 5 Ramp time.

The example is for an upward ramp. If the ramp is down, the current value is at Item 2 (page 102) and the value of the lower chamber limit is at Item 4 (page 102).



E-function

Fig. 8-9: E-function

- 1 Current value.
- 2 Time needed for 1τ
- 3 Lower chamber limit.
- 4 Applicable τ range, 1τ to 5τ
- 5 Applicable τ range, 1τ to 5τ
- 6 E-function target.
- 7 Difference between initial and target values.

The example is for a downward E-function slope. If the E-function is rising, the current value is at Item 3 (page 103) and the chamber upper limit value is at Item 1 (page 103).

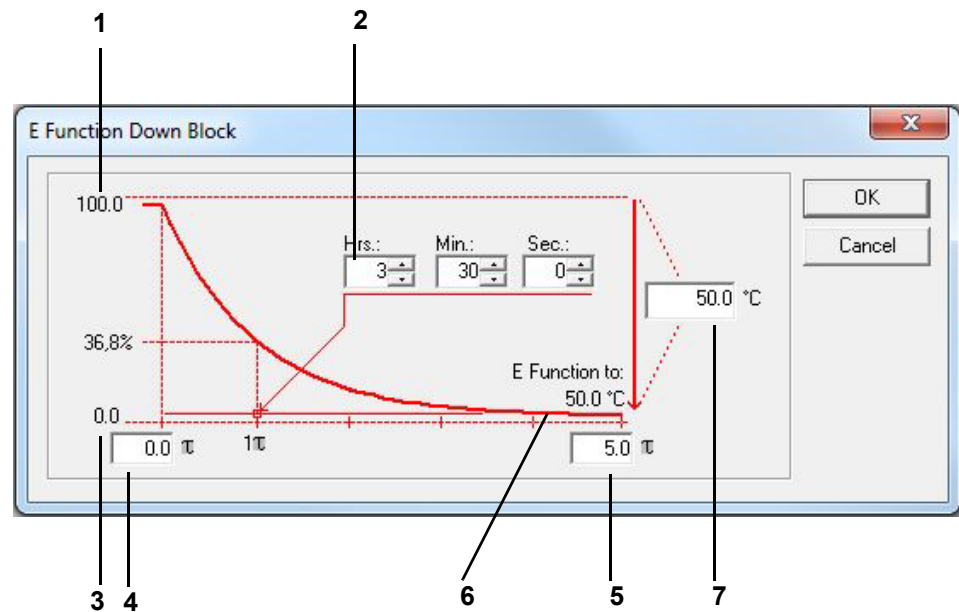
Using the symbol editor to create test programs



Loop

Use this program block to define a loop that will repeat a part of the program. The procedure is to select the loop block and define two distinct positions at either end of the section to be repeated. A program block also has to be included in the program section to be repeated; this block must explicitly indicate a time. Jumps and ramps, for example, are processed in time »X« and therefore are unsuitable.

First paste a program block for the loop start and for the loop end. Then the menu where you can enter the loop repeat factor appears.



Conditional program jump

This function is available only with Flash version 00.17 or higher (Mincon / Simcon controller).

Depending on the state of the digital channel, you can use this function to make the program go to another point in the program to continue from there. Like with loops, first of all select the jump block, then define two distinct positions:

Block that causes the program to determine the status of the corresponding digital channel.



Block that defines the destination to which the program should jump when the appropriate conditions have been met.



The jump is made if the state of the digital channel is the same as the one defined at this point.



Call for a different test program (sub-program)

This function is available only with Flash version 00.17 or higher (Mincon / Simcon controller).

Use this function at the test program runtime to start and run another test program as a sub-program of the main program. As a precondition this test program was first transferred to a program slot in the chamber controller.

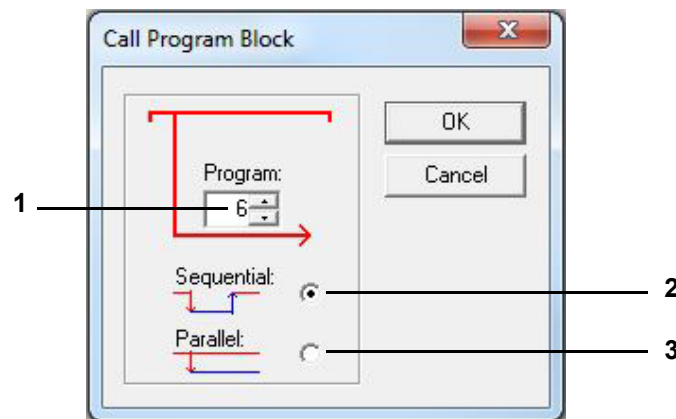

Fig. 8-10: Example: Sub-program

- 1 Number of sub-program.
- 2 If the sub-program is called in sequence, the current test program is exited, the sub-program is processed and after which the test program that made the call continues to be processed.
- 3 If the sub-program is to run in parallel, it runs at the same time as the main program. Make sure that only those profiles from the sub-program are processed for which the preview is active.
→ »Preview« (page 98)



When test programs are to be executed in parallel, take into account that like profiles cannot be processed at the same time.



Program stop for a different test program (sub-program)

This function is available only with Flash version 00.17 or higher.

Use it to stop a sub-program running in parallel.

Using the symbol editor to create test programs



Digital channel ON/OFF

These functions are used to switch a digital channel on or off.



Eraser function

This function enables a program block to be deleted from a profile.

Select the eraser symbol and double-click on the block that is not required. Answer the security prompt to actually delete the icon. Another method is to use the keyboard or the tasks menu to delete the selected block.



Lockout function

After each programming operation, the program block used is automatically no longer active and the selection block becomes available again. If this needs to be disabled in order to use the active program block several times in succession, select the lockout function. It remains active until you toggle it off again.

The »Undo/Redo« function (»Undo/Redo«)

You can undo / redo at most the last 19 steps.

8.2.6 The »File« menu function

Open

Use this item to run a test program created in the symbol editor (*.bxx) or the graphic editor (*.pxx). Select the appropriate file type.

Save / Save As

This function is used to save the test program with its own name or with a new test program name. The test program can be saved in the format of the graphical editor (*.pxx) or in the format of the symbolic editor (*.bxx). Set the file type accordingly. Use only letters, numbers and the understroke key for the test program name.

Since the functions of the graphic and the symbol editor are not exactly the same, you must review and manually modify the test program in the graphic editor. This may lead to some loss in the import file.

Print / Page view

Depending on the display, the program list or the preview is printed as it appears in the print preview (»Print Preview«).

Printer setup

Used to set the printer properties. The printer properties can be separately selected and saved for the program list and for the preview.

List / Comment

Shows a code list of the test program. Any comment you enter appears at the top of the list. This function does not let you modify the test program.

8.2.7 »Edit« menu function

Select Profile



Via the menu and the context menu of the start block, you can select the control variables, digital channels or control values for which a profile is to be displayed and processed in the menu window.

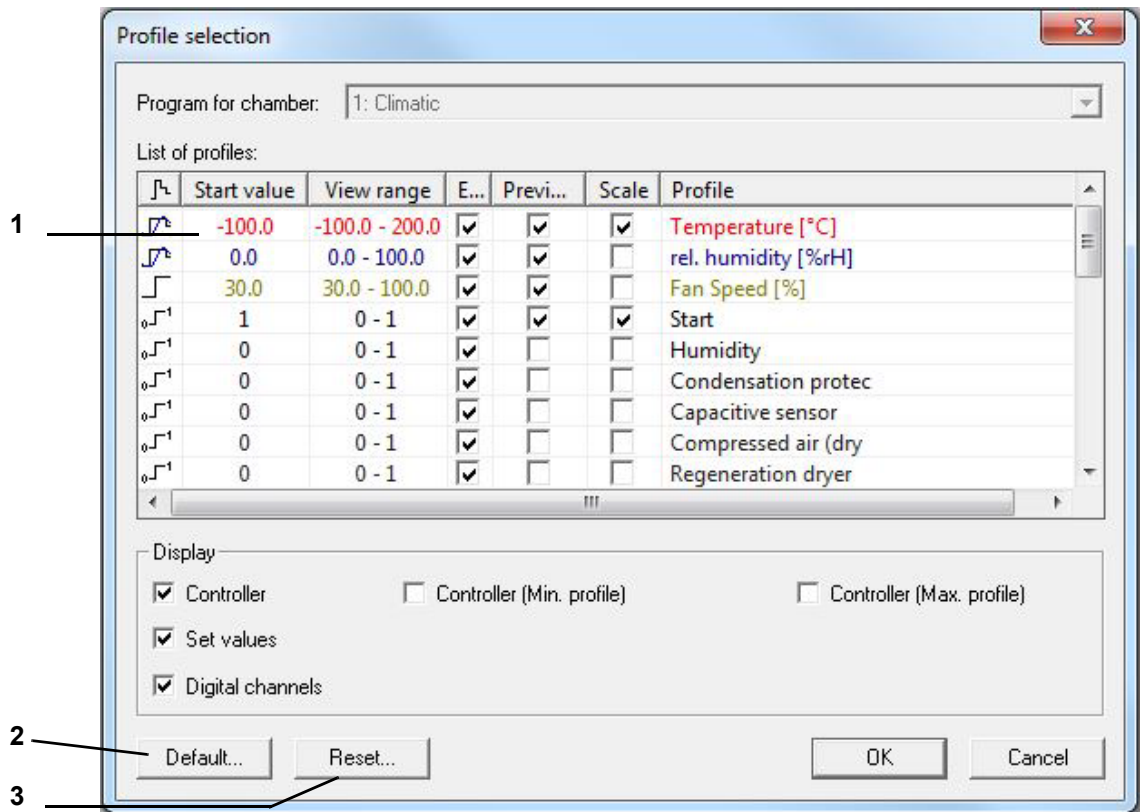

Fig. 8-11: Profile selection

- 1 Double-click to show the *profile settings*.
This setting is only valid for this test program.
- 2 The settings are specified for each new test program.
- 3 Resets all settings.

Using the symbol editor to create test programs



Copying profiles

This function is used to save the test program under another file name, for the current chamber or another chamber. If the test program is to be saved for a different chamber, define here which profile characteristics of the current chamber are to be assigned to the control variables, digital channels or control values of the destination chamber.

- ▶ To do this, activate the display for all control variables, digital channels and control values for the current chamber.
- ▶ Check the profiles which are to be copied, otherwise the profile will not be copied. The original profile and the corresponding destination profile must be side-by-side in the same row.
- ▶ Place the mouse pointer in the Destination chamber column in the row with the control variables, digital channels or control values that are to be newly assigned. Right-click in this row. You receive the complete selection of all control variables, control values and digital channels for the destination chamber.
- ▶ From this list, select which control variable, digital channel or control value should correspond to the profile in the left of this row.

Wrongly assigned profiles may provoke malfunctions. You may find that customer outputs are used differently or that a chamber provides options, for example.



Profiles which are not selected will appear as inactive on the control unit and will not be taken into account by the chamber controller.

- ▶ Make sure that all of the profiles required for operation of the chamber are entered correctly.

Inactive values in Simpac controllers:



When changing from climatic to temperature mode the value for the humidity has to be manually set to zero % because otherwise the previous humidity value is retained.

Example:

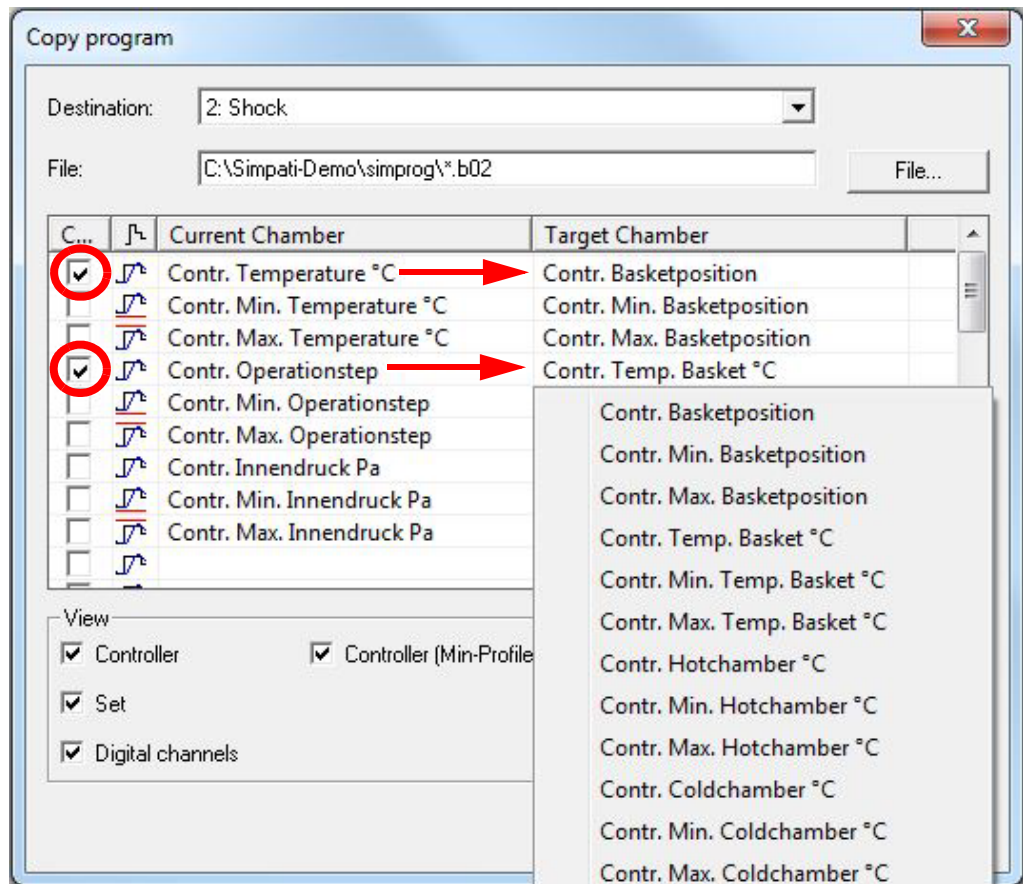

Fig. 8-12: Copy program

The control variable »TempLift« now accepts all the settings of the control variable »Temp. Lifting Basket«.

The control variable »Hot Temp« is assigned all the settings of the control variable »Hot Chamber«.

Apart from the control variables, you can specify profiles for the upper and lower warning limit (min profile and max profile). These profiles are needed whenever the set tolerance is not symmetrical to the nominal value, e.g. when cooling down IEC 68230.

Copying preview

Copies a bitmap image of the preview to the clipboard.

Synchronising

A loop or jump added to a profile (reference profile) has to be considered in all other profiles. This is best achieved by also adding the loop or jump to the other profiles.

The → »Synchronising« (page 109) function adapts all profiles to the loop / jump settings of the reference profile according to the default settings in the »Loops and Jumps« menu if this is not already activated and synchronisation was carried out automatically.

Using the symbol editor to create test programs

Cut/Copy/Paste

Program blocks can be moved, copied and pasted into any profile. The settings will be copied along with the program block. Settings transferred to another profile may have to be modified (synchronised).

By pressing the Ctrl key you can select multiple blocks; alternatively, you can select them with the aid of a rubber band line in order to copy, move or delete them.

8.2.8 »View« menu function

Icon bar	File	Shows / hides the bar with the function icons.
	Program	Shows / hides the bar with the programming icons.
Status bar		Shows / hides the bar underneath the symbol editor. The bar shows details explaining the current function.
	Split Lock	If enabled, the function stops you from changing the size of the programming panel or the preview by moving the horizontal scrollbar to the left or right using the mouse or your finger.

8.2.9 »Extras« menu function

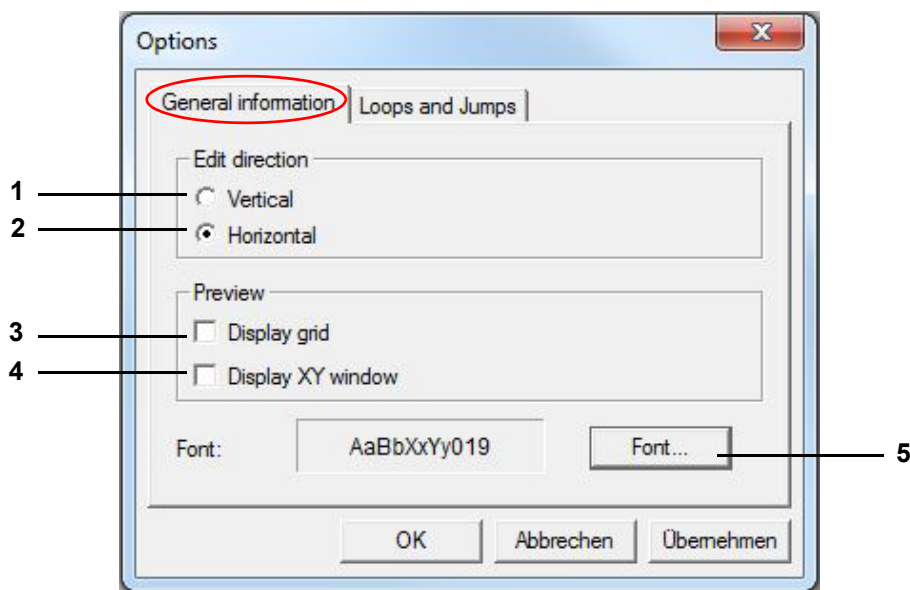

Fig. 8-13: Extras

- 1 Align the display vertically
- 2 Align the display horizontally
- 3 Show grid lines
- 4 Show XY display
- 5 Change font for the profiles, the preview and the program list

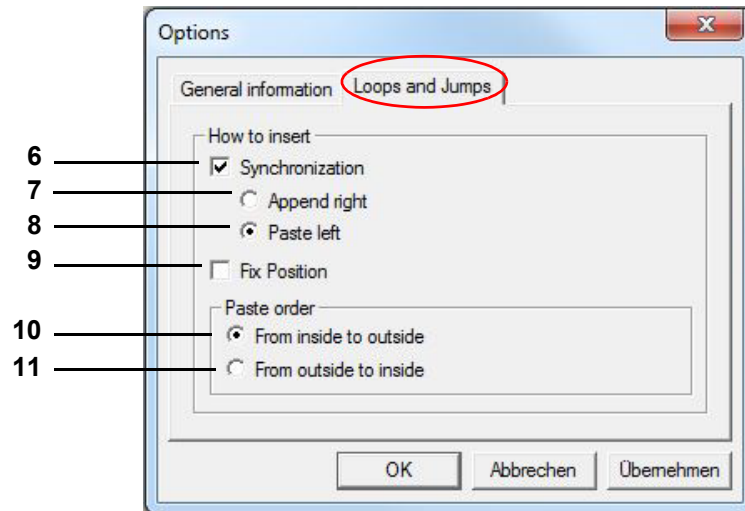

Fig. 8-14: Loops and jumps

6 Synchronising



If the synchronisation function is activated, the remaining profiles are automatically adapted after placing a loop / jump in a profile.

We recommend that the status of the Synchronisation function should not be switched between "active" and "inactive" during programming.

When pasting a loop / jump into the rest of the profiles, all the program blocks including time allowances are incorporated. Here you have to define whether the loop start should be pasted to the left or to the right of the program blocks without a time allowance.

7 The start / end is pasted to the right of the last program block without a time allowance.

8 The start / end is pasted to the left of the first program block without a time allowance.

Time blocks reflecting the progress over time of the reference profile are added to profiles not containing program blocks with time settings.

9 The loop / jump is constant in terms of time, i.e. the time of the program section cannot be extended in the loop / jump. Everything that goes beyond the original length is moved outside the loop. If this is not desired, deactivate this function and/or reset the loop.

Pasting order

The paste order of the program blocks for the loops / jumps must be observed if several loops / jumps are pasted into a profile; this prevents the start and end of different loops / jumps from overlapping.

10 Program blocks for the loops / jumps can only be placed from the inside to the outside; subsequent pasting of a loop / jump into an existing loop / jump is not possible when this function is active.

11 Program blocks for the loops / jumps can only be placed from the outside to the inside; subsequent pasting of a loop / jump around an existing loop / jump is not possible when this function is active.

8.2.10 »Program« menu function

Alternative to the icon bar for selecting program blocks.

Using the graphic editor to create test programs

8.3 Using the graphic editor to create test programs

Use the context menu of the chamber to access this menu.

→ 5.1.3 »Context menu for test systems« (page 53)



The pharma variant does not include this editor.

→ Appendix: »Installation for operation in pharmaceutical environments« (page 243)

The graphic editor shows a graphic image of the test program you are creating or modifying.

1 New → Fig. 8-16: »New profile« (page 113)

2 Open

Open a test program imported from the symbolic editor. Check the profile sequence in the graphical editor. The functions of the graphical and symbolic editors, for example, do not entirely coincide; the import may be lossy as a result.

3 Preview

Graphic program preview

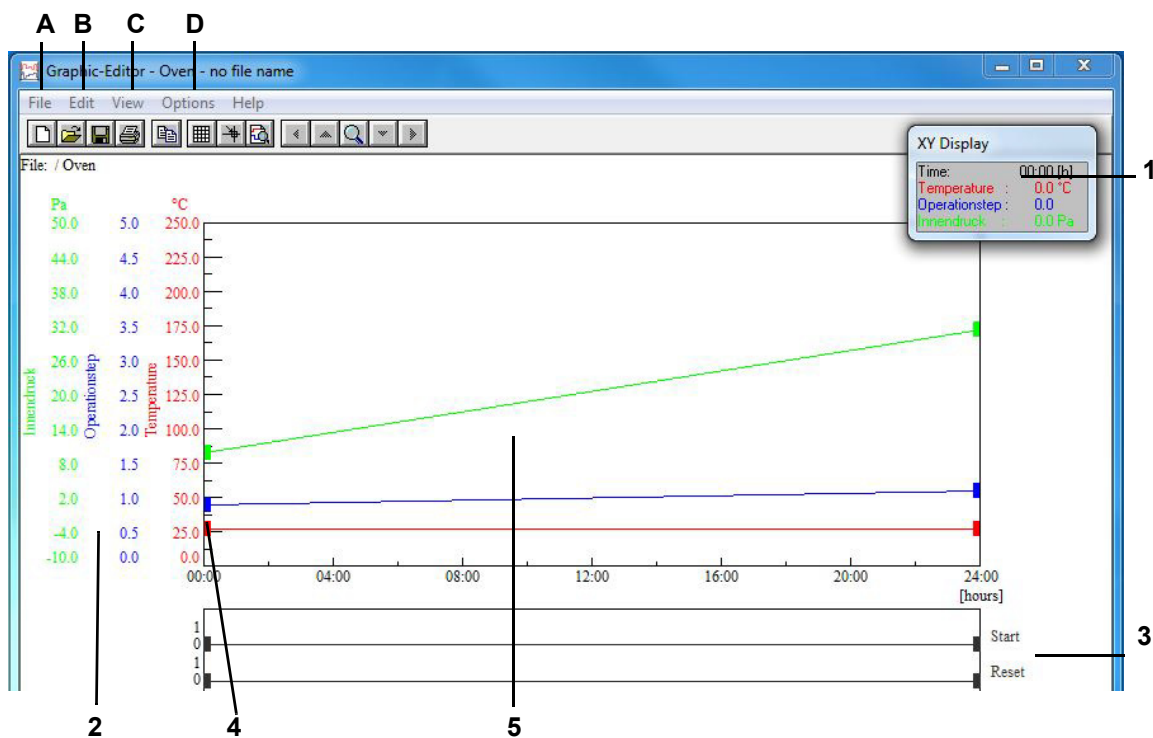

Fig. 8-15: Program preview

- 1 Moveable XY display
- 2 Scale for control variables
- 3 Scale for digital channels
- 4 Profile data points
- 5 Working panel

Double-click on the graph to set or remove profile data points. To move a profile data point, click on it, then drag it to another place.

8.3.1 »File« menu item

New

This function is used to create a new test program.

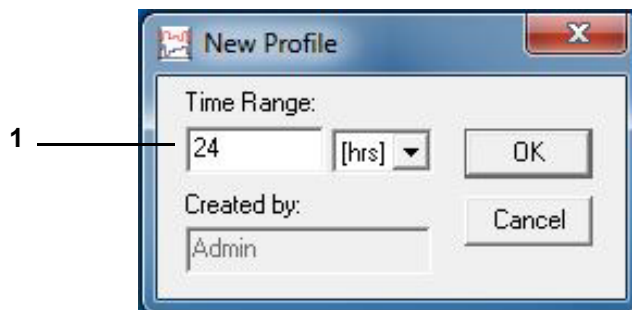

Fig. 8-16: New profile

1 Enter the test program duration; this can be changed.

Open

A menu window for opening a test program appears.

Save

File name

→ *Appendix: »Glossary and tips« (page 261)*, → *»Test program name / Program number« (page 262)*

Save As

Use this function to copy a test program and save it under a different name.

Delete

Used to delete test programs.

Using the graphic editor to create test programs

Copy program

Used to copy the current test program to another chamber. The test program you copy will be given another name. You cannot copy profiles to existing test programs.

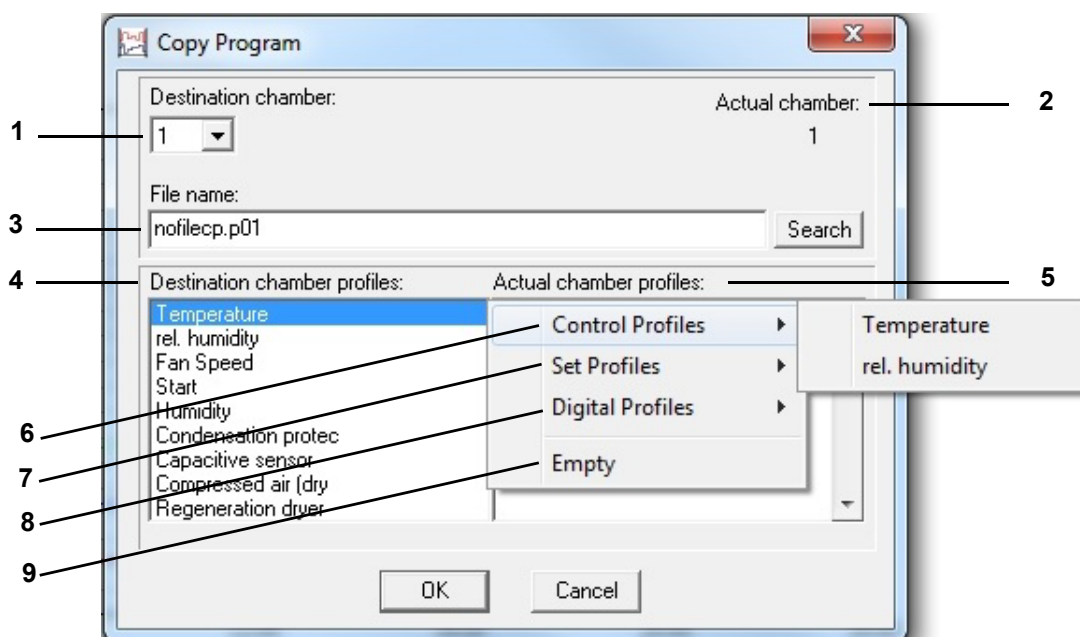

Fig. 8-17: Copying test programs

- 1 Available chambers, select number of the destination chamber
- 2 Number of the current chamber whose test program is to be copied
- 3 Upon selecting the destination chamber the directory for storage is specified automatically. The file name is the same as for the current chamber with »cp« (copy) appended. The extension is the number of the destination chamber.
- 4 Channels available in the destination chamber (Item 1). These channels need to be assigned to the profiles.
- 5 Profiles of the current chamber (Item 2)
- 6 Control variables of the current chamber
- 7 Control values of the current chamber
- 8 Digital channels of the current chamber
- 9 Empty item

Profile assignment:

- ▶ Select a channel of the target chamber
- ▶ Double-click on the black bar in the list box Item 5
- ▶ Select the profile with a single click



If the range of a control variable of the current chamber is larger than that of the destination chamber, the profile is automatically adapted to the limits of the destination chamber.

8.3.2 »Edit« menu function

Copy

Use this function to copy a bitmap image of the current view to the clipboard and makes it available for further handling in another application.

8.3.3 »View« menu function

Grid

Used to show gridlines on the working panel.

Show XY values

The XY values are the coordinates of the mouse pointer on the working panel.

Data point calculation

Moving the mouse pointer to a profile data point and left-clicking on it shows the speed of change per minute and the time between this, the previous and the next profile data point.

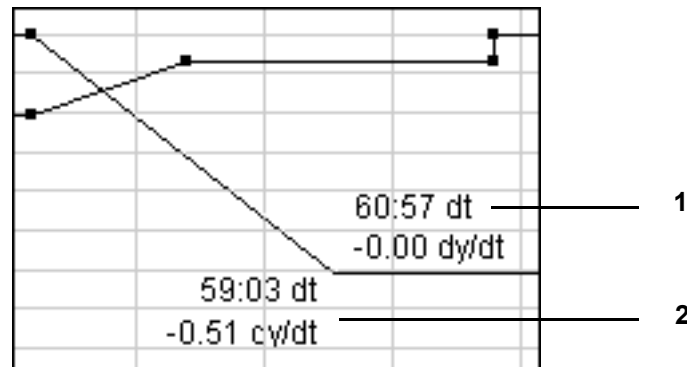

Fig. 8-18: Data point calculation

- 1 Time and speed of temperature change (per minute) with reference to the next profile data point
- 2 Time and speed of temperature change (per minute) with reference to the previous profile data point

Crosshairs

Displays crosshairs. When the function → »Data point calculation« (page 115) is active, the crosshair display can be disabled by pressing the left mouse button.

Using the graphic editor to create test programs

Enlarge XY

Used to select and zoom into an X/Y section. To define the section to be zoomed, single-click at the beginning, move the crosshairs and single-click again at the end.



Move zoomed section

Used to move the zoomed-in section.



Show all

Displays the entire test program.

Time range

This function lets you change the length at the beginning and end of the test program.

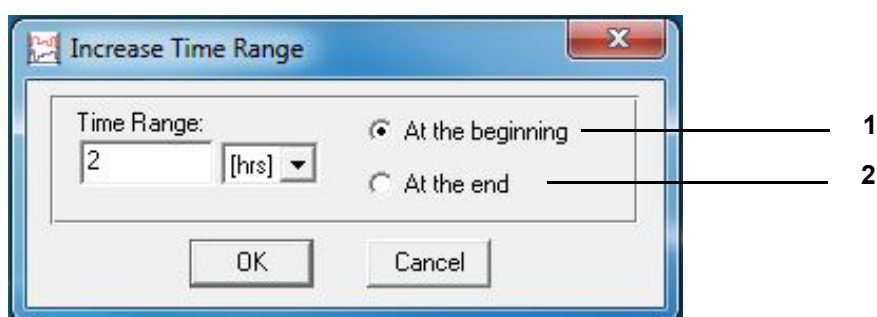

Fig. 8-19: Enlarging time range

1 Lengthens or shortens the beginning of the test program.

2 Lengthens or shortens the end of the test program.

Pasting / deleting time segments within the test profile: context menu command »Revise time«.



Preview

The graph reflects the actual course of the test.

List

Displays the test program as a code list. The program list can be edited via the context menu but you cannot modify the actual test program.

Redraw

Used to refresh the screen. Discrepancies in the hardware and drivers may lead to pixel noise in any drawing program, which can be removed by refreshing the display.

If very many useless pixels are generated, you are recommended to run the driver software of the graphics adapter and disable the graphics accelerator options.

8.3.4 »Options« menu function



Snap function

This function is used to specify a grid so that the profile data points can be located in the snapped positions only.

Entering coordinates without a grid → context menu command → »Value« (page 121).

Profiles

Analog channels (control variables)

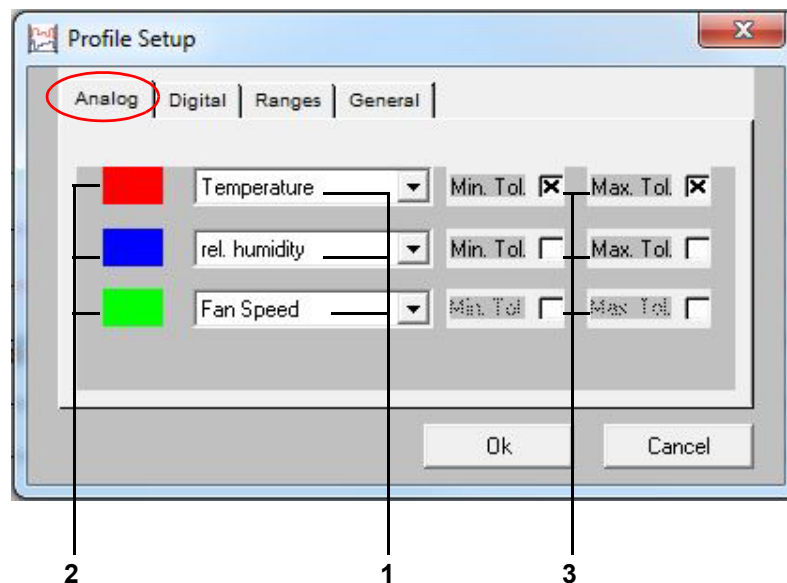

Fig. 8-20: Analog channels

- 1 Select the analog channels that are to be displayed (control variables)
- 2 Colour allocation for the analog channel activated (control variable)
- 3 Select the tolerance band display.

You can select and display up to three analog profiles. A twin display is not supported. Analog profiles not picked for display are retained. Single-click on the coloured box to allocate the colour to the analog channel.

Entering tolerance ranges → context menu command → »Tolerance« (page 122).

Using the graphic editor to create test programs

Digital channels

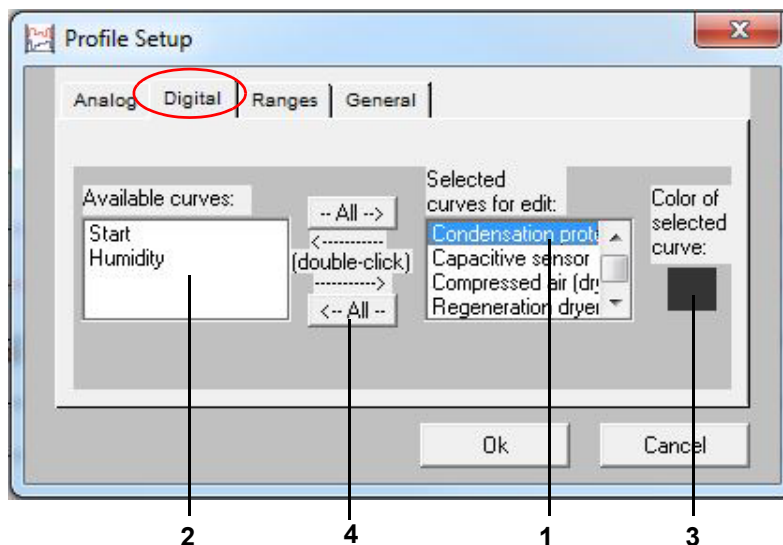

Fig. 8-21: Digital channels

- 1 Select digital channels to be displayed.
- 2 Box listing the available digital channels.
- 3 Colour allocated to the selected digital channel.
- 4 Move all digital channels.

The digital channel display can be activated by double-clicking on the corresponding digital channel in the list box (Item 2). The digital channel appears in the list box (Item 1).

Single-click on the coloured box to allocate the colour to the digital channel.

Working panel

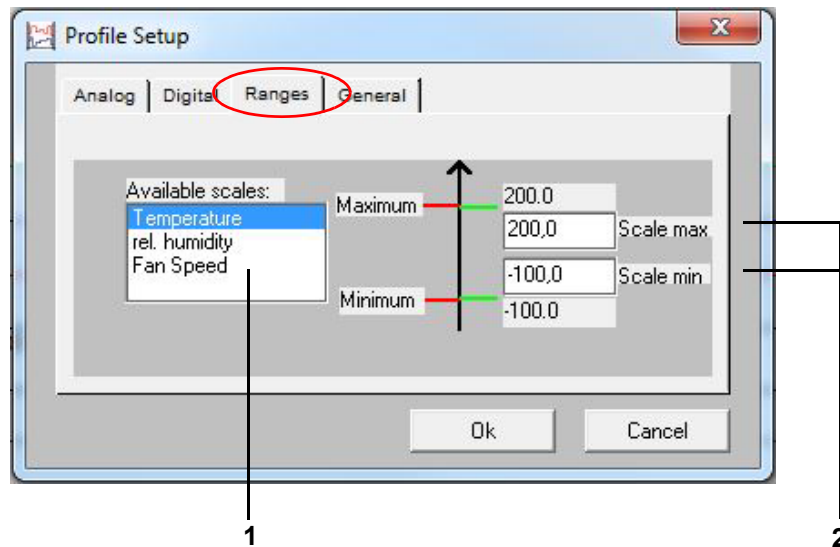

Fig. 8-22: Working panel

- 1 From this box, pick the analog channels (control variables) to be shown as scales.
- 2 Specify the scale range displayed for analog channels (control variables).

Used to set the scale size. Depending on the range setting, existing graphs may be outside the working range specified and therefore cannot be viewed.

Chambers with a Mincon, Simcon, Simpac, MOPS, CTC or TC controller will import these scale limits for use as alarm limits by the controller when the program starts. You can stop this by changing the start file (..\simpati\system\SIMPATI.str) as follows:



- ▶ Include an additional parameter (NOALARMLIMIT) after the entry for the driver.

Old entry: 20 : 01 : simmops::

New entry: 20 : 01 : simmops:\NOALARMLIMIT:

Using the graphic editor to create test programs

General profile settings

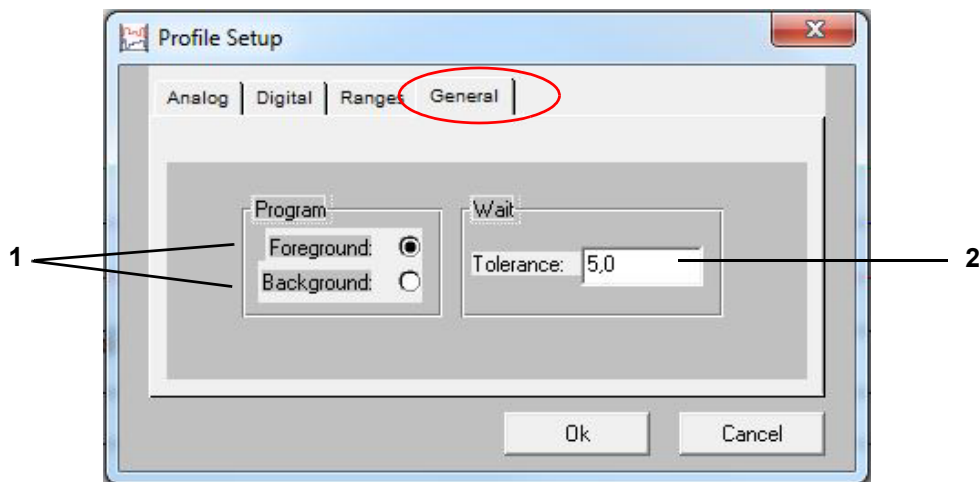

Fig. 8-23: Profile setting

- 1 Foreground / background program.

→ Context menu command **»Wait«** (page 28) and **»Call Program«** (page 28).

- 2 Wait function.

The wait function disallows the test program (and, thus, its time) to progress until the difference between the nominal and actual values equals the value entered in this box. This value applies to all wait functions of this test program. Enter an absolute value.

Grabber settings

Use this dialog to modify the size of the profile data points irrespective of their grabbable range.

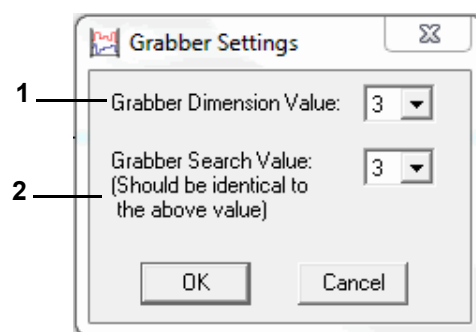

Fig. 8-24: Grabber setting

- 1 Changes the visible size of the profile data points.
- 2 Changes the area around a profile data point that the mouse pointer is able to grab (should be the same as the value above).

File comment

Dialog for entering a comment on the test program. The comment will be saved with the test program.
Line break: Ctrl + enter

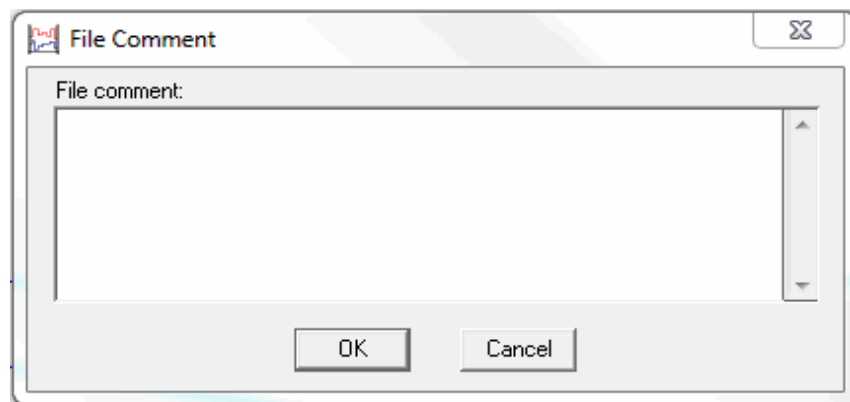

Fig. 8-25: Comment

Comment about any profile data point → context menu command **Comment** (page 27).

Font

The font can be changed for the graphic editor window only.

The font size will scale up and down with the window size.

No other formatting options are available.

A changed font will not be stored with the measurement file. Changing a font makes it the graphic editor font until it is changed again.

Context menu items

Value

Use this item to immediately enter the coordinates of a profile data point.

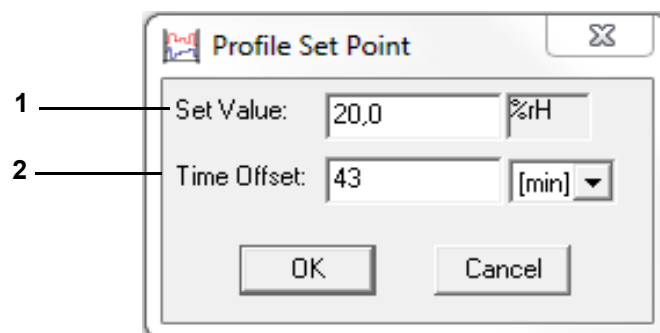

Fig. 8-26: Nominal value

- 1 Position of the profile data point on the scale of the analog channels (control variables).
- 2 Difference in time to the previous profile data point.

Using the graphic editor to create test programs

Tolerance

Enter tolerance band boundaries

The tolerance bands display must be activated → »Analog channels (control variables)« (page 117).

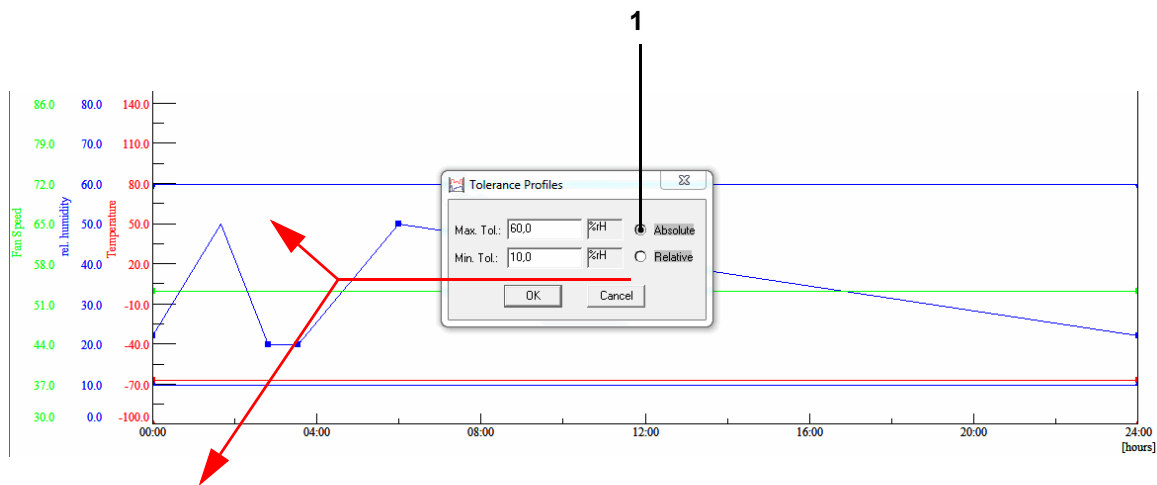

Fig. 8-27: Absolute tolerance band

The tolerance band remains steady at the nominal value specified.

This function is only active with a DMR, Mincon, Simcon or Simpac controller.

The tolerance band is within the specified distance from the nominal value.

Do not enter the minus sign until you have entered the numeral.

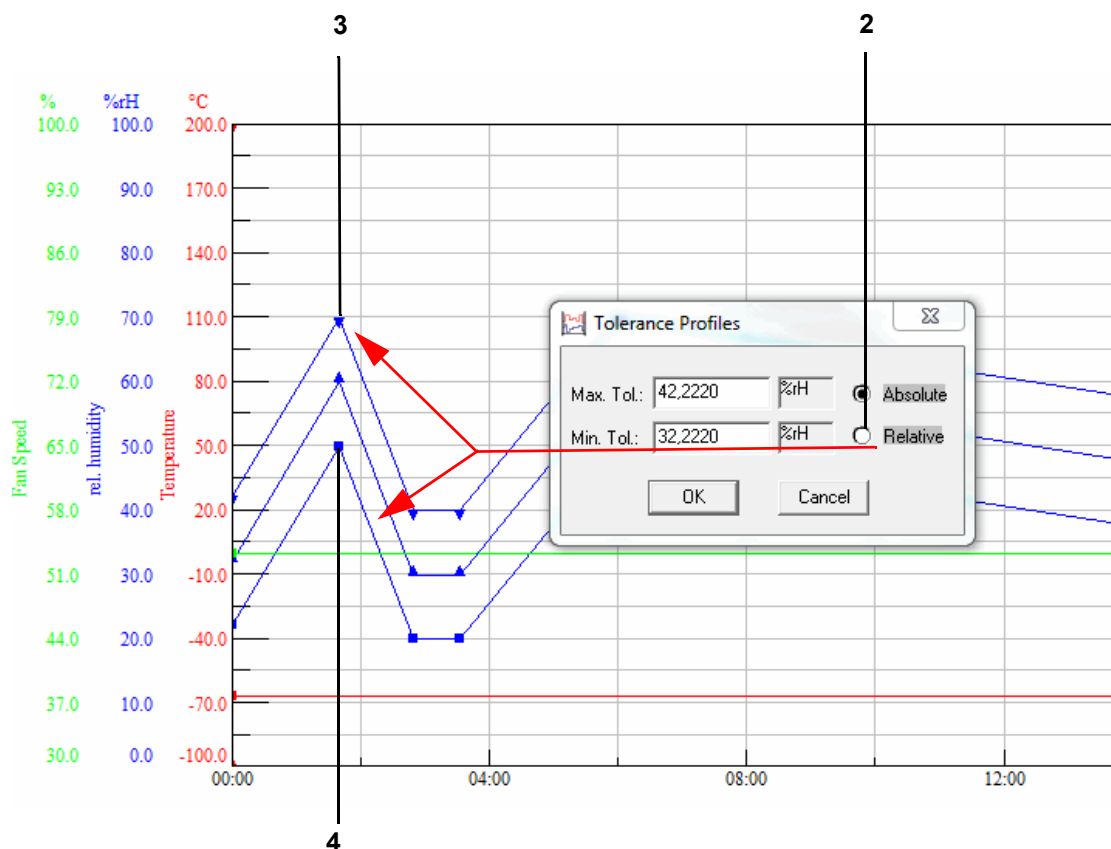
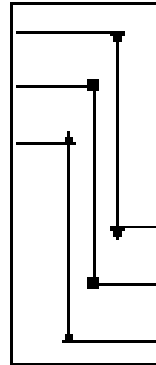

Fig. 8-28: Relative tolerance band

Erstellen eines Programms.fm - en 2020.09 / Version 4.70

The upper (Item 3) and lower (Item 4) tolerance bands have to be distinguished by way of variable profile data points.

A set distance is given for a jump, otherwise lines may cross over and give rise to a controller error message. You will therefore have to manually adapt the tolerance band of jumps.



Comment

You may add a comment to every profile data point.

Using the graphic editor to create test programs

Loop

Use this function to enter a loop. Depending on the specified loop count, all profile data points within this loop repeat when the loop returns to its starting point. You cannot enter a target loop count until setting up the loop.

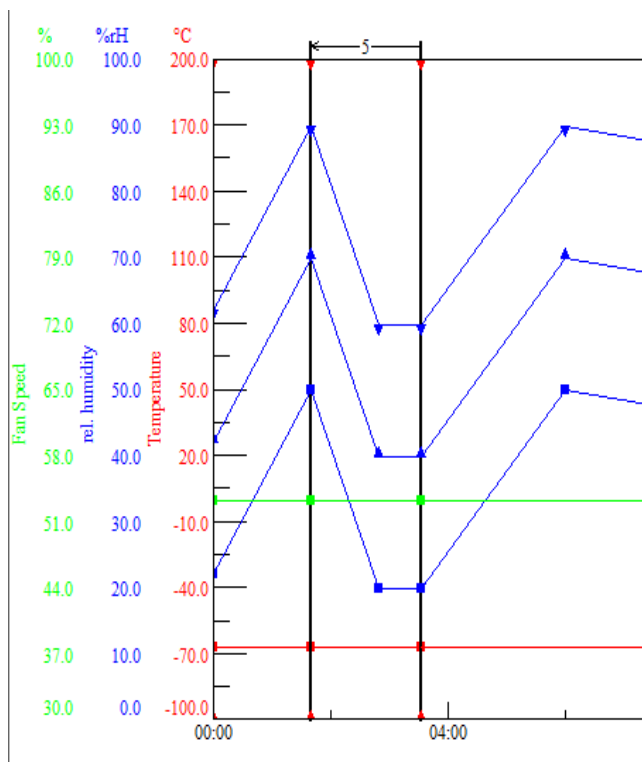

Fig. 8-29: Loops

Mind that the beginning of a loop must always be to the right of its end.

Delete loop:

- ▶ Double-click on the beginning or end of the loop.
- ▶ Move beginning or end of loop

If you want to import the test program to the symbolic editor, please take the following into account when you program a loop so that the test program converts properly:



- ▶ Enter a short dwell time (1 - 60 sec. depending on the test program) between the loop end of the first loop and the loop start of the second loop.

Otherwise the loop start of the second loop might be shifted in front of the loop end of the first loop.

Jump

Jumps to the specified target profile data point if the condition of this dialog is met.

The second profile data point is set by left-clicking on it.

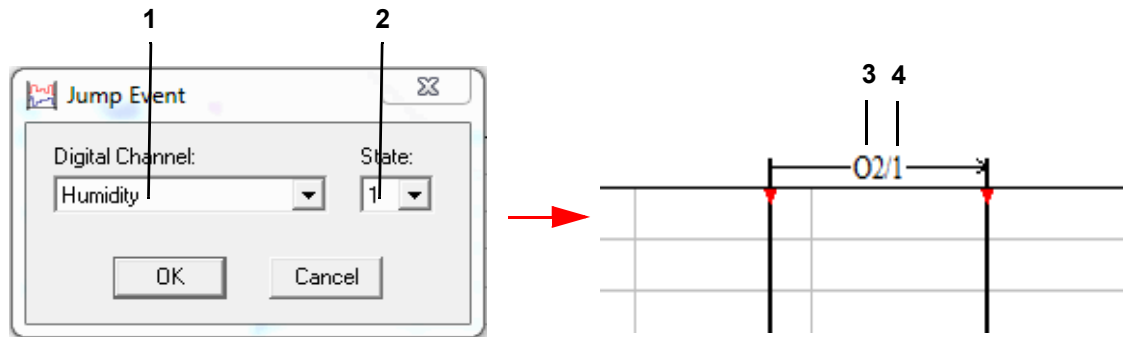

Fig. 8-30: Jump

- 1 Box listing all digital channels.
- 2 Status of the channel selected, 0: channel inactive, 1: channel active.
- 3 Channel number (Item 1).
- 4 Status (Item 2).

Delete jump - double-click on the profile data point.

Wait

If enabled, this function will not allow the test program to continue until the actual value is within the specified tolerance limits. The tolerance is set once for every test program.

→ »Tolerance« (page 122).

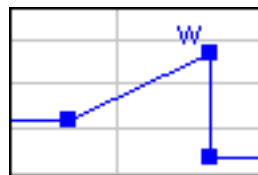

Fig. 8-31: Active Wait function

Using the graphic editor to create test programs

Call program

Another test program (foreground or background program) is to start at this point.

Define a test program as a foreground / background program.

→ »General profile settings« (page 120)

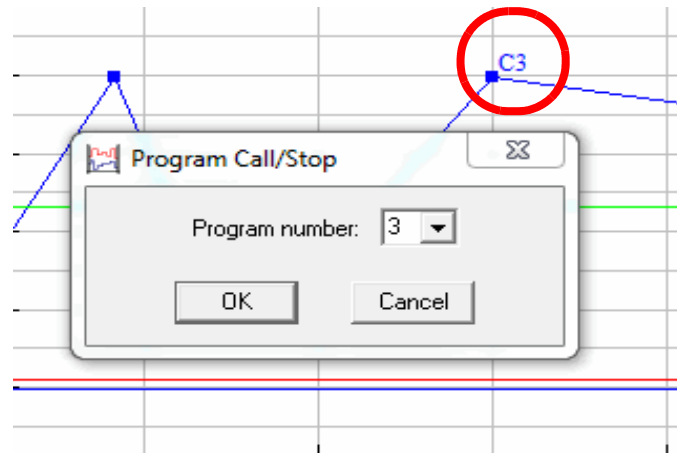

Fig. 8-32: Profile data points

The profile data point is indicated by »C« and the test program number. To disable this function click on its item again on the context menu.

Stop program

A test program is to be stopped at this point. The profile data point is indicated by »S« and the test program number. To disable this function click on its item again on the context menu.

Edit time

This function is used to extend (Item 1) or shorten (Item 2) the length of the test program.

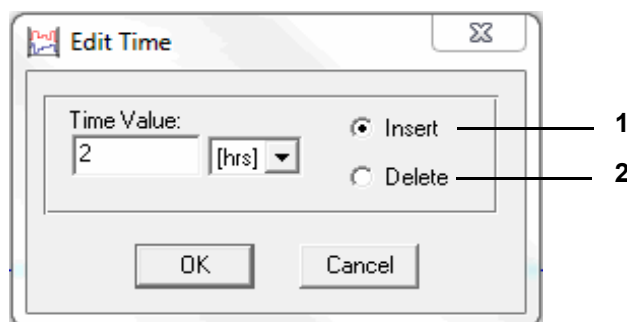

Fig. 8-33: Edit time

The value entered applies to the right side of the profile data point selected.

8.4 Using the tabular editor to create test programs

Use the context menu of the chamber to access this menu.
 → 5.1.3 »Context menu for test systems« (page 53)

The tabular editor is immediately usable for chambers with Simpact controller from software version 2.6. Test programs are converted to symbolic editor format prior to processing. As a result, virtually any chamber can be operated using this format.



If you want to use the tabular editor for chambers involving other controllers, then specific configurations need to be made for this purpose.

► Contact our service centre.

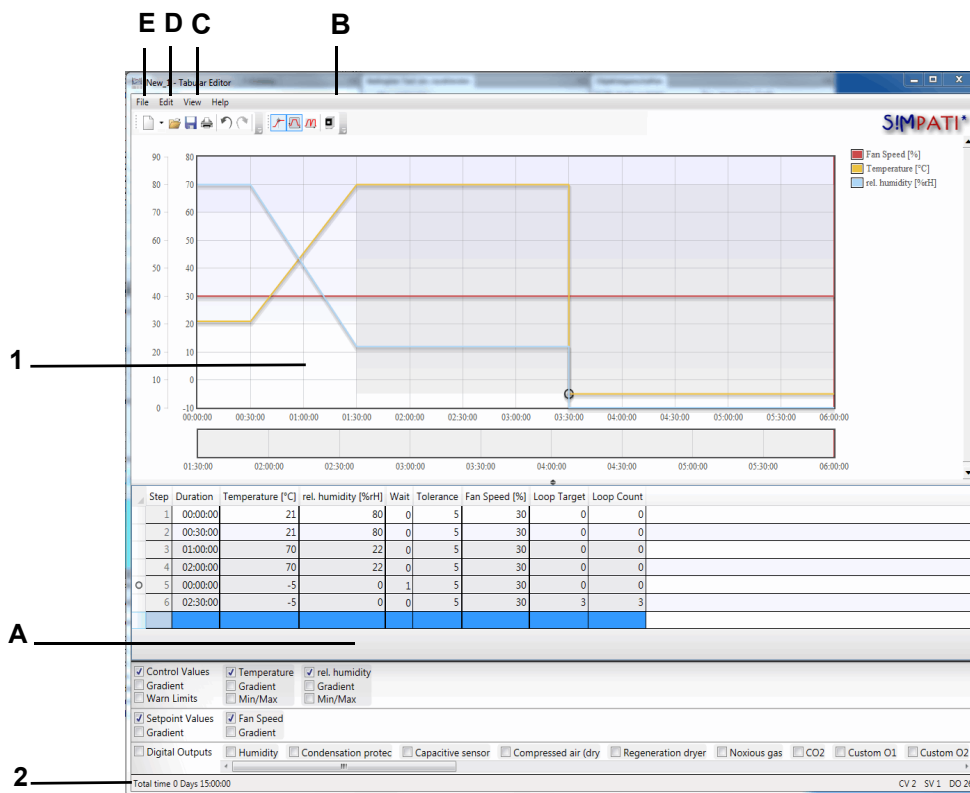

Fig. 8-34: Overview

- 1 Preview.
- 2 Status bar.
- A: Test program table.
- B: Function extension.
- C: View menu function.
- D: Edit menu.
- E: File menu function.

Using the tabular editor to create test programs

8.4.1 Test program table

The test program consists of a table. Here each row is a test program segment and each column represents a process variable. To program, values for the particular process variable have to be entered in the table.

Setting the duration, a Wait function or a loop function in the first segment is not allowed. This can be done in the proximate segments.

→ »Function extensions« (page 129)

A segment's duration is expressed in hours, minutes, seconds format separated by a colon (hh:mm:ss). When entering the duration this format does not have to be strictly adhered to.



- ▶ If just one colon is entered, hours and minutes are assumed as the input (hh:mm).
- ▶ If no colon is entered, then the input is expressed as minutes.

Example

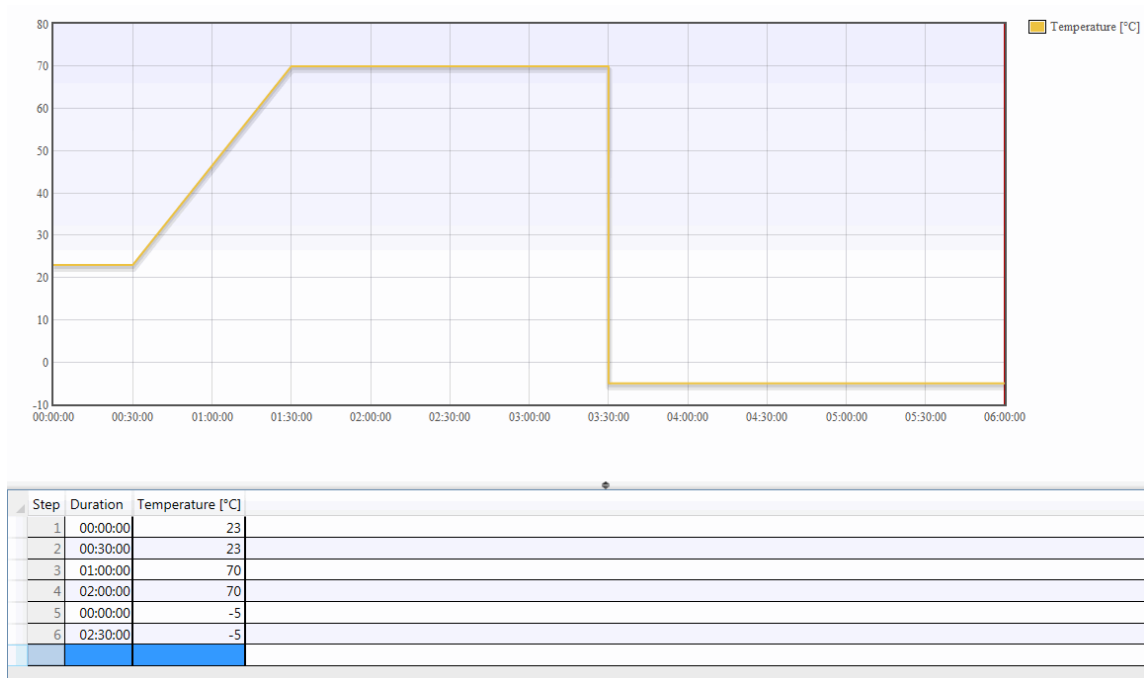

Fig. 8-35: Sample program

Appending a new segment

To append a new segment, a value has to be entered in the blank row at the end of the table.

Attaching a new segment

To attach a new row, menu item Attach has to be selected via the context menu in the table. A new segment is thereupon added in front of the segment currently selected.

Copying segment(s)

Segments selected can be copied via the menu item of the table's context menu or via the keyboard shortcut →»Strg+C«.

Pasting segment(s)

Segments copied can be pasted via the menu item of the table's context menu or via the keyboard shortcut →»Strg+V«.



- Open the table's context menu with a right-click on the table.

Function extensions



Wait function

The Wait function causes the program runtime to be paused until the actual value is located within the tolerance defined. Two columns are displayed by activating the button.

The »Wait« column indicates which control variable is to be expected in the segment. The control variable index has to be referenced here.

The »Tolerance« column indicates how big the maximum deviation may be in order for the program runtime to be able to continue. The tolerance value in the control variable unit has to be checked here.



Wait functions are displayed by a circle in the preview dealing with their control variables set, provided the control variables and waits are viewable. If a wait function is set in the segment, a circle is always displayed to the left of the row in the table



Loop functions

The loop function is used to repeat a section of the test program several times. Two columns are displayed by activating the button.

The »Loop target« indicates the segment number from which the loop begins. This means the end of the loop is the segment in which the loop target is indicated. The loop target must be at least smaller by two than the segment number in which the loop is specified.

The »Loop number« column indicates how often the section defined in the test program is repeated.



The loop functions block is displayed in the preview as a shaded rectangle, provided loops are viewable. The rows in the table whose segments are associated with loop functions are always coloured. In case of nested loops, the inner loops are coloured darker than the outer ones.



Extended preview

By activating the extended preview, any loop programmed is expanded in the preview. As a result, the test program can be viewed in the overall duration.

Using the tabular editor to create test programs

Example:

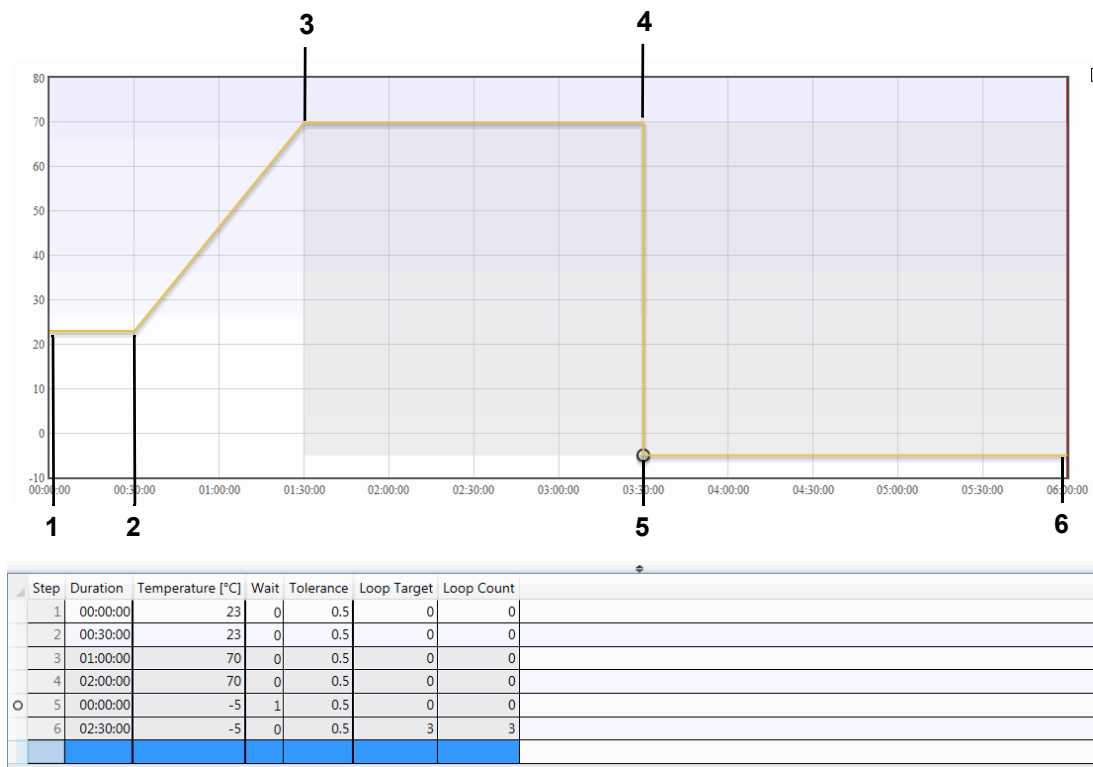

Fig. 8-36: Sample extended view

- 1 Start value for the program sequence.
- 2 No change in temperature, a constant temperature is used for the specified time.
- 3 Change in temperature with concurrent input of a duration. Ramp travel from the previous to the newly set temperature within the time set under Duration.
- 4 See point 2.
- 5 Change in temperature with a duration of 0 and activation of a wait function. Jump from the previously set temperature to the newly set temperature. Thanks to the wait function, the continuation of the program run is stopped until the chamber's actual value has reached the new target value less the tolerance set.
- 6 Once the constant has been started, the program sequence returns via the input of a loop number and a loop target to the program point entered. This is repeated as often as it has been input under loop number.

8.4.2 The "View" menu function

Preview

Showing / hiding the preview: Every piece of the current test program's process data shown for programming is displayed here.

Column selection

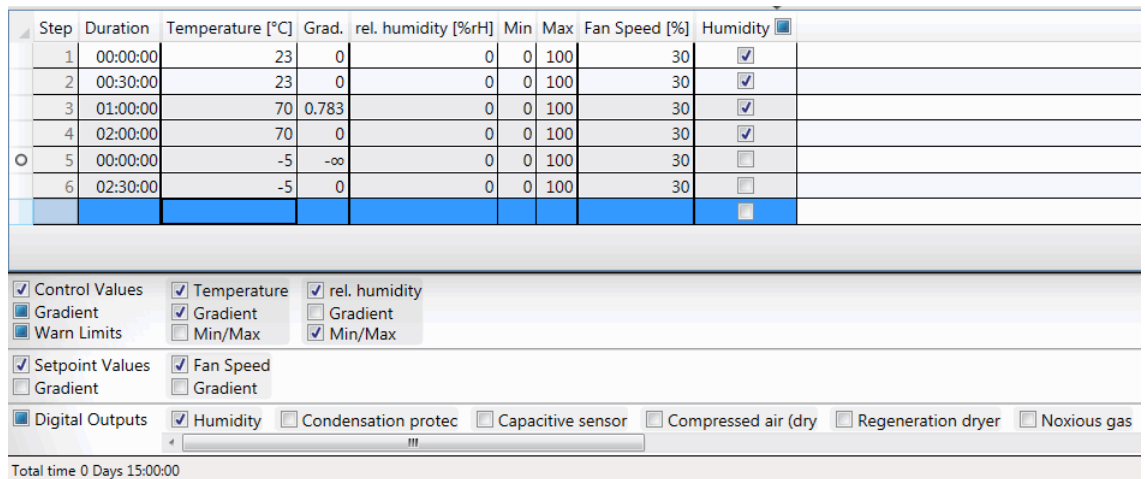

Fig. 8-37: Column selection

Showing / hiding the column selection. Here, process data in columnar form can be shown and hidden. In the case of control variables, the gradient and the warning limits can be shown and edited in addition to each control variable. The gradient is also available for any target value.

Status bar

Showing / hiding the status bar. The status bar indicates the total duration and displays a profile overview of the test program. The profile overview indicates the number of control variables, control values and digital outputs in short form.

8.4.3 The "Edit" menu function

Undo / Redo

Changes in the test program can be undone and redone too. This does not include changes in the configuration.



All undo and redo steps are inoperative in respect of changes in the configuration.

Cut/Copy/Paste

Segments can be cut, copied and pasted into any other tabular test program.

Using the tabular editor to create test programs

Program configuration

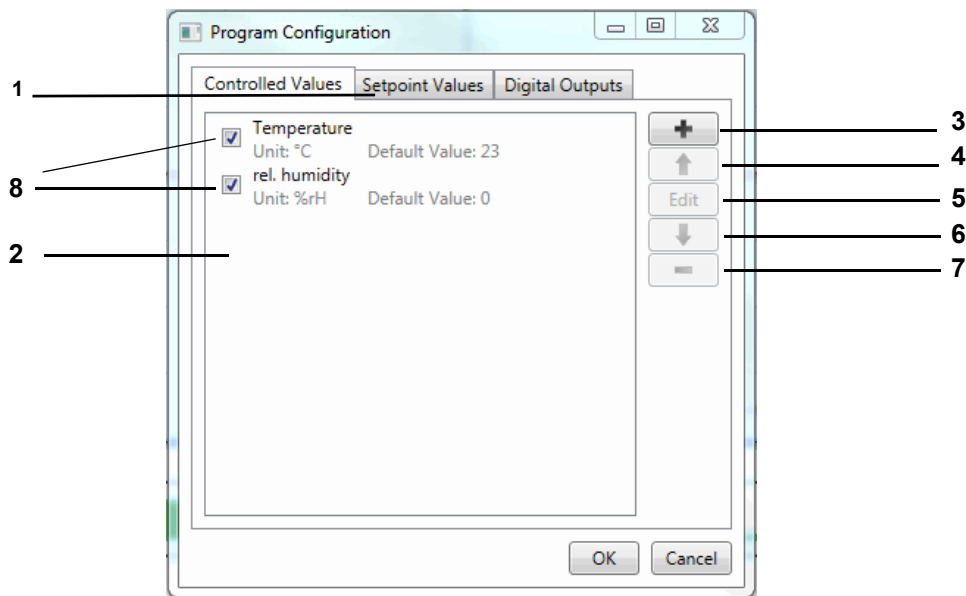

Fig. 8-38: Program configuration

- 1 Process data selection.
- 2 Process data list.
- 3 Add process variable (available for service personnel only).
- 4 Move process variable up.
- 5 Edit process variable.
- 6 Move process variable down.
- 7 Remove process variable.
- 8 Activate / deactivate process variable.

Only activated process variables are transferred on converting to the symbolic program format; all other process variables are constrained to standard values or the last value set (can be decided on export).

Settings

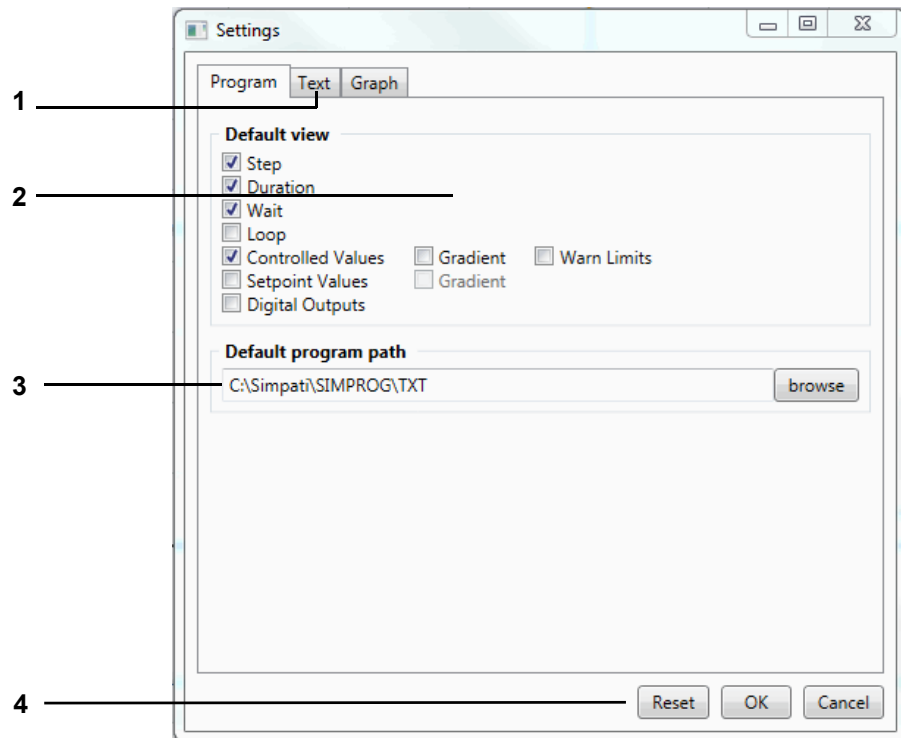

Fig. 8-39: Program settings

- 1 Select context of setting.
- 2 Default view of new and open test programs.
- 3 Suggested default path for saving.
- 4 Reset all settings.

Using the tabular editor to create test programs

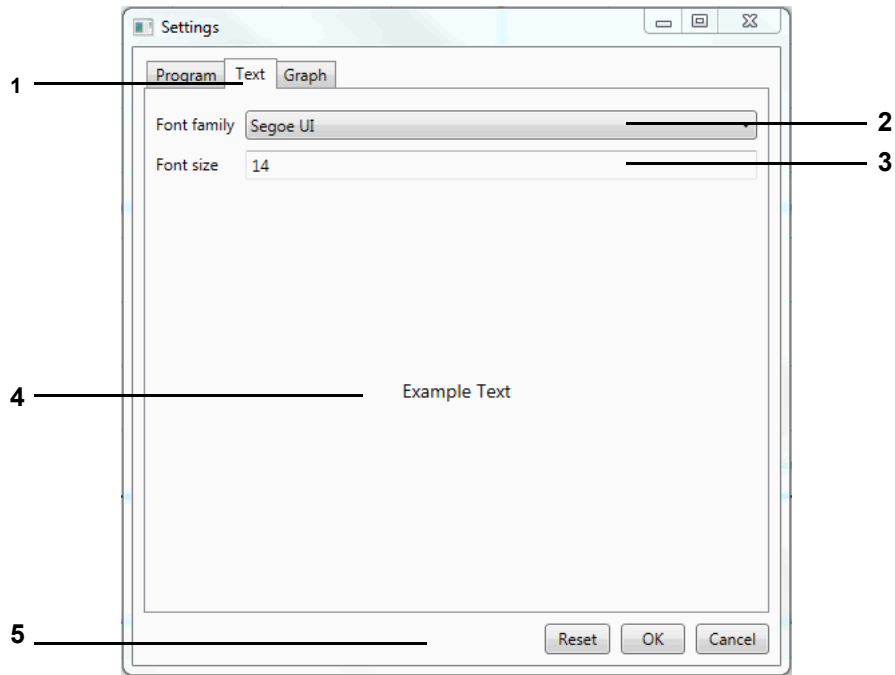

Fig. 8-40: Settings Text

- 1 Select context of setting.
- 2 Select an editor font.
- 3 Select an editor font size.
- 4 Preview of text settings.
- 5 Reset all settings.

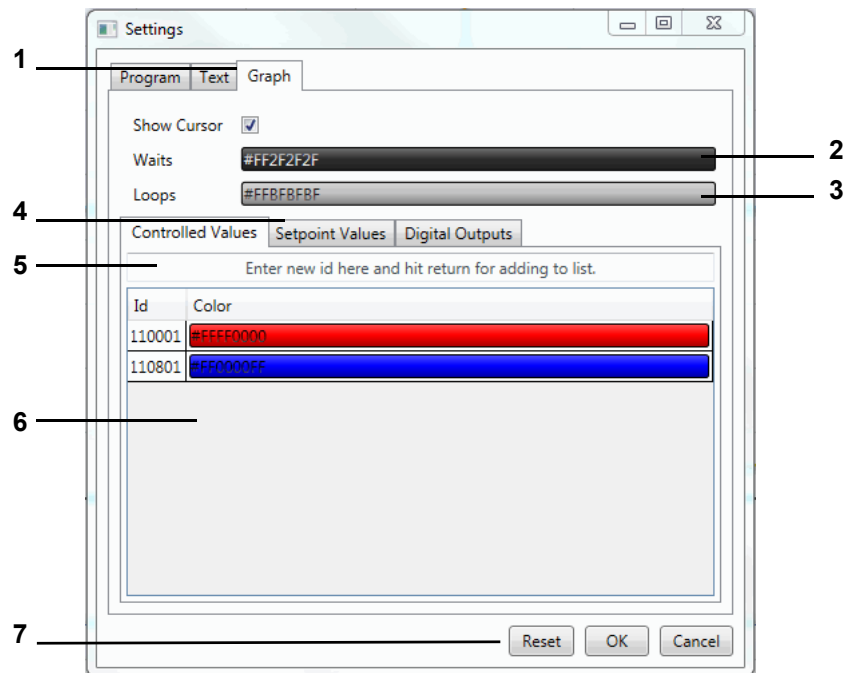

Fig. 8-41: Settings Graph

- 1 Select context of setting.
- 2 Colour of waits in the test program (set by clicking).
- 3 Default colour of loops in the test program (set by clicking).
- 4 Process data selection.
- 5 Selects a distinct process variable assignment for the colour assignment list.
- 6 Colour assignment list (set colours by double-clicking).
- 7 Reset all settings.

Using the tabular editor to create test programs

8.4.4 "File" menu function

New

On the basis of a selected chamber

A new test program is created on the basis of the chamber for which the tabular editor was opened.

On the basis of another chamber

A new test program is created on the basis of a chamber that was selected from a selection list.

On the basis of a profile

A new test program is created on the basis of a profile (of a program configuration) that was read from a file.

On the basis of a user-defined chamber

A new test program is created on the basis of a program configuration that was defined by a user.
→ See [section D\) Program configuration](#)

Open

A test program created with the tabular editor can be opened here.

Save / Save As

These functions are used to save the test program with its own name or with a new test program name.

Use only letters, numbers and the understroke key for the test program name.



When Simpati is used for service installation, the error message "File path cannot be reached" appears on opening or saving a file because Windows attempts by default to navigate to the desktop of the user logged in while the navigation pane in the folder view is activated.

- ▶ To prevent this, remove the check in the Windows Explorer folder view under Organise --> Layout --> Navigation pane.
-

Export

Template

The test program's profile (the program configuration) is saved in a file that can be used as a template for other programs.

Symbolic program

The test program for the destination chamber selected is converted to the symbolic program format with the assist of a selection menu.

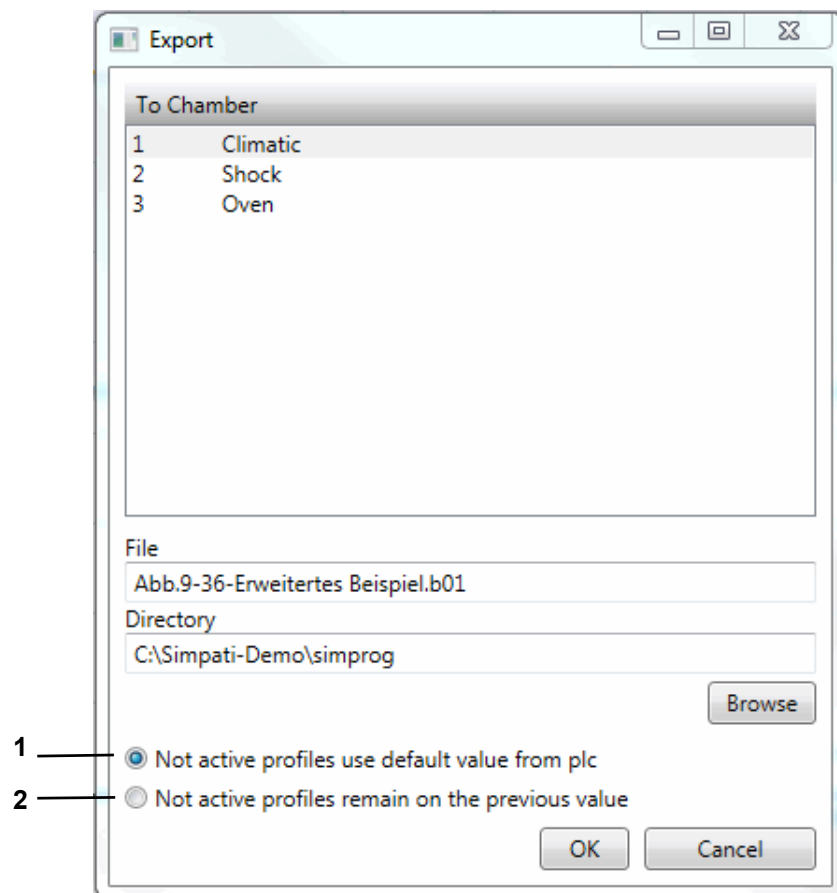

Fig. 8-42: Test program – Export

- 1 Inactive profiles are switched to their standard values and displayed in the symbolic editor.
- 2 Inactive profiles are switched to the previous value set and not displayed in the symbolic editor.

Print

The full test program is printed from the preview, provided displayed, in list form.

Creating test programs for a shock test chamber

8.5 Creating test programs for a shock test chamber

Use the context menu of the chamber to access this menu.

→ 5 »SIMPATI® Main screen« (page 49) (»ShockTest Editor«)

8.5.1 Creating test programs for shock chambers with a DMR controller

You can run the text editor for writing test programs for shock chambers with a DMR controller only if a DMR controller is actually attached.

The test program is stored in two formats: as a *.pxx (file for the graphical editor) and as a *.cfg file (for the shock chamber editor). It is possible to display a program file created using the shock chamber editor in the graphical editor and further edit it.

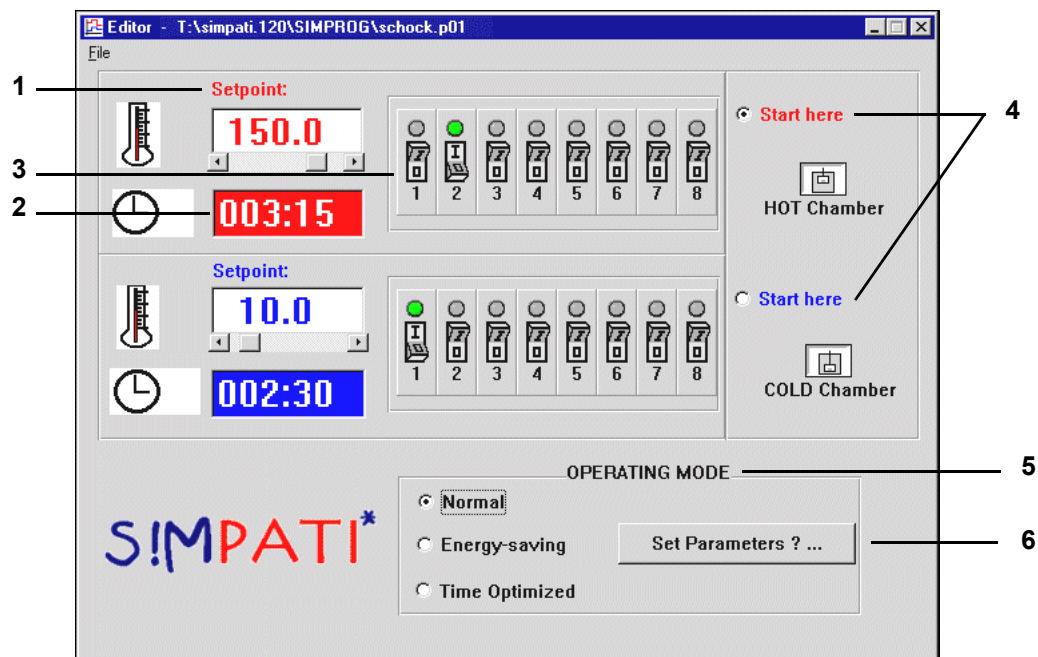

Fig. 8-43: Editor

- 1 The nominal values for the hot / cold chamber can be set directly via the keyboard or the scroll bar. If a value is entered which exceeds the range limits, it is automatically reset to the upper or lower limit.
- 2 The time the basket will stay in the hot or cold chamber is set using the keyboard and the following format: XXX:YY; X = hours, Y = minutes). Only hours (up to 999) and minutes (up to 59) are allowed. A minute value ≤ 60 will be reset to 59 minutes on saving, i.e. invalid values are not saved.
- 3 In addition to the chamber temperature and the chamber dwell time, up to eight customer outputs can be programmed. The status of the channels can be changed by simply clicking on the eight switch symbols for the hot / cold chambers.
- 4 Another click lets you decide whether to start the program in the hot or cold chamber.
- 5 You can choose from various operating modes. The following differences exist between the operating modes:

Normal

Nominal temperatures are set and controlled in normal mode.

To achieve a quicker temperature change in the test specimen when changing chambers, the chamber in which the lifting basket is not present can be pre-heated/-cooled to a higher or lower nominal value (inactive nominal value). Once the basket has moved into the pre-heated or cooled chamber, the active nominal value is reset.

Use the dialog below to modify the inactive nominal value (default: +/-5 °C) by selecting the text box and entering the value.

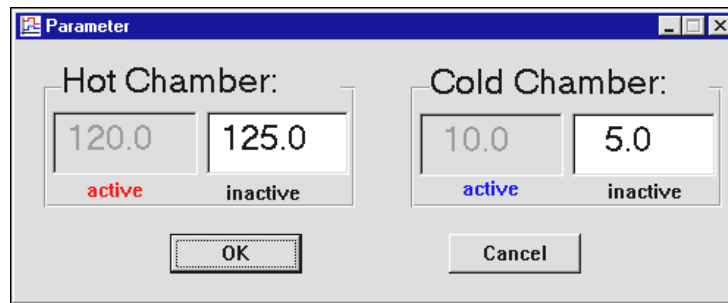

Fig. 8-44: Normal

Energy saving mode

In the case of long cycle times, the temperature of the chamber in which the lifting basket is not present has a nominal value of 23°C.

Use the Item 6 function → Fig. 8-43: »Editor« (page 138) to enter a warm-up time; during this time, the active nominal value is set before the lifting basket is moved so that the 23 °C is overwritten.

Creating test programs for a shock test chamber

Time-optimised mode

In time-optimised mode, it is possible to specify an inactive nominal value just as in normal mode; this means that the chamber in which the lifting basket is not located is pre-heated or super-cooled in this mode as well.

In time-optimised mode the temperature change is further accelerated by specifying absolute nominal value adaptation for the active nominal value. This adapted nominal value is maintained until the temperature at the lifting basket temperature sensor reaches a definable tolerance range (absolute with respect to the active nominal value). Then the active nominal value is set automatically. This mode guarantees that the test specimen is in the chamber at the nominal value required for the entire dwell time (cycle time).

Hot Chamber:		Cold Chamber:	
150.0	155.0	10.0	5.0
active	inactive	active	inactive
Tolerance MIN:	- 5 °Deg	Tolerance MIN:	- 5 °Deg
Tolerance MAX:	+ 5 °Deg	Tolerance MAX:	+ 5 °Deg
Adaption of Set Point:	5 °Deg	Adaption of Set Point:	5 °Deg
OK		Cancel	

Fig. 8-45: Time-optimised

Enter the inactive nominal value as you entered the normal mode. Again, a wrong entry will provoke error messages.

Example: → A: 3 »Example program for a shock chamber with a DMR controller« (page 254)

8.5.2 Creating test programs for shock chambers with a CTC controller

Text editor for writing test programs for 2x and 3x shock chambers with a CTC controller. This test program can only be called up when the controller is a CTC and the configuration has the type set to 2x / 3x shock chamber.

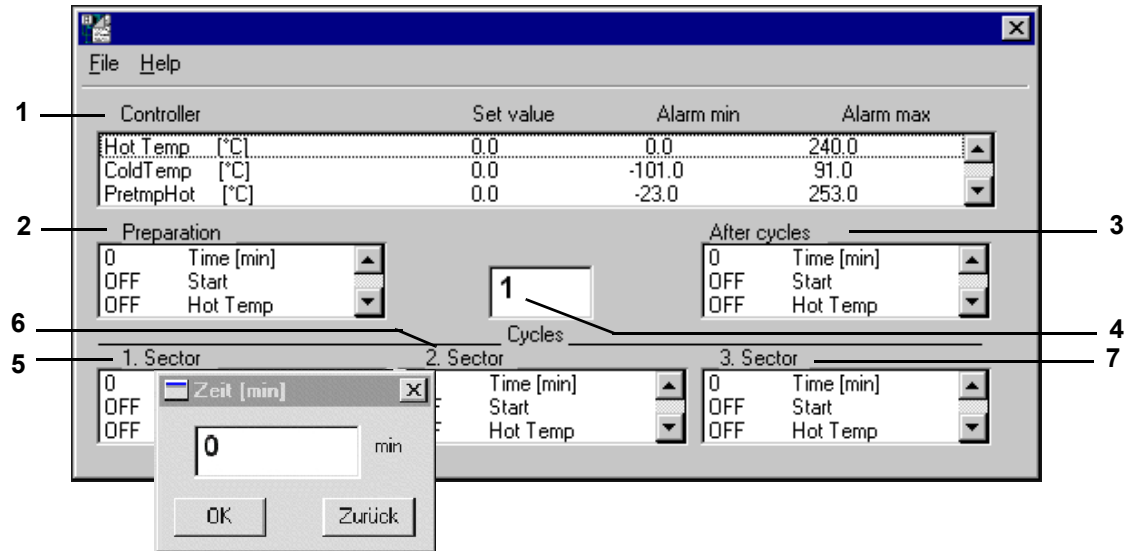

Fig. 8-46: Creating a test program

Double-click on a line to change the settings. A shock chamber test program is divided into three sub-test areas:

- Pre-conditioning (before the loop).
- Cycles (actual test program).
- Post-conditioning (after the loop).

After saving, the test program can be checked or if necessary modified using the preview in the graphic editor (e.g. subsequent addition of wait functions in the temperature profile of the hot / cold chamber).

Creating test programs for a shock test chamber

Description of the settings

- 1 List box of all control variables with nominal values and alarm limits.
Double-click on the corresponding line to open a window to modify the nominal values or alarm limits. Try not to make the alarm limits too tight because the offset of the basket may briefly cause significant discrepancies between nominal and actual values.
- 2 before the loop (pre-conditioning)
Allows you to settle the test specimen to a defined initial temperature before starting the actual test, as appropriate.

Enter the status of the digital channels as required before the start of the loop execution (cycles). The status can be changed by double-clicking on a channel name. The default time setting is 1 minute. The time is set by double-clicking on Time [min] and entering the required time in the time input window. The minimum time of 1 minute is required to correctly execute the test program.
- 3 after the loop (post-conditioning)
Allows you to settle the test specimen to a defined final temperature after completing the test cycles, as appropriate.

Here, the status of the digital channels as required after the execution of all the loops (cycles) must be entered (e.g. 10 min Defrost = ON).

The status can be changed by double-clicking on a channel name.

Again, the default time is 1 minute. The time is set by double-clicking on Time [min] and entering the required time in the time input window. The minimum time of 1 minute is required to correctly execute the test program.
- 4 Completes the cycles at the temperatures set in the various sections. Enter the number of cycles (number of loops) required.
- 5 1st section
Here, enter the dwell time for the particular chamber (e.g. hot chamber) and the status of the digital channels (e.g. Basket up = ON).

The status can be changed by double-clicking on the channel name. Set the time by double-clicking on Time [min] and entering the time required in the time input box. Assignment of a section to a specific chamber is executed via the digital channels Lifting Basket UP (hot chamber), Lifting Basket MIDDLE (middle chamber, in 3x shock chambers only), Lifting Basket DOWN (cold chamber). Only one of the three digital channels may be set in any one section. If the cycle time set is only to be executed when the nominal / actual deviation is within the wait tolerances (+/- 5°K), use the graphical editor to enter a data point with the wait function → »General profile settings« (page 120) in the corresponding nominal value curve → Appendix: »Examples« (page 245). It makes sense in this instance to only activate the wait function for approx. 3 minutes after the lifting basket is moved so that the temperature in the lifting basket (and therefore the actual temperature value) can match the new ambient temperature. If the dwell time is 0, this section is skipped.

6 2nd section

Here, enter the dwell time for the particular chamber (e.g. middle chamber) and the status of the digital channels (e.g. Basket MID = ON).

The status can be changed by double-clicking on the channel name. Set the time by double-clicking on Time [min] and entering the time required in the time input box. Assignment of a section to a specific chamber is executed via the digital channels Lifting Basket UP (hot chamber), Lifting Basket MIDDLE (middle chamber, in 3x shock chambers only), Lifting Basket DOWN (cold chamber). Only one of the three digital channels may be set in any one section. If the cycle time set is only to be executed when the nominal / actual deviation is within the wait tolerances (+/- 5°K), use the graphical editor to enter a data point with the wait function in the corresponding nominal value curve → *Appendix: »Examples« (page 245)*. It makes sense in this instance to only activate the wait function for approx. 3 minutes after the lifting basket is moved so that the temperature in the lifting basket (and therefore the actual temperature value) can match the new ambient temperature.

If the dwell time is 0, this section is skipped.

7 3rd section

Section 3 is only required for the 3x shock chamber.

In this chamber, the hot chamber is programmed in section 1, the middle chamber in section 2 and the cold chamber in the section 3.

Here, enter the dwell time for the particular chamber (e.g. cold chamber in the 3x shock chamber) and the status of the digital channels (e.g. Lifting Basket DOWN = ON). The status can be changed by double-clicking on the channel name. Set the time by double-clicking on Time [min] and entering the time required in the time input box. Assignment of a section to a specific chamber is executed via digital channels Lifting Basket UP (hot chamber), Lifting Basket MIDDLE (middle chamber) and Lifting Basket DOWN (cold chamber). Only one of the three digital channels may be set in any one section. If the cycle time set is only to be executed when the nominal / actual deviation is within the wait tolerances (+/- 5°K), use the graphical editor to enter a data point with the wait function in the corresponding nominal value curve → *Appendix: »Examples« (page 245)*. It makes sense in this instance to only activate the wait function for approx. 3 minutes after the lifting basket is moved so that the temperature in the lifting basket (and therefore the actual temperature value) can match the new ambient temperature. If the dwell time is 0, this section is skipped.

Creating test programs for a shock test chamber

8.5.3 The »File« menu function

New

Enter a new test program name.

Open

Loads a test program. If a shock test program is not involved, then this program is treated like a shock test program (before the loop, section 1, section 2, etc., after the loop).

Save / Save As

Save the input shock test program under the current name. The DMR format is used as the save format.

If a test program is saved, in which section 2 is skipped with a dwell time of 0, then section 3 (if this has been programmed) is automatically assigned to section 2 when the program is re-opened. The same applies to "Save as".

Print

Print test program.

Sample program → *Appendix: »Examples« (page 245)*,

8.5.4 Creating test programs for shock chambers with a Simcon and Simpac controller

Editor for creating test programs for shock chambers with a Simcon or Simpac controller. Programming for shock chambers with 2 or 3 chambers differs only in that the middle chamber is not displayed for 2-chamber shock chambers.

Two formats are available for saving the test program:

*.pxx (graphic editor file) and *.bxx (shock chamber editor file).

It is possible to display a program file created using the shock chamber editor in the graphical editor and further edit it. Test programs modified in the graphic editor can be reimported to the shock chamber editor.

Control value during program creation:



If the control value is not programmed (target value = 0), this leads to error message »A031: Wait function time exceeded« immediately after the program starts.

► If control value 3 "Max. Temp.ChangeTime" enter a nominal value of at least 15 minutes.



→ *Appendix: »Operation of TS130 model shock chambers with Simcon/32 controller« (page 239)*



Chamber configuration for a shock chamber:

► Make sure that the type is set to a 2x or 3x shock chamber in the chamber configuration.

→ *6.1 »General chamber configuration« (page 78)*

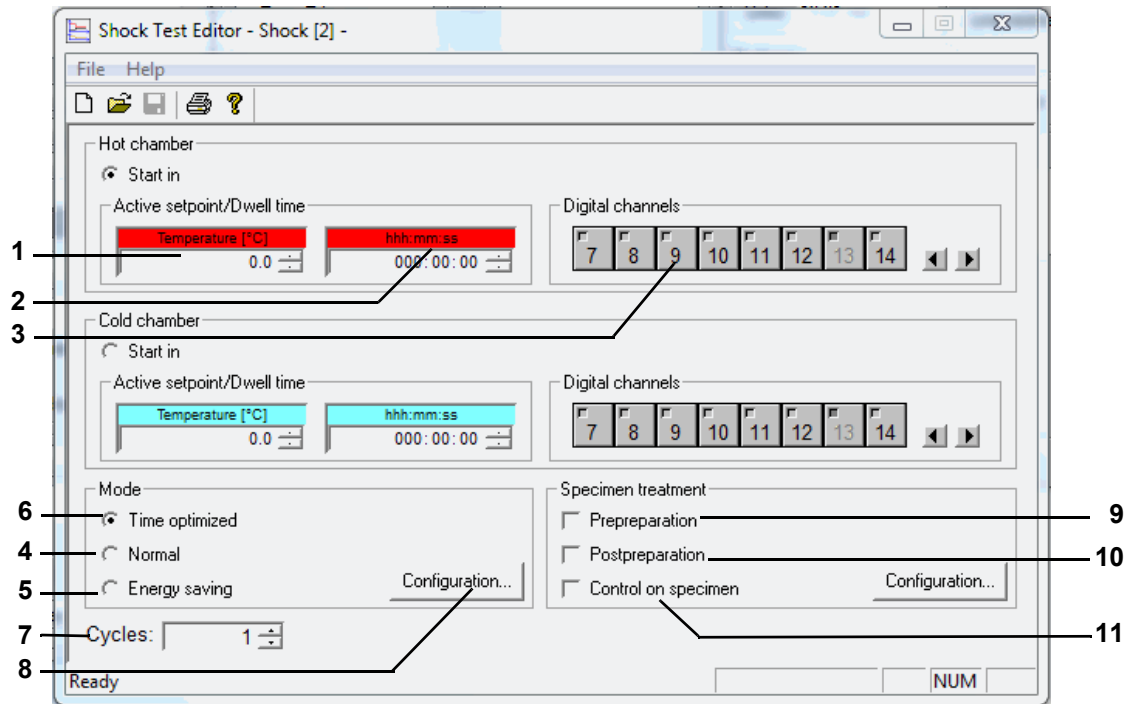

Fig. 8-47: Shock chamber editor (Simcon, Simpac)

- 1 The test takes place at the temperature entered here. If a nominal value is entered which exceeds the range limits, it is automatically reset to the upper or lower limit.
- 2 If the chamber has reached the configured nominal value, the basket remains in this chamber for the period of time entered here.
- 3 A single click on the switch icons of the digital channels changes the state of the digital channels. Digital channels that appear inactive (light grey) are set indirectly, i.e. via other menu windows.

3-chamber shock chamber

When the dwell time has timed out once in every chamber, the cycle ends in the middle chamber if further cycles are to be completed. If this is not the case, the lifting basket moves into the hot chamber, provided nothing else has been specified for the end chamber in the menu window → »Test specimen treatment« (page 150).

Operating mode

You can choose from various operating modes. The differences described below exist between the operating modes:

Creating test programs for a shock test chamber

Inactive nominal value

To achieve a quicker temperature change in the test specimen when changing chambers, the chamber in which the lifting basket is not present can be pre-heated/-cooled to a higher or lower nominal value (inactive nominal value). Once the basket has moved into the pre-heated or cooled chamber, the active nominal value is reset. The inactive nominal value depends on the mode selected.

- 4 In normal mode the desired temperature nominal values are set and controlled regardless of the position of the lifting basket.
- 5 For long cycle times, the temperature of the chamber in which the lifting basket is not located is not controlled.
- 6 In time-optimised mode it is possible to specify an inactive nominal value just as in normal mode; this means that the chamber in which the lifting basket is not located is pre-heated or super-cooled in this mode as well.

In time-optimised mode the temperature change is further accelerated by specifying absolute nominal value adaptation for the active nominal value. This adapted nominal value is maintained until the temperature at the lifting basket temperature sensor reaches a definable tolerance range (absolute with respect to the active nominal value). Then the active nominal value is set automatically. This mode guarantees that the test specimen is in the chamber at the nominal value required for the entire dwell time.

- 7 The number of chamber changes required is specified.
Once the number of cycles has been processed, the lifting basket automatically moves into the hot chamber.
- 8 Configuration of the operating mode selected → *»"Normal" operating mode« (page 147)*, → *»"Energy-saving" operating mode« (page 148)*, → *»"Time-optimised" operating mode« (page 149)*

"Normal" operating mode

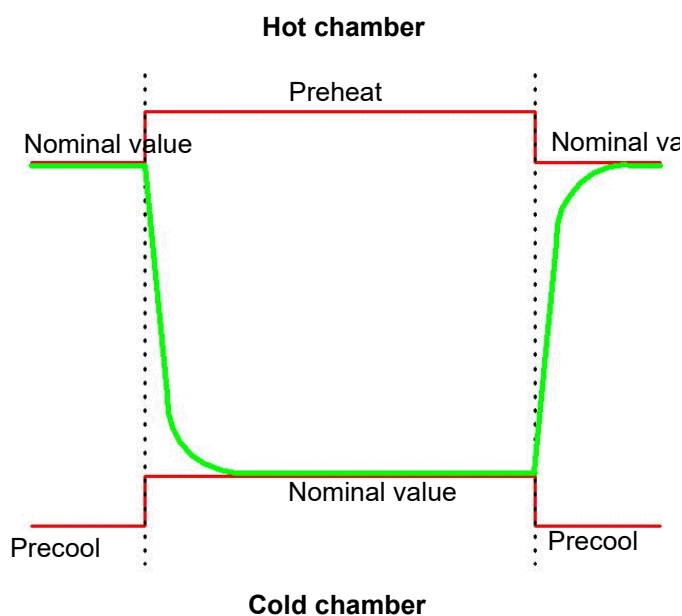
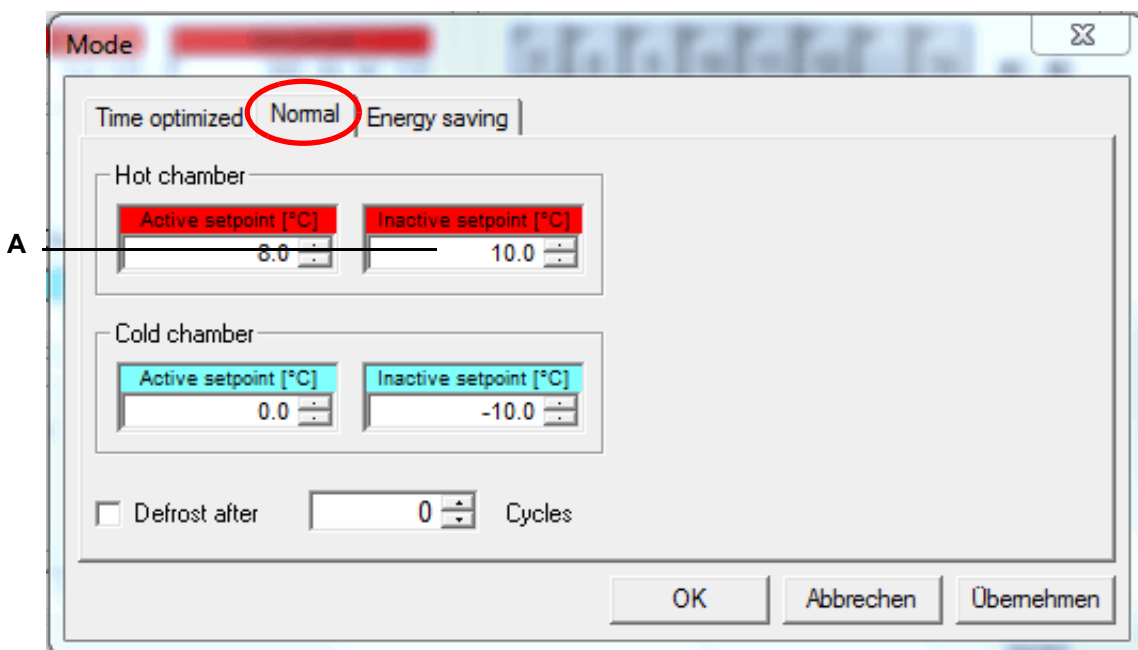

Fig. 8-48: Normal operation

Creating test programs for a shock test chamber

"Energy-saving" operating mode

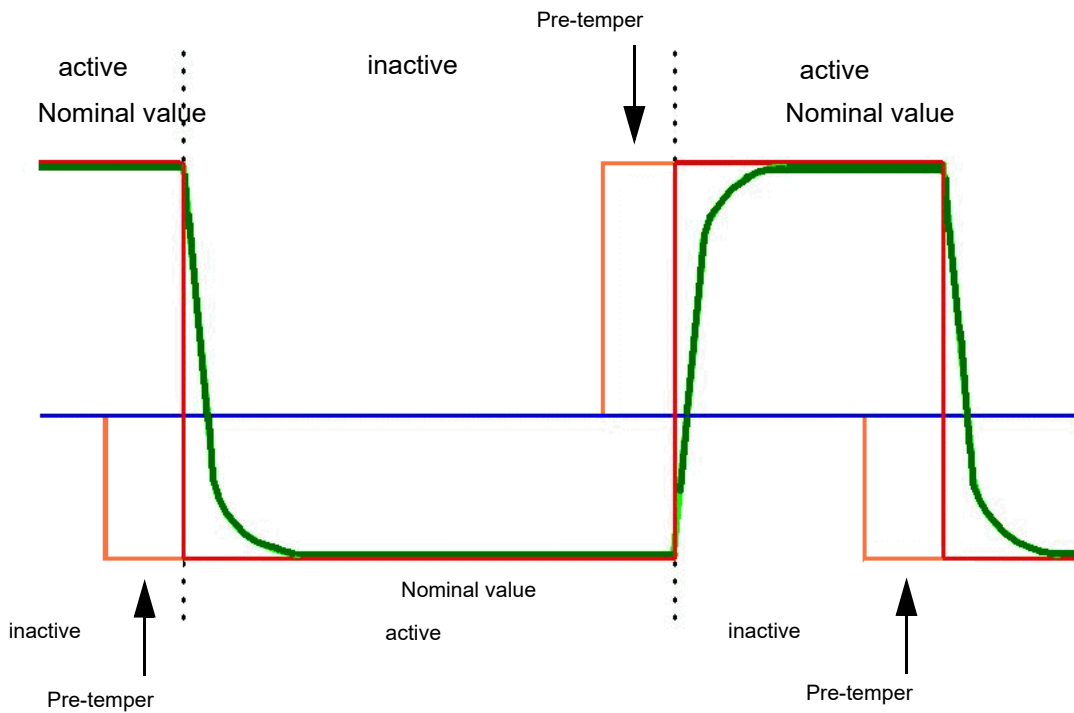
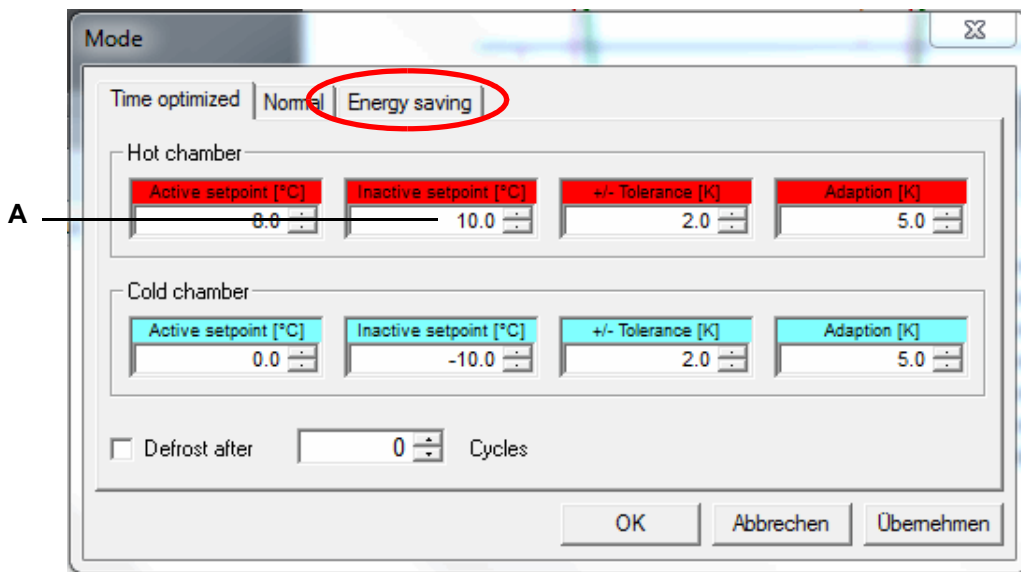

Fig. 8-49: Energy saving mode

"Time-optimised" operating mode

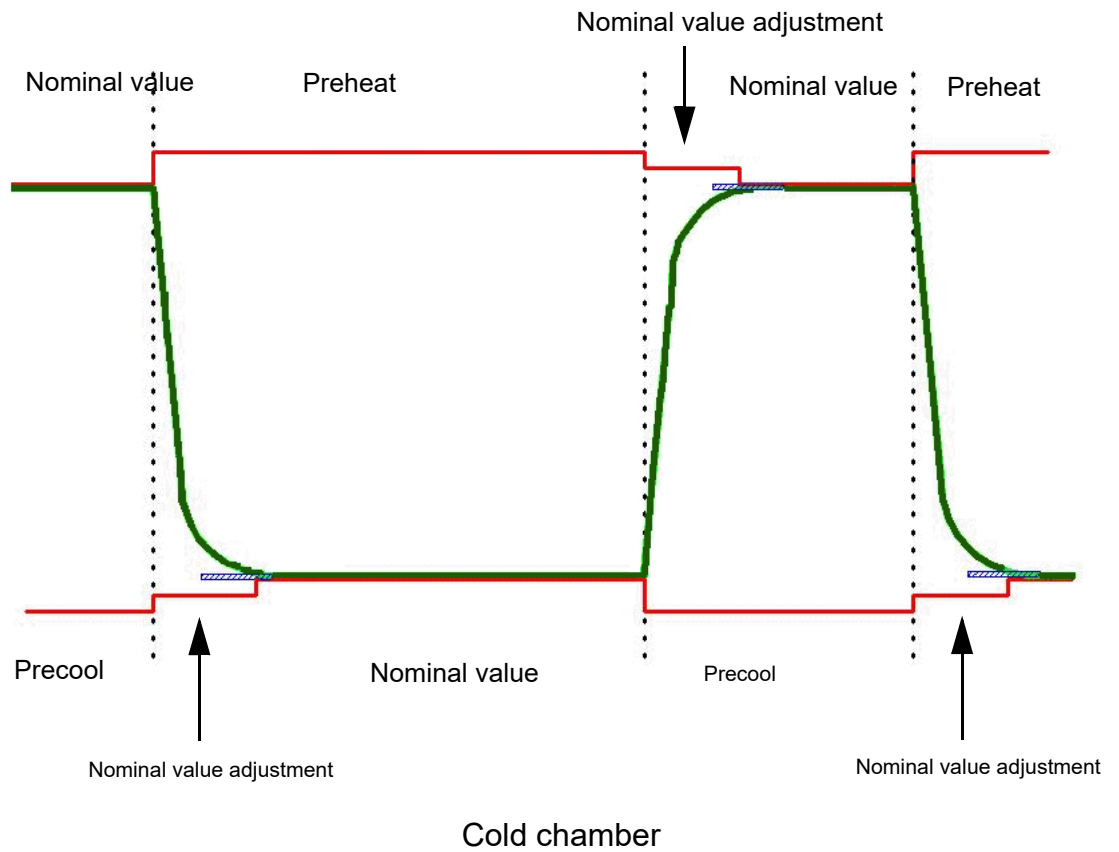
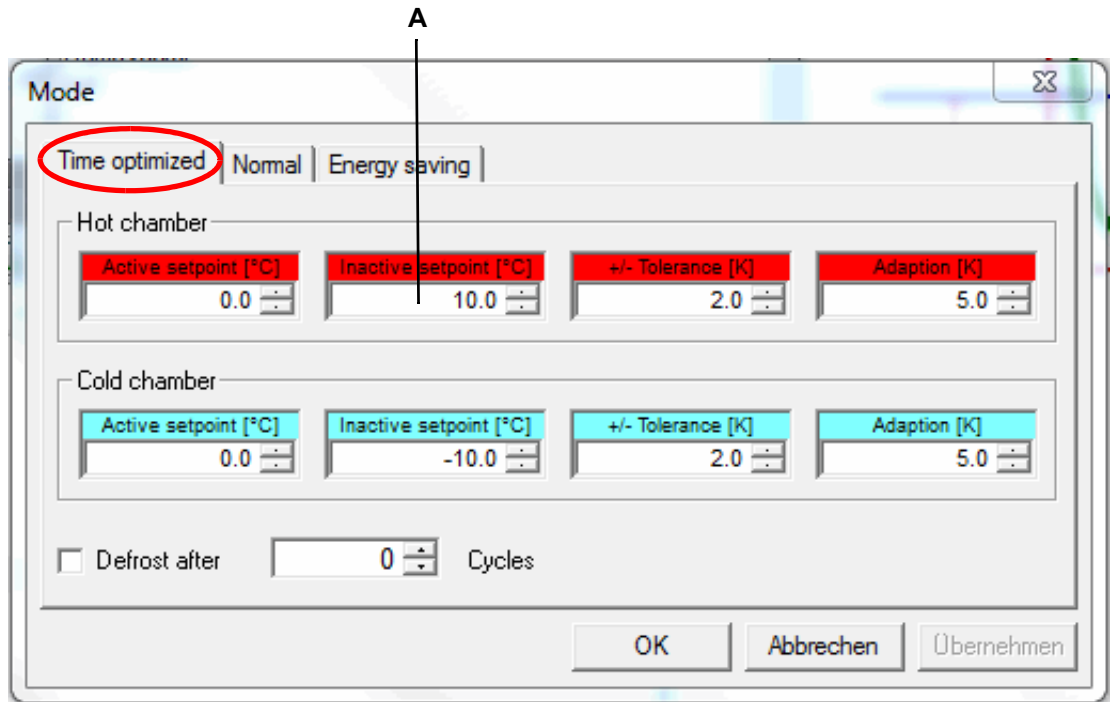

Fig. 8-50: Time-optimised mode

Creating test programs for a shock test chamber

Test specimen treatment

- 9 The test specimen may exhibit a significant temperature difference with respect to the nominal value configured for this chamber once placed in the lifting basket. This is compensated for by settling the test specimen temperature before starting the dwell time.
- 10 After completion of a test, the test specimen temperature is changed as desired, for instance, to prevent burns when removing the test specimen.
- 11 The active nominal value is controlled via the temperature sensor exposed on the test specimen.
You can define in which chamber the test should start and end.

9 TEST PROGRAM TRANSFER BETWEEN THE CHAMBER AND SIMPATI®

Use the context menu of the chamber to access this menu. → 5.1.3 »Context menu for test systems« (page 53), "Program transfer". Before you can start a test program, you must first of all save the test program to the chamber controller. If it has not been set up in the chamber controller at the factory, this means that you need to transfer the program to the chamber controller.



If you use the → 10 »Starting / stopping a test program« (page 153) function to start a test program, you can make the program transfer from the PC to the chamber there as well.

9.1 Loading test programs from SIMPATI® to the chamber controller

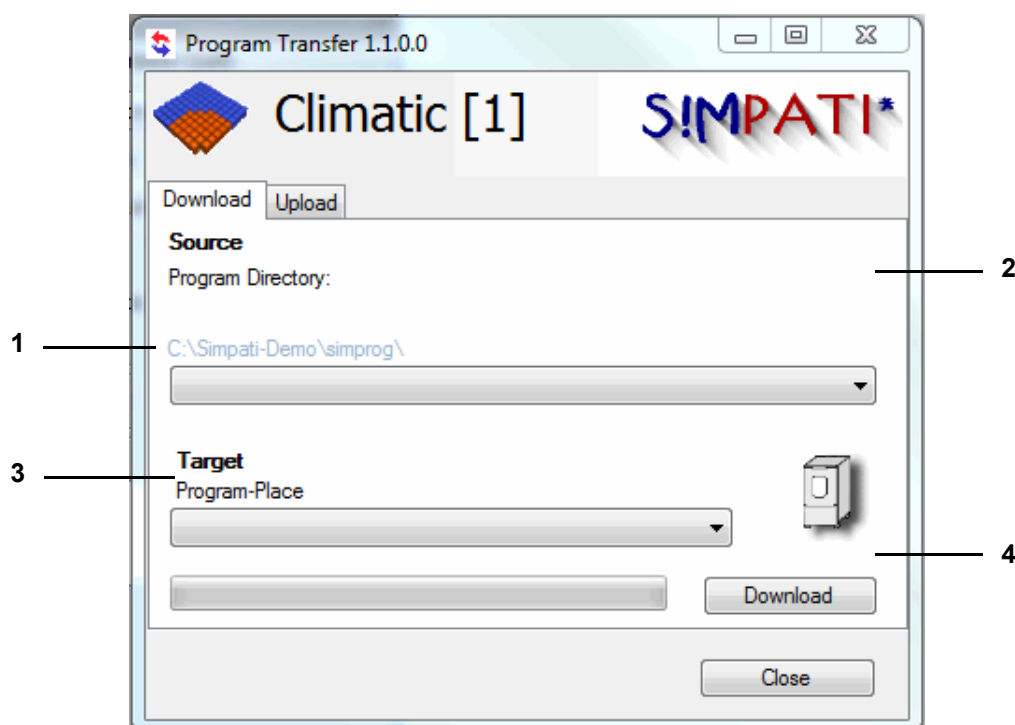

Fig. 9-1: Test program download

- 1 The box lists all test programs saved in the directory above (specify directory).
→ 6.1 »General chamber configuration« (page 78)
- 2 If you have not saved a test program in the directory Item 1, select the directory here and then select the corresponding test program name via the program list Item 1.
- 3 Select the program location in the chamber controller.

ATTENTION

Data loss on account of overwriting existing test programs

Existing test programs are overwritten on confirmation of a message.

- ▶ Do not overwrite test programs carelessly.

- 4 Transfer the test program to the chamber controller.

Loading test programs from the chamber controller and saving them in SIMPATI®

9.2 Loading test programs from the chamber controller and saving them in SIMPATI®

When loading a new test program to the chamber controller select a free program slot so as to prevent any test programs from being overwritten in the chamber controller and to be able to start the test program.

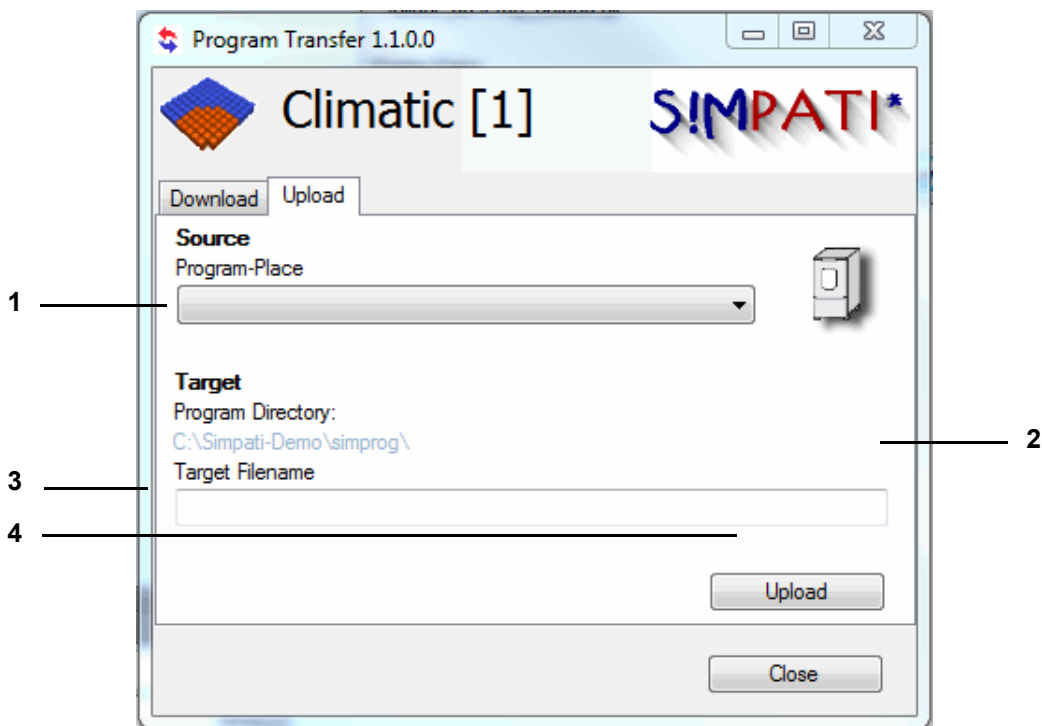

Fig. 9-2: Test program upload

- 1 The box lists all test programs saved to the chamber controller (up to program slot 100).
- 2 Select another directory if you do not wish to save the test program in the specified directory (see on the left, specify directory
→ 6.1 »General chamber configuration« (page 78))
- 3 Save the test program in the directory Item 2. Do not enter a file extension. SIMPATI® will display a prompt if a file of that name already exists.
- 4 Save test program.

10 STARTING / STOPPING A TEST PROGRAM

Use the context menu of the chamber to access this menu.

→ 5.1.3 »Context menu for test systems« (page 53), “Automatic start/stop”.

This function is used to set the start and stop for a test program.

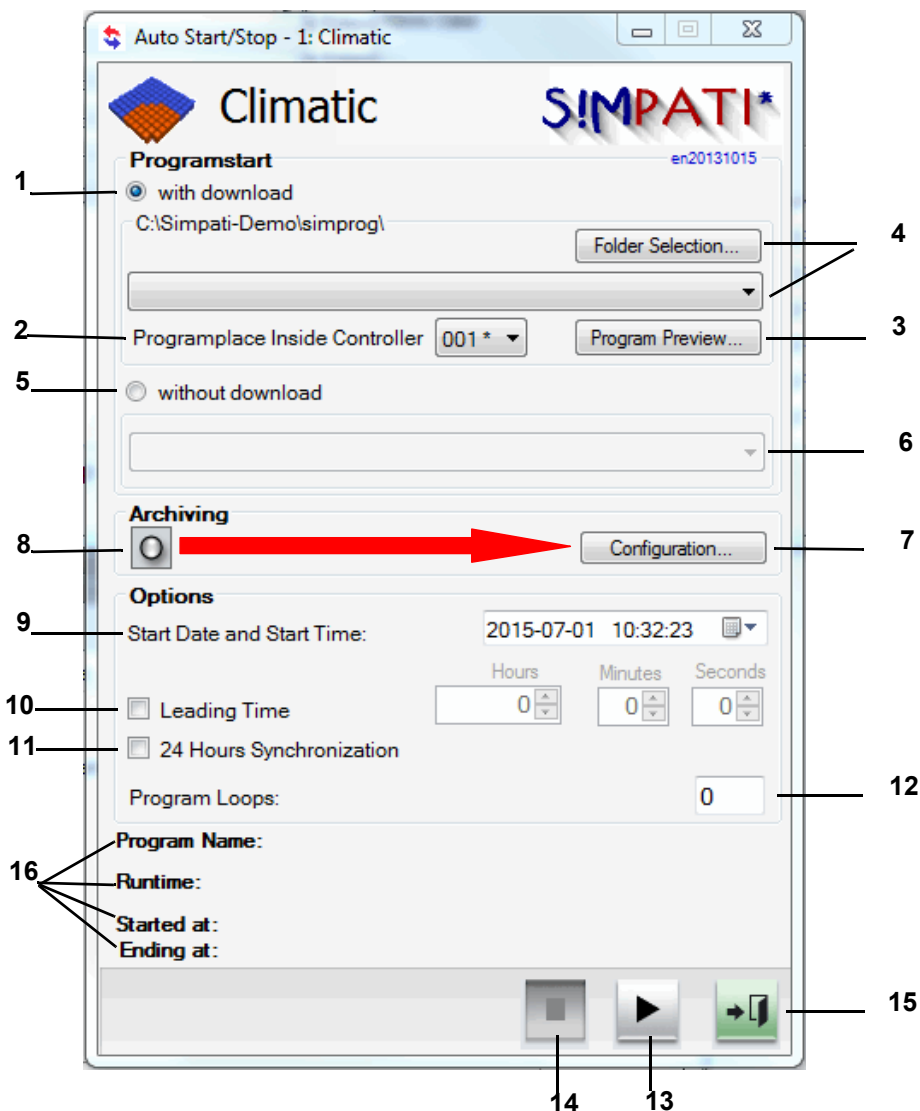

Fig. 10-1: Start/stop test program

If you have not yet uploaded the current test program version to the chamber's controller, you can do this at the start of the test via the function described in → Fig. 10-1: »Start/stop test program« (page 153).

The → Fig. 9-1: Test program download is no longer required as a result.

- 1 Including transfer of program.
The test program is transferred from the computer to the controller and started there.
- 2 Program number in the controller; the test program is uploaded to this program location.
- 3 Graphic program preview of the test program selected.
- 4 Selection of the path in which the test program is located and select test program.
- 5 No transfer of program.
Starts the test program stored in the chamber controller. A program will not be transferred.
- 6 Select the test program which is to be started from the chamber controller.
- 7 Changing archiving settings → 11 »Archiving« (page 155).
- 8 Archive name as specified under → Fig. 10-1: (page 153) (the start date is used if no name is specified).
- 9 Test program start date and time.
If the day entered is in the past, the test program is started immediately.
If the time entered is in the past, the test program is started immediately.
- 10 Enter the time for a program advance. The program will not be processed from the start, but only beginning with the time input.
- 11 Start with 24 hours synchronisation.
The requirement for this function is that both the test program to be started and the loop, foreground and background programs have a length of 24 hours.
If this function has been activated, the test program advances up to the current time; only then is it started, and it runs parallel to the current time.
→ A: 4 »Test program example with program advance« (page 255)
- 12 Number of program repeats: can be input with Simcon, Mincon and Simpac controllers only.



The start of a program will be ignored if it is in a line after the beginning of the loop.

- 13 The test program is started. Before starting the test program, make sure that the adjustable temperature limiter of the chamber is set to a suitable temperature for your test specimen.
The test program can also be interrupted or continued with this button. These functions are only available for certain controllers, however.
- 14 The test program is stopped.
- 15 Close the menu window, the test program will continue to run.
- 16 Display of the current program with program name, running time, start and end time.

11 ARCHIVING

Use the context menu of the chamber to access this menu.

→ 5.1.3 »Context menu for test systems« (page 53), “Archiving”.

Use this function to save the test process.

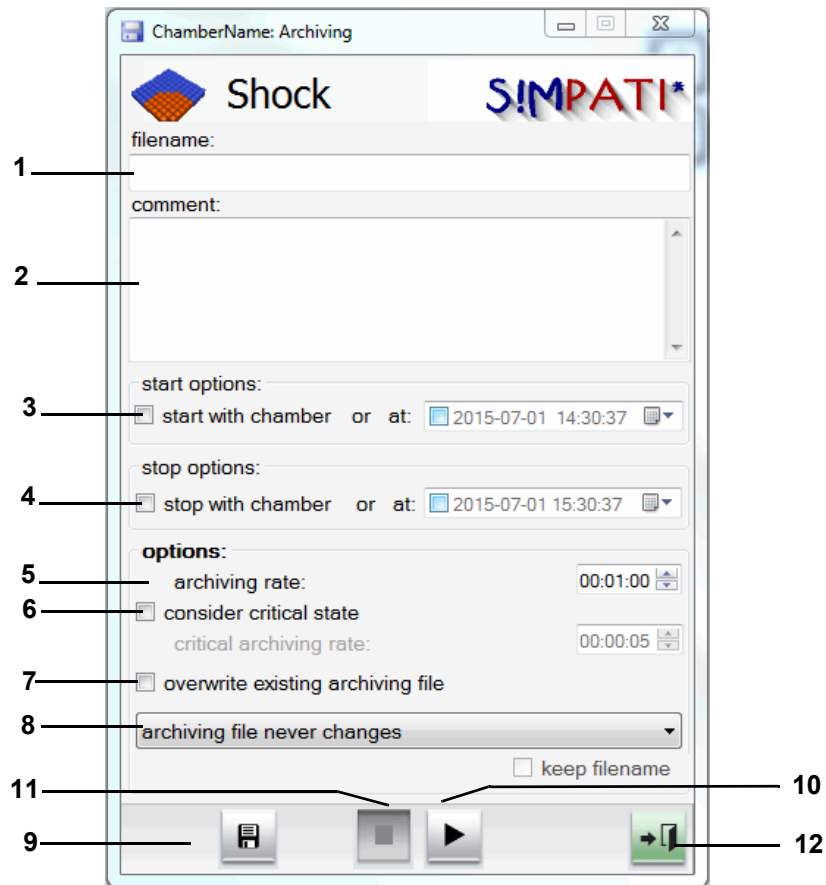

Fig. 11-1: Archiving

- 1 Archive name - if no archive name is input, an archive name will be automatically issued (current date).
- 2 Comments on recordings (appears in the graphic evaluation).
- 3 Time / date for starting the recording or the recording begins at the start of the test.
- 4 Time / date for stopping the recording or the recording stops at the end of the test or if the chamber malfunctions.
- 5 The status of the chamber is recorded at these intervals.
Since the archiving module in the standard version operates with a 5 second rhythm, only values of 5 sec or a multiple of 5 sec make sense.

-
- 6 You can define the intervals for the recording in the event of a malfunction, 5 sec or a multiple of 5 sec.
 - 7 You can activate this function and after that the existing file of the same name is automatically overwritten. This must be taken into account particularly if there are several tests on one day which are archived under that day's date.

The pharma variant does not provide this option.

- 8 Here you have the option of having a new archive file created for each new day, week or month. If the selection »Retain file name« is activated, the date is appended to the file name.
- 9 All inputs are saved.
- 10 Starts archiving immediately; the inputs for Item 3 are ignored.
- 11 Stops archiving immediately; the inputs for Item 4 are ignored.
- 12 Close the menu window; archiving will continue to run.

12 GRAPHIC ANALYSIS



Click on this icon on SIMPATI®'s main screen to run the “SimViewer” module for graphic analysis.

→ 5.1.1 »SIMPATI®'s main screen« (page 50)

“SimViewer” replaces the “SimKoord” and “VisuWin” modules. “SimKoord” will be supported up until SIMPATI® v4.80.

12.1 Graphic analysis screen – panels

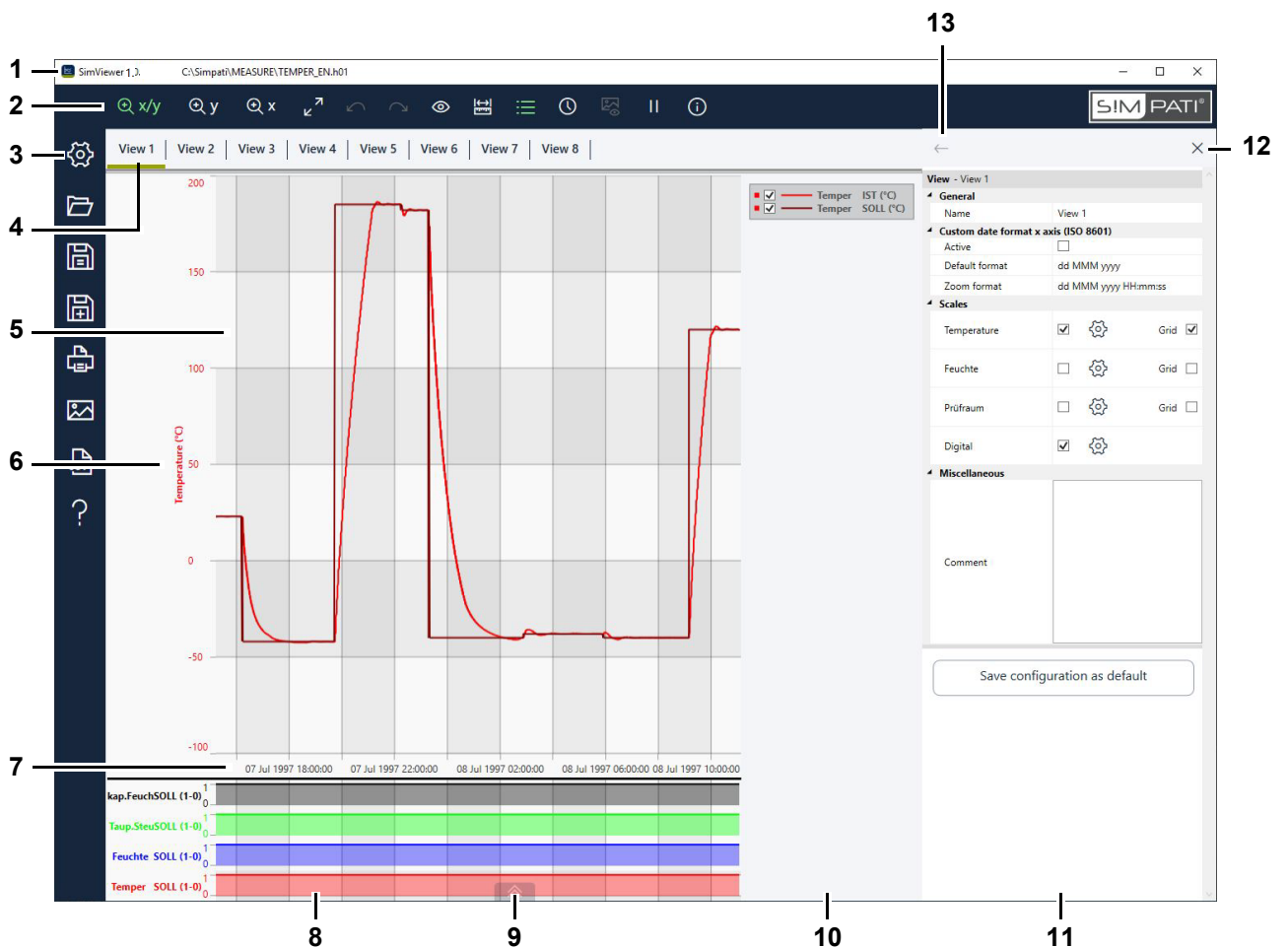

- 1 Program release as well as the directory and name of the measurement file displayed.
- 2 Header menu with tools for a graphic analysis of measured data.
→ 12.2 »Graphic analysis screen – header menu« (page 159)
- 3 Side menu with tools for configuring, loading, saving and exporting the views.
→ 12.3 »Graphic analysis screen – side menu« (page 160)
- 4 View 1...n tabs. You can define up to eight views.
→ 12.11 »View menu« (page 176)
- 5 View, i.e. a user-defined graphic representation of the data measured during a test.

Graphic analysis screen – panels

6 Scales of control variables. You can set up to three scales.

Double-clicking on a scale displays the “Axis” dialog where you can set the scale labels and value ranges and assign profiles to a scale.

→ 12.12 »Control variables axis menu« (page 178)

To view another value range, use the mouse to move the scale up or down.

7 Time axis.

Double-clicking on the time axis displays the “Time range” dialog where you can manually set an interval of the view or decide to show test data by days, weeks or months.

→ 12.8 »Time range menu« (page 171)

To view another interval, use the mouse to move the time axis to the left or right.

8 Digital channels.

Shows which digital channels were active at which time during the test (0 = OFF, 1 = ON).

Double-clicking on the name of a digital channel displays the “Axis” dialog where you can enable the display of digital channels as well as the channels to be displayed.

→ 12.13 »Digital channels axis menu« (page 180), “Active”

9 Show/hide the panorama view of the test. The panorama is a miniature representation of the profiles across the entire time of the test.

→ 12.5 »Panorama view of test process« (page 162)

10 Key to the control variables shown in the view. The legend may appear separately or as a part of the view.

→ 12.4 »Legend« (page 161)

11 Menu panel. The following menus are available.

→ 12.7 »Measurements menu« (page 168)

→ 12.8 »Time range menu« (page 171)

→ 12.9 »Show images menu« (page 173)

→ 12.10 »Info menu« (page 175)

→ 12.11 »View menu« (page 176)

→ 12.12 »Control variables axis menu« (page 178)

→ 12.13 »Digital channels axis menu« (page 180)

→ 12.14 »Export data menu« (page 181)

→ 12.15 »Help menu« (page 182)

Menus are accessed by clicking on the controls in the header or the side menu.

12 Close menu panel.

13 Show preceding menu.

Error messages are shown in a bubble. You may copy error details to the clipboard and send them to the Service Dept. via e-mail.

→ 12.16 »Error message« (page 183)



12.2 Graphic analysis screen – header menu

Use the tools in the header for a graphic analysis of the measured values.

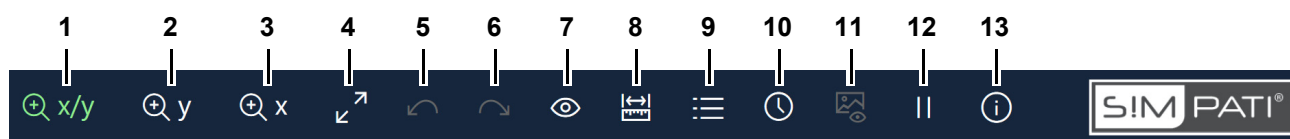

Fig. 12-2: Graphic analysis - header menu

- 1 Enable X/Y zoom mode (green marks the active mode).
→ 12.6 »Zoom function« (page 163)
- 2 Enable Y zoom mode.
- 3 Enable X zoom mode.
- 4 Undo all zooming and restore the original view.
Another method is to double-click on the view.
- 5 Undoes the last zoom step.
- 6 Redo the zoom step you just undid.
- 7 Show/hide the values of the control variables. The bar along the view defines the position on the time axis. It can be moved using the mousing.
- 8 Measure graph or perform an unrestricted measurement.
→ 12.7 »Measurements menu« (page 168)
- 9 Show key separately or as part of the view.
→ 12.4 »Legend« (page 161)
- 10 User-defined interval of the view or test data shown by days, weeks or months.
→ 12.8 »Time range menu« (page 171)
- 11 SIMPATI® TimeLabs Show images.
This function is available only if SIMPATI® TimeLabs took picture during the test.
→ 12.9 »Show images menu« (page 173)
- 12 Stop/resume monitoring.
This function is available only while the test system is busy and graphic analysis has been started from the context menu of the test system.
→ 5.1.3 »Context menu for test systems« (page 53), "Graphic analysis"
Monitoring shows a live view of the control variable profiles, which refreshes the profiles every time data is captured. When the profiles arrive at the right edge of the view, the measuring points will start inching to the left of the view to be able to display the most up-to-date measurements.
You can stop monitoring to measure a chart, for example. Data capture will continue in the background. When you resume monitoring, the view will be updated and return to showing the live data.
- 13 Show the software release and any comments entered while capturing data.
→ 12.10 »Info menu« (page 175)

12.3 Graphic analysis screen – side menu

Use the tools on the side menu to configure, load, save and export your views.

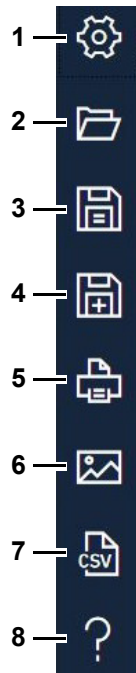

Fig. 12-3: Graphic analysis - side menu

- 1 Opens the view configuration screen.
→ 12.11 »View menu« (page 176)
- 2 Opens the measurement file and its views.
Another method is to use the mouse and drag the file from the file manager to the graphic analysis screen.



Best practice to obtain a good performance is to load the measurement data from a local drive.

- 3 Saves the views. Measured data will remain unchanged.
- 4 Saves the view under a new name. Measured data will remain unchanged.
- 5 Prints the view. The default orientation is landscape.
- 6 Saves the view as an image file.
- 7 Exports measured data of views to a CSV-format file.
→ 12.14 »Export data menu« (page 181)
- 8 Shows a list of keyboard shortcuts or opens the manual (PDF).
→ 12.15 »Help menu« (page 182)



When exporting to an image or CSV file, the system suggests to name the export file as the measurement file plus the name of the view.

12.4 Legend



Clicking on this icon displays the legend either separately or as part of the view..

	1	2	3	4	5
<input type="checkbox"/>	<input checked="" type="checkbox"/>		Temper	IST (°C)	
<input type="checkbox"/>	<input checked="" type="checkbox"/>		Temper	SOLL (°C)	
<input type="checkbox"/>	<input checked="" type="checkbox"/>		Feuchte	IST (%rf)	
<input type="checkbox"/>	<input checked="" type="checkbox"/>		Feuchte	SOLL (%rf)	
<input type="checkbox"/>	<input checked="" type="checkbox"/>		Prüfraum	IST	
<input type="checkbox"/>	<input checked="" type="checkbox"/>		Prüfraum	SOLL	

Fig. 12-4: Graphic analysis - legend

- 1 Colour of scale.
- 2 Show/hide profile in view.



Your choice of displayed/hidden profiles is lost when you go to another view.

- 3 Colour of profile.
- 4 Name of profile.
- 5 Physical unit of profile.

Panorama view of test process

12.5 Panorama view of test process



Click on this icon to show a panorama view of the test process.



Click on this icon to hide the panorama view of the test process.

Use the panorama view on long test processes to help you find your way around the measurement file and to set an interval for the view.

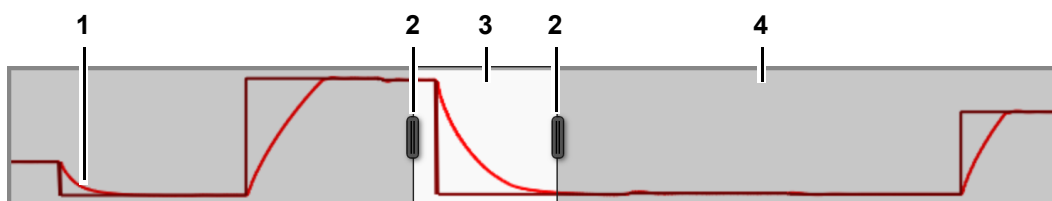

Fig. 12-5: Graphic analysis - panorama view of test process

- 1 Profiles.
- 2 Slide for zooming in/out of the interval displayed.
The view as such is refreshed instantly as you move the slide.
- 3 Section shown in the view.
- 4 Section not shown in the view (grey).

12.6 Zoom function

The following zoom modes are available for graphic analysis:

Zoom mode	Explanation
X	Zooms an interval to cover the entire width of the view.
Y	Zooms a range of values on the Y axis to cover the entire height of the view.
X/Y	Zooms a section of the view to cover the entire width and height of the view.

Tab. 12-1: Graphic analysis - zoom mode

12.6.1 Zoom controls



Fig. 12-6: Graphic analysis - header menu - zoom controls

- 1 Enable X/Y zoom mode (green marks the active mode).
Or: Press F6.
- 2 Enable Y zoom mode.
Or: Press F7.
- 3 Enable X zoom mode.
Or: Press F8.
- 4 Undo all zooming and restore the original view.
Another method is to double-click on the view.
- 5 Undoes the last zoom step.
- 6 Redo the zoom step you just undid.



There is no limit to how often you zoom in any of the modes.



Press Ctrl++ or Ctrl+- for inching the zoom factor in the current mode.

Zoom function

12.6.2 Zooming a view

Proceed as follows to zoom a view:

- »To zoom an X/Y section« (page 164)
- »To zoom a Y section« (page 165)
- »To zoom a X section« (page 166)
- »To zoom using the scroll wheel« (page 166)

To zoom an X/Y section

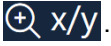
- ▶ Click on .
- ✓ The icon turns green, X/Y zoom mode has been enabled.
- ▶ Go to the view, click on a corner of the section you wish to zoom and keep the mouse button pressed.
- ▶ Drag the mouse until all of the section to be zoomed is within the rubber band frame.

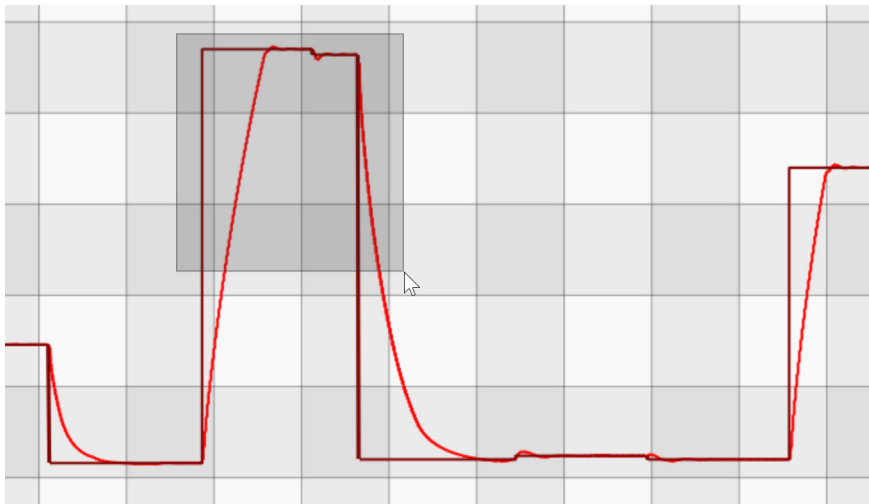



Fig. 12-7: Graphic analysis - zoom X/Y section

- ▶ Release the mouse button.
- ✓ The selected section is zoomed.



You can use any of the three zoom modes to further zoom the already zoomed section.

To zoom a Y section

- ▶ Click on .
- ✓ The icon turns green, Y zoom mode has been enabled.
- ▶ Go to the view, click on the height of the Y value from where you wish to zoom and keep the mouse button pressed.
- ▶ Drag the mouse until all of the section to be zoomed is within the rubber band frame.

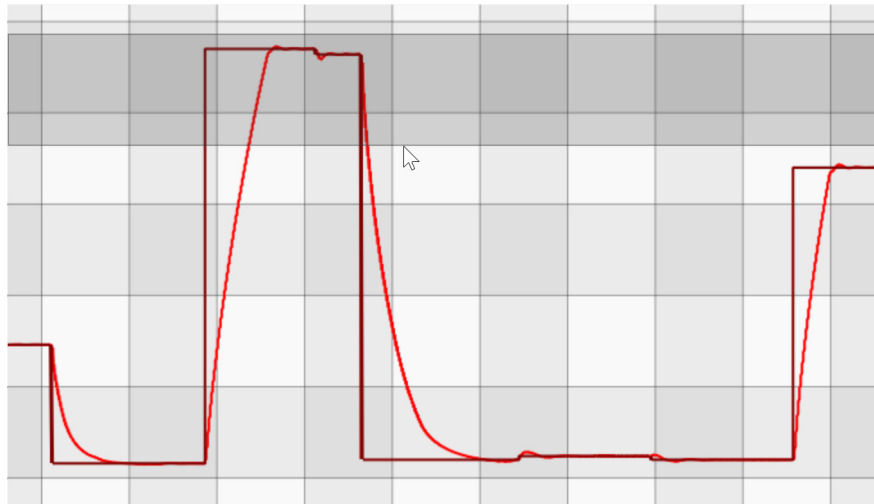

Fig. 12-8: Graphic analysis - zoom Y section

- ▶ Release the mouse button.
- ✓ The selected section is zoomed.



You can use any of the three zoom modes to further zoom the already zoomed section.

Zoom function

To zoom a X section

- ▶ Click on .
- ✓ The icon turns green, X zoom mode has been enabled.
- ▶ Go to the view, click on the value on the X axis from where you wish to zoom and keep the mouse button pressed.
- ▶ Drag the mouse until all of the section to be zoomed is within the rubber band frame.

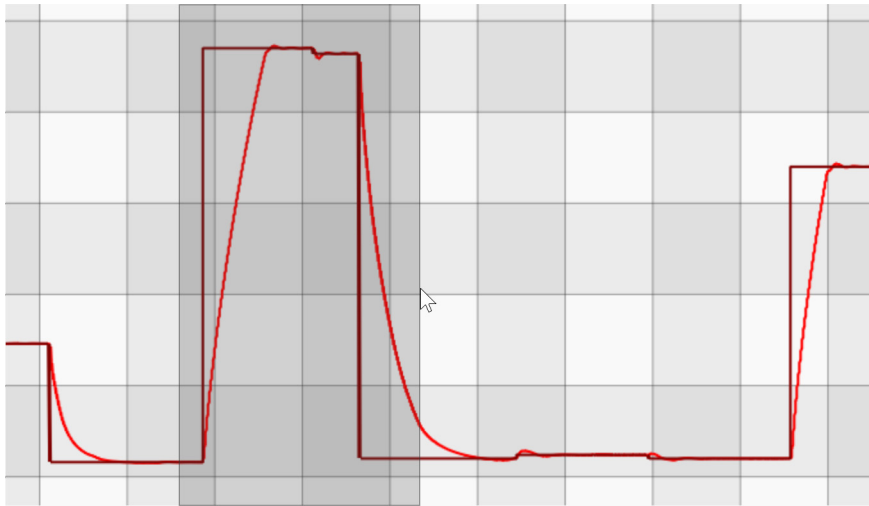

Fig. 12-9: Graphic analysis - zoom X section

- ▶ Release the mouse button.
- ✓ The selected section is zoomed.



Another method is to drag the time axis to the left or right using the mouse.

To zoom using the scroll wheel

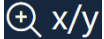
- ▶ Choose one of the zoom modes, e.g. .
- ▶ Go to the view and place the mouse pointer to where you wish the zoom focus to be.
- ▶ Turn the scroll wheel.
- ✓ This will continuously zoom the view while keeping the mouse pointer at the centre.



Zooming will move along the X or Y or both axes, depending on the zoom mode you selected.

12.6.3 Moving the zoom section

Proceed as follows to move a zoom section:

To move a zoom section in any direction

- ▶ Place the mouse pointer on the view.
- ▶ Press and hold the right mouse button.
- ▶ Move the mouse pointer across the view.
- ✓ The zoomed section can be moved in any direction. The size of the zoom window is retained.

To move a zoom section in the X direction

- ▶ Press and hold the shift key.
- ▶ Turn the scroll wheel.
- ✓ The zoomed section moves in the X direction. The size of the zoom window is retained.

To move a zoom section in the Y direction

- ▶ Press and hold the Ctrl key.
- ▶ Turn the scroll wheel.
- ✓ The zoomed section moves in the Y direction. The size of the zoom window is retained.

Measurements menu

12.7 Measurements menu



Click on this icon to measure two point on a graph and to perform a free measurement.

A free measurement is not limited by profiles.

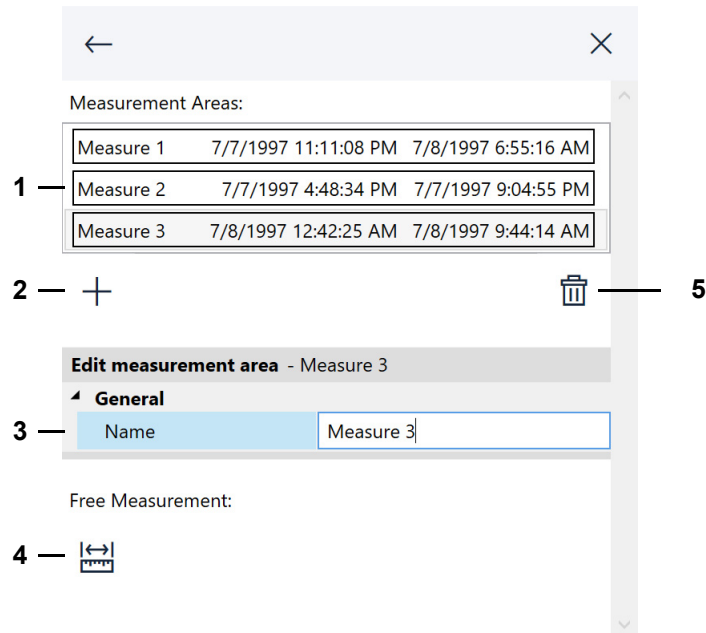



Fig. 12-10: Graphic analysis - measurements menu

- 1 List of points on graphs measured.
- 2 Measure graph.
→ »To measure a graph« (page 169)
- 3 Name a graph measurement. By default, measurements are numbered consecutively by view.
- 4 Perform a free measurement.
→ »To perform a free measurement« (page 170)
- 5 Delete the measurement selected on the list (item 1).



Points on graphs measured are saved with the view, whereas free measurements are not saved.

To measure a graph

- ▶ Click on .
- ✓ The measurements menu pops up.
- ▶ Click on .
- ✓ The icon turns green.
- ▶ Go to the view and click on the graph you wish to measure.
- ✓ The graph shows as a bold line.
- ▶ Click on the starting point on the graph.
- ▶ Click on the end point on the graph.
- ✓ The coordinates of both points (X1|Y1) and (X2|Y2), their distance ($\Delta x, \Delta y$) and the inclination per minute ($\Delta y/\text{min}$) are displayed.





To change the measuring interval, drag the bars at the interval borders with the mouse.

- ▶ Enter a descriptive name of the measurement in the box next to “Name”.

Measurements menu

To perform a free measurement

- ▶ Click on .
- ✓ The measurements menu pops up.
- ▶ Click on .
- ✓ The icon turns green.
- ▶ Go to the view, click on the starting point of measuring and keep the mouse button pressed.
- ▶ Move the mouse pointer to the end point of your free measurement and release the mouse button.
- ✓ The coordinates of points, their distance and the inclination per minute are displayed.

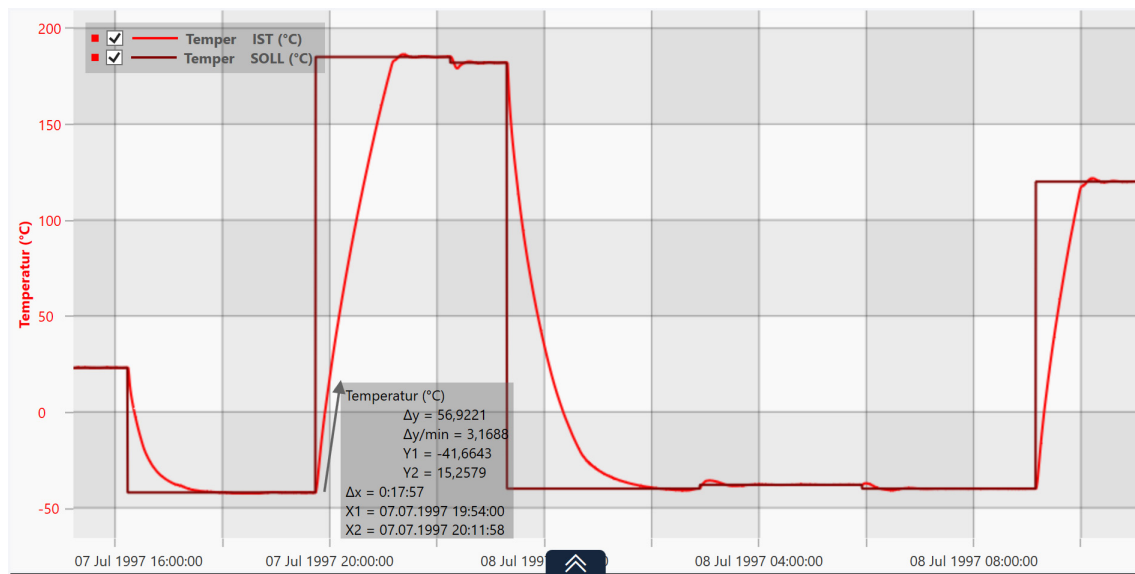

Fig. 12-11: Graphic analysis - free measurement



If a view has several scales, the coordinates of points, their distance and the inclination per minute are displayed for every scale.

If you move the scale with the mouse, the free measurement values will adapt.

12.8 Time range menu



Click on this icon to manually set an interval of the view or decide to show test data by days, weeks or months.

The menu lets you view and analyse long test processes.

On the “Customized Time Range” panel, you can manually define the interval to be shown in the view.

On the “Time Range” panel, you can set the interval to a whole day, a whole week or a whole month. On the “Move” Panel, you can then move the test data by day, week or month, depending on how long the test process is.

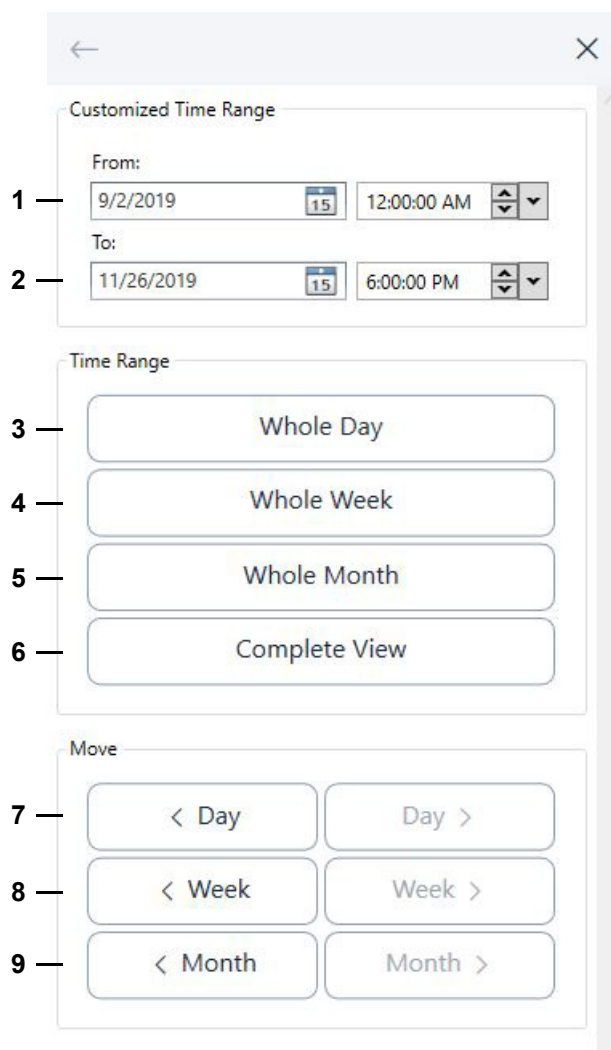

Fig. 12-12: Graphic analysis - time range menu

- 1 Start of customised time range.

Enter the date in the box or pick it from the calendar.

Then proceed to entering the time. Or you may highlight the hour, minutes or seconds and use the arrow buttons to increase or decrease them. The dropdown list on the right lets you set the time to the full hour.

Time range menu

Remember to press Enter every time you enter or select a date or time.

2 End of customised time range.

For entering the date and time, see (item 1).

3 Click to display whole days.

4 Click to display whole weeks.

5 Click to display whole months.

6 Restore original view.

7 Move the view a whole day forward or backward.

8 Move the view a whole week forward or backward.

9 Move the view a whole month forward or backward.



Moving the view a day, week or month forward or backward will work only if you set the appropriate interval on the “Time Range” panel.



While data is being captured (monitoring), a customised time range will change automatically to ensure that you will see the most recent measurements.

12.9 Show images menu



Click on this icon to show the images SIMPATI® TimeLabs took while testing was in progress.

The icon turns green when the image view has been enabled. Click on the icon again to close the image view.

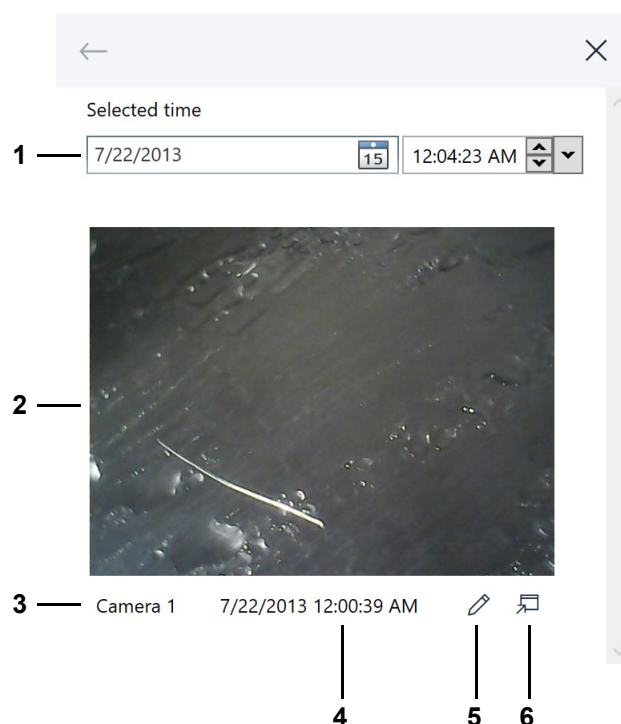

Fig. 12-13: Graphic analysis - show images menu

- 1 Select the time a SIMPATI® TimeLabs image is to be shown for.

Enter the date in the box or pick it from the calendar.

Then proceed to entering the time. Or you may highlight the hour, minutes or seconds and use the arrow buttons to increase or decrease them. The dropdown list on the right lets you set the time to the full hour.

Remember to press Enter every time you enter or select a date or time.

Or use the vertical bar in the view to select a time.



SIMPATI® TimeLabs takes pictures at regular intervals. The view displays the picture last taken before the set time.

- 2 SIMPATI® TimeLabs picture.
- 3 Name of camera. SIMPATI® TimeLabs supports up to six cameras.
- 4 Time the SIMPATI® TimeLabs picture was taken.

Show images menu

- 5 Run the default image editor to open the SIMPATI® TimeLabs picture to document events during the test process by pictures, for example.



Attention: The image editor shows the original file. Deleting the file also deletes the picture.

- 6 Open the SIMPATI® TimeLabs into a separate window to output it to a second screen, for example. The picture will be the same as that on the menu.

12.10 Info menu



Click on this icon to display the software release and any comments entered while capturing data.

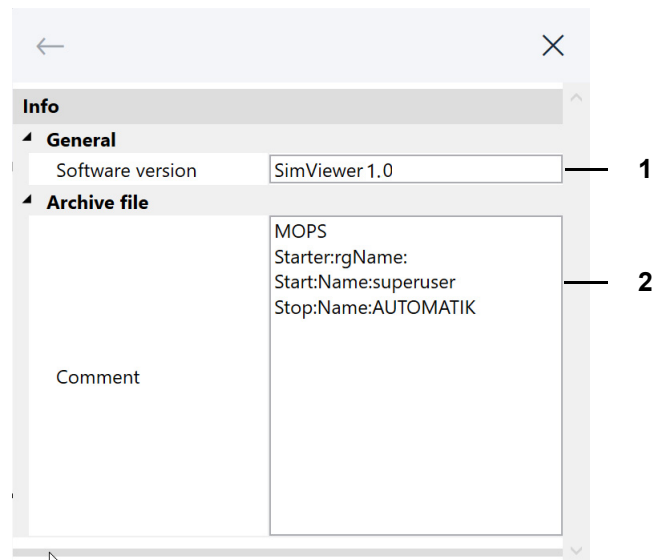

Fig. 12-14: Graphic analysis - info menu

- 1 Software module for graphic analysis.
- 2 Comments entered while capturing test data:
→ 11 »Archiving« (page 155).

View menu

12.11 View menu



Click on this icon to set up a view.

A view is a user-defined graphic representation of the data measured during a test. You can set up eight different views.

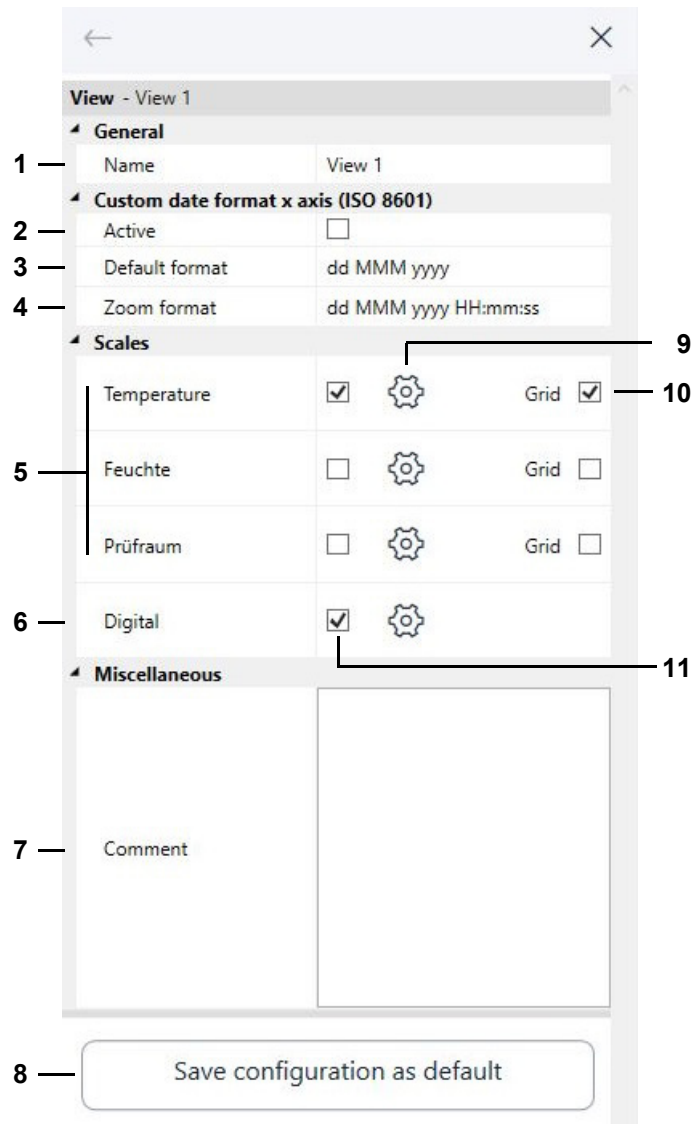

Fig. 12-15: Graphic analysis - view menu

- 1 Name of view. The name appears on the tab of that view.
→ 12.1 »Graphic analysis screen – panels« (page 157)
- 2 Enable the custom date formats of the time axis (items 3 and 4).
The standard date formats of ISO 8601:2004 will be used for as long as your custom date formats have not been enabled.
- 3 Define a custom standard format of the time axis.
Use the letters to define a date and time format.
- 4 Define a custom zoom format of the time axis.
The zoom format is used to zoom the view intervals less than a day long. Use the letters to define

- a date and time format.
- 5 Show/hide the scales of the control variables.
Up to three scales can be shown in the view.
 - 6 Show/hide digital channels.
 - 7 Comment on the view.
You can enter a separate comment for every view.
 - 8 Save the current configuration of the view as the default of future archive files.
 - 9 Configure the scale or choose digital channels to be displayed.
→ 12.12 »Control variables axis menu« (page 178)
→ 12.13 »Digital channels axis menu« (page 180)
 - 10 Show horizontal gridlines for the scale concerned.
You can show a separate grid for every scale. Gridlines will move along with the scale when you move the scale up or down using the mouse.
 - 11 Show/hide scale/digital channels on the view.

When selecting another view, double-click on its tab to output the details of the new view to the "View" menu.



Single-clicking to change views will not refresh the "View" menu.

To refresh the menu nevertheless, click on .

Control variables axis menu

12.12 Control variables axis menu



Click on this icon next to a scale on the “View” menu to define the labels and the value range of a scale and to assign profiles to the scale.

→ 12.11 »View menu« (page 176)

Or double-click on a scale in the view.

1 — Axis - View 1: Temper

2 — **General**

3 — Active

4 — Name Temper

5 — Unit °C

6 — Color ■ Red

7 — Grid lines

8 — **Zoom Limits**

9 — Min. value -100

10 — Max. value 200

11 — **Visible Range**

12 — Min. value -100

Max. value 200

Available Profiles:

9 —

10 — Add to scale

Assigned Profiles:

11 — (AV) Temper IST (°C)

(SP) Temper SOLL (°C)

12 — Remove from scale

Fig. 12-16: Graphic analysis - control variables axis menu

- 1 Names of the view and the scale.
- 2 Show/hide scale on the view.
- 3 Physical unit of control variable shown together with the names of the scale (item 4) as scale label.
- 4 Name of scale.
- 5 Colour of scale.
- 6 Show horizontal gridlines for the scale. Gridlines will move along with the scale when you move the scale up or down using the mouse.
- 7 Value range of the scale that will be restored when undoing a zoom process.

- 8 Value range of the scale initially shown in the view.
The value range in the view changes as you zoom or scroll the scale.
- 9 Profiles you can assign to the scale.
- 10 Control to click on to assign an available profile to a scale. Remember to first of all select the profile on the list (item 7).
Or just double-click on the profile.
- 11 Profiles assigned to the scale.
Upon selecting a profile, menu panel *Edit Profile* displays to let you choose the colour for the profile displayed.
- 12 Control to click on to remove a profile from the scale. Remember to first of all select the profile on the list (item 9).
Or just double-click on the profile.

Proceed as follows to select and assign/remove several profiles at once:



- Select a profile, press and hold the shift key, then select another profile: This will select all profiles between the two profiles you selected first.
 - Select a profile, press and hold the Ctrl key, then select other profiles: This will select all profiles you click on.
-

Digital channels axis menu

12.13 Digital channels axis menu



Click on this icon next to the digital channels shown on the “View” menu to select the digital channel to be displayed.

→ 12.11 »View menu« (page 176)

Or double-click on the name of a digital channel in the view.

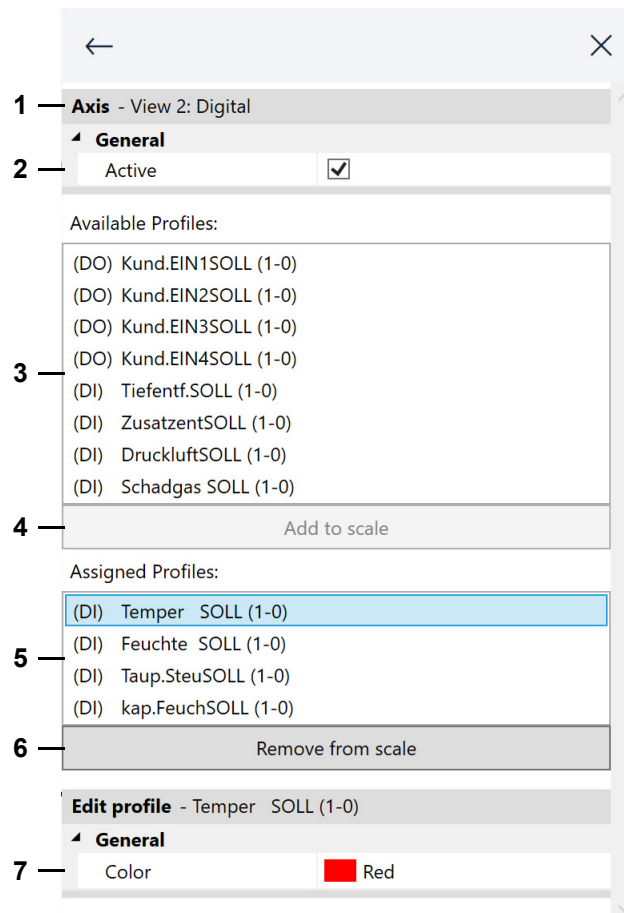

Fig. 12-17: Graphic analysis - digital channels axis menu

- 1 Name of view.
- 2 Show/hide digital channels on the view.
- 3 Digital channels you can assign to the view.
- 4 Control to click on to assign an available digital channel to the view. Remember to first of all select the digital channel on the list (item 3).
Or just double-click on the digital channel.
- 5 Digital channels assigned to the view.
- 6 Control to click on to remove a digital channel from the view. Remember to first of all select the digital channel on the list (item 5).
Or just double-click on the digital channel.
- 7 Select a colour to mark a digital channel. Remember to select the digital channel on the list (item 5).

12.14 Export data menu



Click on this icon to set delimiters for the measured data displayed in a view and export the data to a CSV file.

You can afterwards open and further analyse the exported data using Excel or any other suitable application.

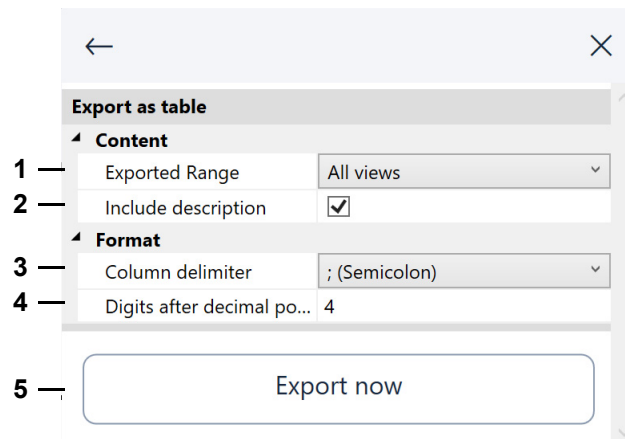

Fig. 12-18: Graphic analysis - export data menu

- 1 Say to export just the current or all views.
- 2 Say whether to export the meta data.
Ticking this option will add the serial number of your SIMPATI® licence, the name of the test system, the export date etc. to the export file.
- 3 Select a character to delimit every piece of measured information.
- 4 Set the number of decimal places the measured data will be exported with.
- 5 Start the export process.

Help menu

12.15 Help menu



Click on this icon to show a list of keyboard shortcuts or to load the manual.

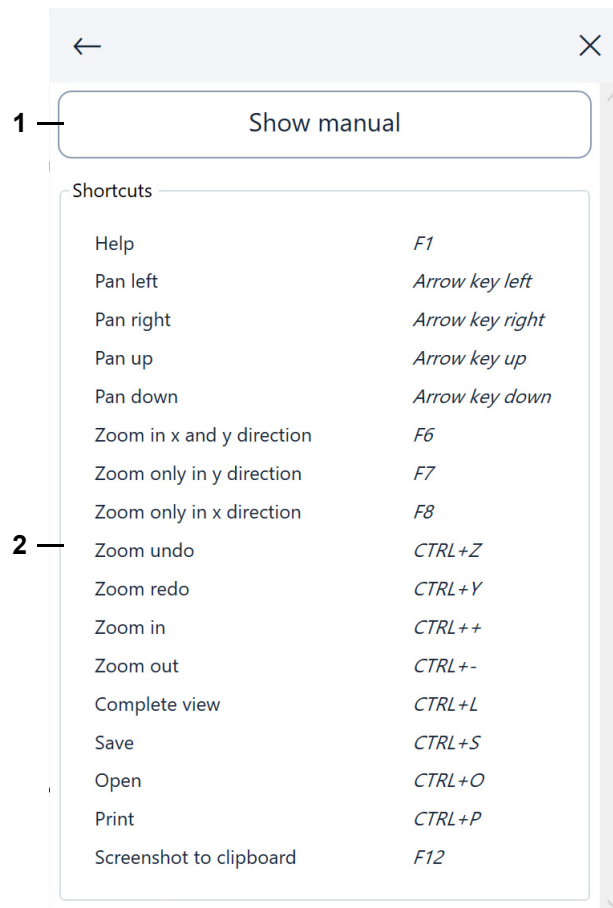

Fig. 12-19: Graphic analysis - help menu

- 1 Click to load the manual (PDF).
- 2 List of keyboard shortcuts.

12.16 Error message

You will see the following prompt whenever an error occurs.

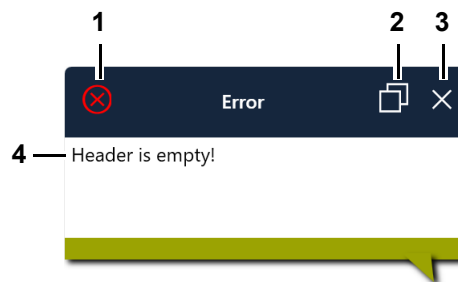

Fig. 12-20: Graphic analysis - error message

- 1 Severity of the error message, e.g. red = command cannot be executed.
- 2 Copy details of the error message to the clipboard.

You may paste the details from the clipboard in an e-mail and send it to the Service Dept. to report a more detailed context of the error.

- 3 Close the error prompt.
- 4 Error message text.

Error message

13 CHAMBER REPORTS AND MESSAGES (SIMREPORT)

Use SIMPATI®'s main screen to access this menu.

→ 5.1.1 »SIMPATI®'s main screen« (page 50)

Run »SimReport« to display reports and messages of the test systems. Reports and messages can be filtered by various criteria.

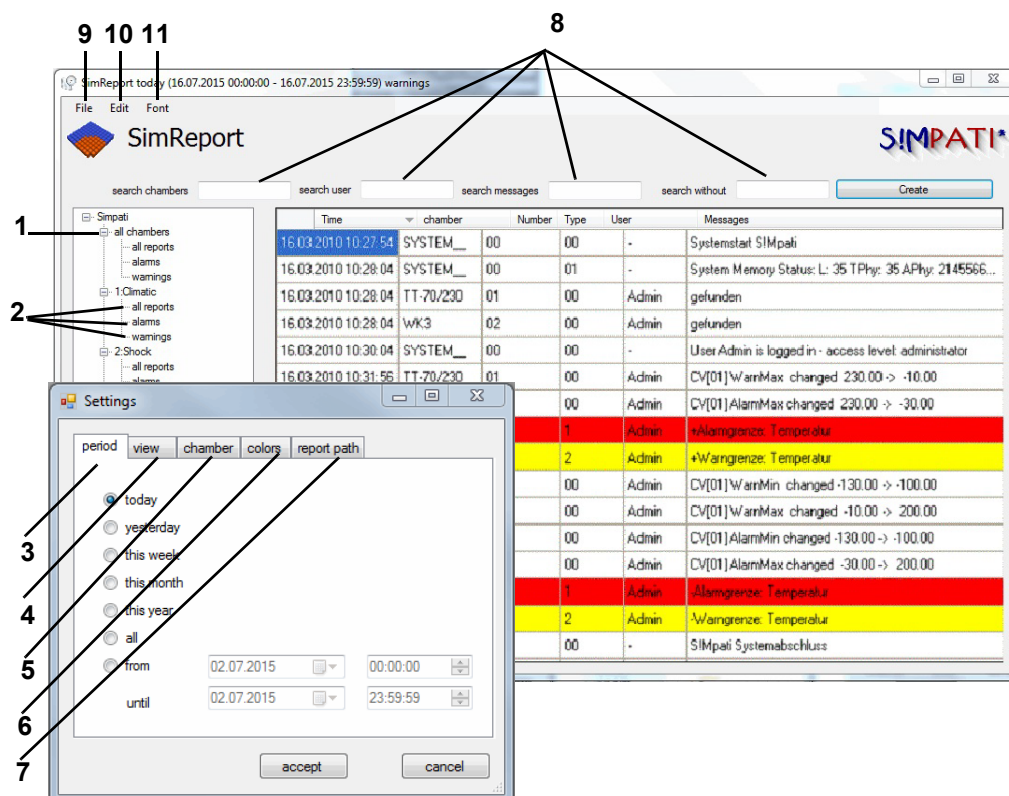

Fig. 13-1: SimReport

- 1 Show the messages and reports of all or single chambers.
- 2 You can pick the following details of every chamber:
 - All report entries.
 - Alarms only.
 - Warnings only.
- 3 Filter by creation date.
Opens the “Edit” menu (item 10) to display the “Settings” dialog.
- 4 Filter by message type.
- 5 Filter by chamber.
- 6 Select colours for the message types.
- 7 Set the path to the report file.
- 8 Filter messages by: chamber, user and messages. Or exclude particular messages by filtering.
- 9 Print messages, export to PDF or exit the application.
- 10 Open the “Settings” dialog.
- 11 Select a font for the messages.

Zeit	Kammer	Nummer	Typ	Benutzer	Meldung
05.03.2010 08:15:30	SYSTEM_	00	00	-	SIMPati Systemabschluss
05.03.2010 08:16:07	SYSTEM_	00	00	-	Systemstart SIMpati
05.03.2010 08:16:17	SYSTEM_	00	01	-	System Memory Status: L: 37 TPhy: 35 APhy: 2145566720
05.03.2010 08:16:17	TT-70/230	01	00	Admin	gefunden
05.03.2010 08:16:17	WK3	02	00	Admin	gefunden
05.03.2010 08:16:17	SYSTEM_	00	00	-	User Admin is logged in - access level: administrator
05.03.2010 08:22:46	SYSTEM_	00	00	-	SIMPati Systemabschluss
08.03.2010 08:17:20	SYSTEM_	00	00	-	Systemstart SIMpati
08.03.2010 08:17:31	SYSTEM_	00	01	-	System Memory Status: L: 39 TPhy: 38 APhy: 2145566720
08.03.2010 08:17:31	TT-70/230	01	00	Admin	gefunden
08.03.2010 08:17:31	WK3	02	00	Admin	gefunden
08.03.2010 08:17:40	SYSTEM_	00	00	-	User Admin is logged in - access level: administrator
08.03.2010 08:52:01	SYSTEM_	00	00	-	SIMPati Systemabschluss
08.03.2010 11:08:30	SYSTEM_	00	00	-	Systemstart SIMpati
08.03.2010 11:08:40	SYSTEM_	00	01	-	System Memory Status: L: 43 TPhy: 41 APhy: 2145566720
08.03.2010 11:08:40	TT-70/230	01	00	Admin	gefunden
08.03.2010 11:08:40	WK3	02	00	Admin	gefunden
08.03.2010 11:08:41	SYSTEM_	00	00	-	User Admin is logged in - access level: administrator
08.03.2010 11:13:10	SYSTEM_	00	00	-	SIMPati Systemabschluss
12.03.2010 10:05:30	SYSTEM_	00	00	-	Systemstart SIMpati
12.03.2010 10:05:40	SYSTEM_	00	01	-	System Memory Status: L: 27 TPhy: 26 APhy: 2145566720
12.03.2010 10:05:40	TT-70/230	01	00	Admin	gefunden
12.03.2010 10:05:40	WK3	02	00	Admin	gefunden
12.03.2010 10:05:55	SYSTEM_	00	00	-	User Admin is logged in - access level: administrator
12.03.2010 10:31:24	TT-70/230	01	02	Admin	Admin : Stop Simulationsprg.TestScheduler
12.03.2010 10:31:51	SYSTEM_	00	00	-	SIMPati Systemabschluss
16.03.2010 10:27:54	SYSTEM_	00	00	-	Systemstart SIMpati
16.03.2010 10:28:04	SYSTEM_	00	01	-	System Memory Status: L: 35 TPhy: 35 APhy: 2145566720
16.03.2010 10:28:04	TT-70/230	01	00	Admin	gefunden
16.03.2010 10:28:04	WK3	02	00	Admin	gefunden
16.03.2010 10:30:04	SYSTEM_	00	00	-	User Admin is logged in - access level: administrator
16.03.2010 10:31:56	TT-70/230	01	00	Admin	CV[01] WarnMax changed 230.00 -> -10.00
16.03.2010 10:31:56	TT-70/230	01	00	Admin	CV[01] AlarmMax changed 230.00 -> -30.00
16.03.2010 10:32:05	TT-70/230	01	1	Admin	+Alarngrenze: Temperatur
16.03.2010 10:32:05	TT-70/230	01	2	Admin	+Warngrenze: Temperatur
16.03.2010 10:32:34	TT-70/230	01	00	Admin	CV[01] WarnMin changed -130.00 -> -100.00
16.03.2010 10:32:34	TT-70/230	01	00	Admin	CV[01] WarnMax changed -10.00 -> 200.00
16.03.2010 10:32:34	TT-70/230	01	00	Admin	CV[01] AlarmMin changed -130.00 -> -100.00
16.03.2010 10:32:34	TT-70/230	01	00	Admin	CV[01] AlarmMax changed -30.00 -> 200.00
16.03.2010 10:32:35	TT-70/230	01	1	Admin	-Alarngrenze: Temperatur
16.03.2010 10:32:35	TT-70/230	01	2	Admin	-Warngrenze: Temperatur
16.03.2010 10:43:11	SYSTEM_	00	00	-	SIMPati Systemabschluss

Page 10 of 11

Fig. 13-2: Export report to a PDF file.

14 AUTOMATIC GENERATION OF E-MAIL MESSAGES IN SIMPATI®

SIMPATI® continuously monitors the error states of all linked-in chambers. If a change in status is detected, the corresponding error message or other messages can be sent as an e-mail to any valid e-mail address.

To start SimMailer when SIMPATI® is started, the following entry must be made in start file `simpati.str`.

98:01:simmailer::

For automatic activation, refer to:

→ 14.4.1 »Autostart when launching SIMPATI®« (page 192)

SimMailer is opened in the taskbar with the right mouse button and "Show" or a double-click. The SimMailer can also be called up via an icon in the main menu → 5.1.1 »SIMPATI®'s main screen« (page 50) → 11 (page 51).



Fig. 14-1: SimMailer

1 SimMailer.

- ▶ If Simpati is installed as a service, click on desktop icon "SimMailer SIMPATI (Service)" to open the SimMailer interface.

14.1 Prerequisites

SMTP server.



The SMTP server is not a part of the SIMPATI® software.

Setting up messages

14.2 Setting up messages

To set up the messages, you need to be logged in to SIMPATI® and own the appropriate SIMPATI® user rights. The messages that should be sent, the chamber from which they should be sent and the recipients to whom they should be sent can be configured via different profiles. A profile is composed of a message list (2) and a recipient list (4).

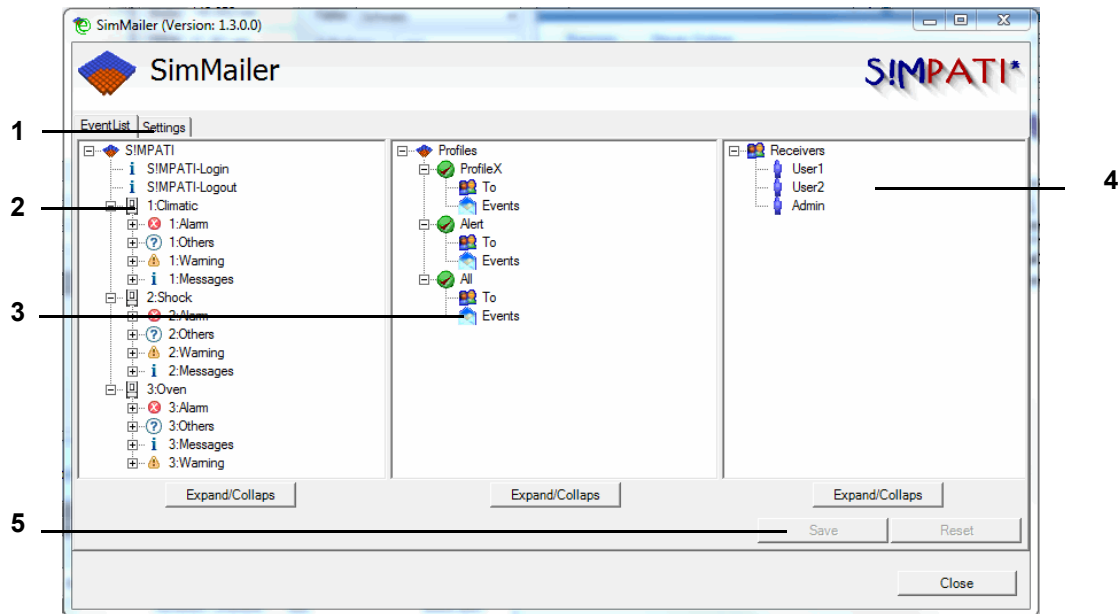

Fig. 14-2: SimMailer base menu

- 1 Settings → 14.3 »General settings« (page 191)
- 2 List of messages: select chambers and type of message.
- 3 Here, profiles can be created and configured and which messages are to be sent to which recipients.
- 4 List of recipients: select recipients.
- 5 »Übernehmen« or »Reset« your changes.



Profile features are applied by dragging and dropping the relevant messages and users into the profile.

14.2.1 Setting up profiles

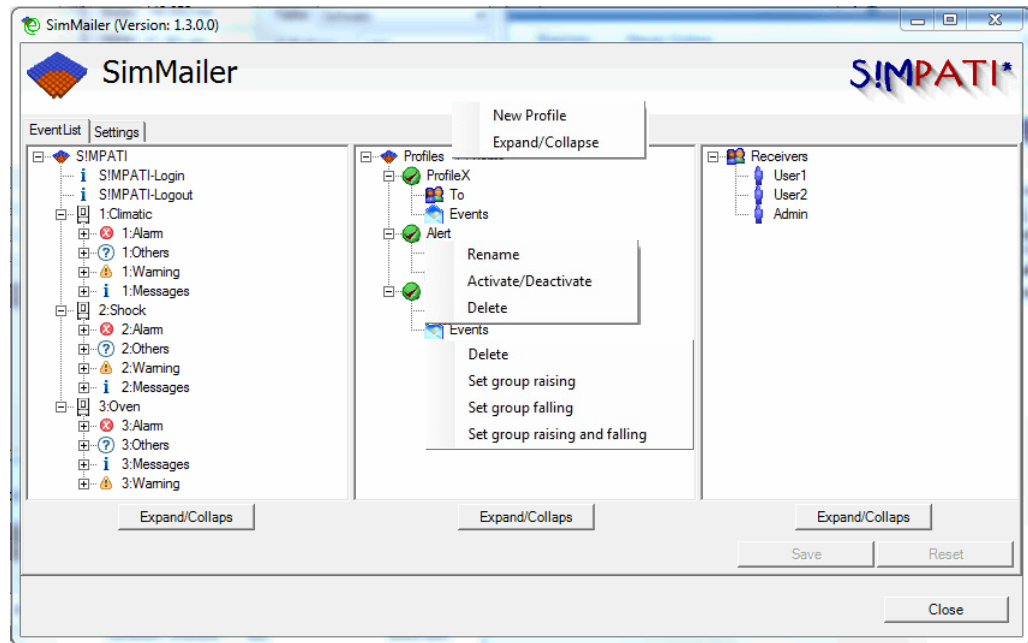

Fig. 14-3: Setting up events

The events can be configured in groups or individually.

- | | |
|-----------------------|----------------------------------|
| incoming | Only incoming messages are sent. |
| outgoing | Only outgoing messages are sent. |
| incoming and outgoing | All messages are sent. |

New profiles can be created and deleted; individual profiles can be activated and deactivated. If a profile is deactivated, no messages are sent to this profile.

Setting up messages

14.2.2 Setting up recipients

New users can be added by right-clicking on »Recipient«.

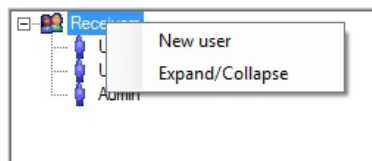

Fig. 14-4: Setting up recipients

The settings for the recipient can be opened by right-clicking on the particular user.

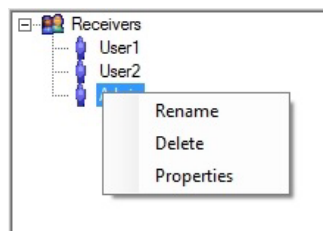

Fig. 14-5: Settings Recipient

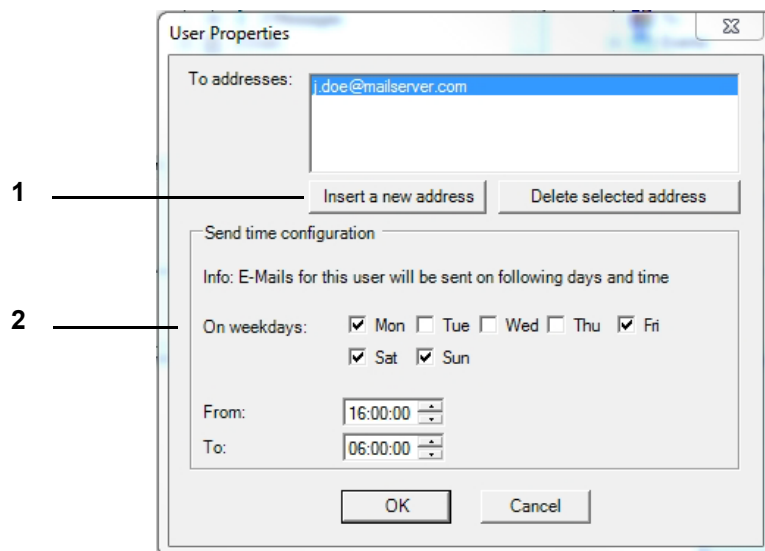

Fig. 14-6: Setting up an e-mail address

- 1 Enter email address.
A recipient may have one or several addresses.
- 2 Set the reception time, i.e. on which days and at what times messages will be sent to the above e-mail addresses.

14.3 General settings

The basic settings for the SMTP server and general message features are set via this menu.

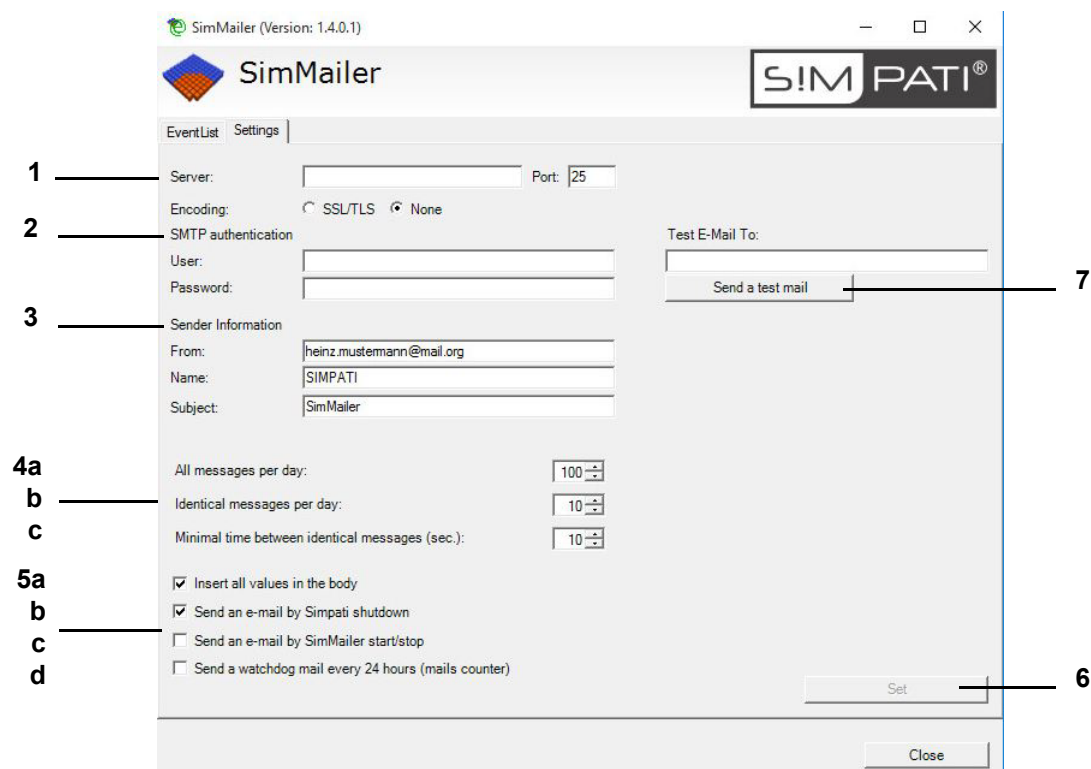

Fig. 14-7: Configuring mail settings

- 1 Server: Name or IP address of SMTP server.
Port: Port to be used for sending e-mails.
Encoding: Send e-mails over an encrypted network connection (SSL connection).
- 2 SMTP: Authentication; do not fill in these fields if the server does not require authentication.
- 3 Sender information: Sender's e-mail address, user name and subject.
- 4 Set the frequency of messages.
 - a: Number of messages per day.
To avoid overloading the server, you can set a maximum number of messages within a 24 hour period.
 - b: Number of identical messages within 24 hours (max.)
Messages recurring within 24 hours will not be sent more often than set in this box.
 - c: Time between identical messages (sec)
Time to be left between identical messages; messages sent within that period will be ignored.
- 5 Select other types of messages.
 - a: Include all values in body.
Sends the current status of values of the chamber selected.
 - b: Send e-mail when exiting SIMPATI®.
An e-mail is sent upon exiting SIMPATI®.
 - c: Send e-mail when starting/stopping SimMailer.
An e-mail is sent upon starting or stopping SimMailer.

Starting/stopping SimMailer

- d: Send watchdog e-mail every 24 hours.
Every 24 hours, all active users are sent a collective message with the total number of e-mails sent.
- 6 The settings are saved by clicking on »Accept«.
- 7 The SMTP configuration can be tested via »Send test report«.

14.4 Starting/stopping SimMailer

In order for emails to be sent via the SimMailer, it must be activated in the taskbar with the right mouse button and "Start Mailer". If SimMailer is activated, the symbol in the taskbar appears in green.

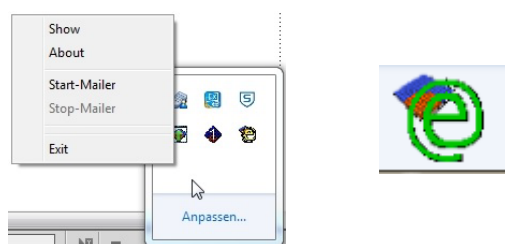

Fig. 14-8: Starting/stopping SimMailer

14.4.1 Autostart when launching SIMPATI®

Add the entry below to start file simpati.str if you wish to automatically enable all set-up profiles upon launching SIMPATI®.

```
98:01:simmailer:-start:
```

15 FAULTS, WARNING/ALARM/ERROR MESSAGES

Use the chamber's context menu to access the page displaying the warning/alarm/error messages.

→ 5.1.3 »Context menu for test systems« (page 53), "Configuration" → "Show errors/warnings".

15.1 Showing the list of warning/alarm/error messages

Use the chamber's context menu or EBO to access this menu.

→ 5.1.3 »Context menu for test systems« (page 53), "Configuration" → "Show errors/warnings".

You can choose between two lists of messages:

- All current warning/alarm/error messages (→ Fig.).
- All messages set for the chamber concerned.

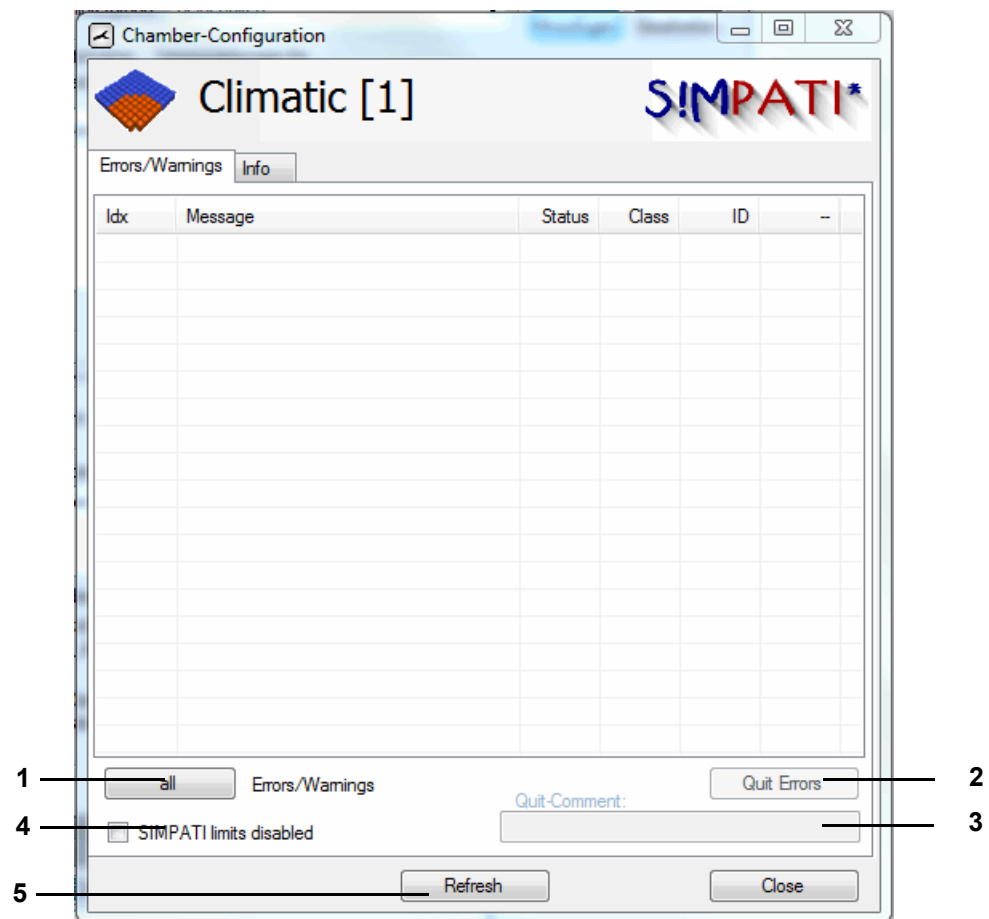

Fig. 15-1: Display current warning/alarm/error messages

Showing the list of warning/alarm/error messages

- 1 This control toggles between the lists of messages.
Current messages are highlighted in the list of all warning/alarm/error messages set for the chamber concerned.
- 2 All current messages are acknowledged but not deleted; they appear in the overall list of messages.
- 3 Comment on acknowledging the errors in the overall list of messages.
- 4 Tick this box to disable the S!MPATI® limits of warnings and alarms. You can tick this box only if you have the right to "Change alarms/warnings".

i If S!MPATI® limits are disabled (box is ticked), entries for warning and alarm reports are not generated. System faults continue to be monitored.

In the pharma variant, this box is unticked.

→ *Appendix: »Installation for operation in pharmaceutical environments« (page 243)*

- 5 Refresh view.

i Error messages that emanate from the chamber controller are described in the operating manual for the chamber.

- ▶ Acknowledge messages originating in the chamber once the cause is corrected, first on the chamber and then in S!MPATI®.
-

APPENDIX: CHAMBER CONTROLLER SETUP

A: 1 CHAMBERS WITH MOPS, CTC OR TC CONTROLLERS

At the terminal, make the following settings before starting the configuration program:

E4 terminal (chapter 3.5 of the terminal operating manual)

Interface protocol OP 0	Select: 4 (TSI protocol)
Interface type OP 2	Select: 0 (RS 232)
Address selection OP 3	Select: 0 to 31 - the address number in the terminal is 1 digit smaller than the address number in SIMPATI®.

C terminal (chapter 3.2 of the terminal operating manual)

Interface protocol type	Select: External TSI (ISAR controller: transparent)
Interface type	Select: RS 232
Baud rate	Select: 9600
Address selection	Select: 0 to 31 - the address number in the terminal is 1 digit smaller than the address number in SIMPATI®.

A: 2 CHAMBERS WITH DMR CONTROLLER

At the terminal, make the following settings before starting the configuration program:

Base control panel	(→ chapter »Open and closed loop control« in the operating manual of the relevant chamber)
Address	1 . . . 9 (version 38 and earlier) 1 . . . 32 (version 39 and later)
Baud rate	9600 baud
The address is the same as in SIMPATI®.	

A: 3 CHAMBERS WITH MINCON / SIMCON CONTROLLER

SIMPATI® supports the JBus protocol of this controller with a transfer rate of 19200 baud. Valid addresses are 1 to 32.



To check the settings of the interface parameters, press the following in the basic menu. The following menu appears:

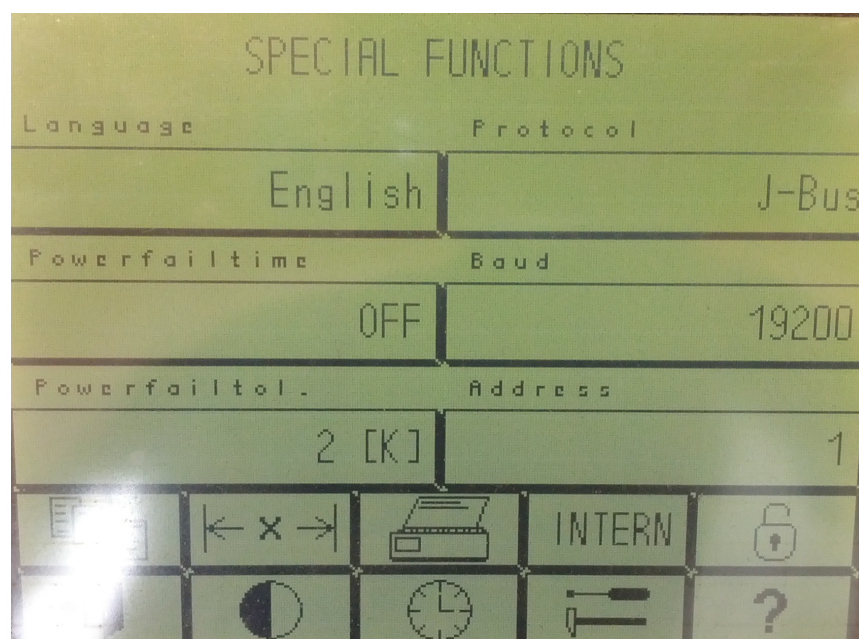

Fig. 3-1: Special functions

Chambers will be effective after restarting the chamber.

Configuration is automatic by reading Simsetup's controller data.

By default, chambers with a Mincon/Simcon controller feature a serial RS 232 interface.

A: 4 CHAMBERS WITH SIMPAC CONTROLLER

Chambers with a Simpac controller are equipped with an Ethernet interface as standard; they are always actuated via TCP/IP.

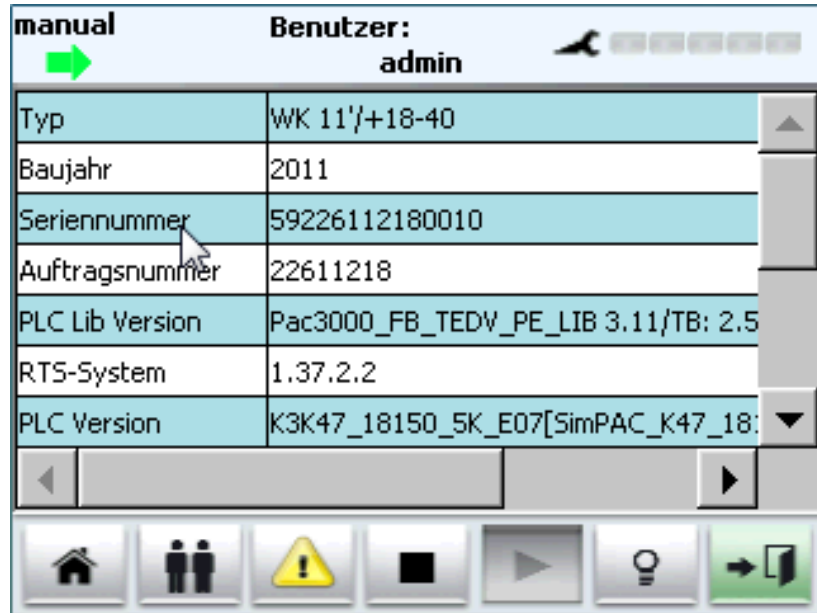

Fig. 4-1: Special functions

In order to use SIMPATI® to operate the chamber, first of all set up the control unit as follows:

- ▶ Go to the menu item below to set the TCP/IP address, subnet mask and default gateway: "Basic menu" → "Settings" → "Configuration" → "Interface" and enable "DHCP" for the automatic TCP/IP address assignment.



Protocols will be recognised automatically. The MAC address is located in the control cabinet on the frame of the control board.

- ▶ To change the operating mode: "Basic menu" → "Settings" → "External" (by clicking on "Internal"). Chambers without a control unit are set to "External" at the factory.
- ▶ Observe the following instructions:
 - Appendix: »Patch cable pin assignment« (page 201)
 - A: 4 »RS 232 interface for Mincon / Simcon and DMR controllers« (page 202)

APPENDIX: MODEL 8990-6C DATA LOGGER SUPPORT

Take the steps below to set up 8990-6C data loggers with checksum for use with SIMPATI®:

A: 1 CONNECT THE INTERFACE CABLE TO THE PC

The interface cable from the data logger package features a 9-pin D-Sub connector you plug into a free RS 232 interface socket on the PC. Your free serial interface may have a 25-pin D-Sub receptacle. If so, use a customary adapter (sold separately).



Mind that this COM port needs to be permanently available for SIMPATI® and verify that no other applications access it.

A: 2 MODIFY THE START FILE

To enable communication, the SIMPATI®.str file in the ..\simpati\system directory needs to be extended by inputting:

```
30:01:simwutdata::
```

As an alternative, the SIMPATI®.str file in the ..\simpati\system directory on the configuration diskette can be copied to the ..\simpati\system directory on the hard drive. Before copying the SIMPATI®.str file, check that SIMPATI® has been exited because you will not be able to copy the file otherwise.



Copying will overwrite special configurations, if any.

► If you have a modified SIMPATI.str, please call our Hotline for assistance.

→ 1.7 »Service hotline« (page 12)

A: 3 PROCURE THE CONFIGURATION FILE

The configuration file is provided by our Service Hotline.

→ 1.7 »Service hotline« (page 12)

Copy the SIMPATI®.cxx configuration file from the configuration disk to the simpati\INIT directory.

In the ..\simpati\INIT directory, change the file extension from .cxx to reflect the chamber number. Assuming that the data logger is the second device supported by SIMPATI®, change the extension to c02.

A: 4 RESTART SIMPATI®

Quit SIMPATI® and restart SIMPATI®.

A: 5 CHECK THE INSTALLATION

After restarting SIMPATI®, the taskbar includes the entry simwutdata.exe.

APPENDIX: PATCH CABLE PIN ASSIGNMENT

The pin assignment for the various other cables can be found in chapter → 3.9 (page 40).

A: 1 ETHERNET INTERFACE OF SIMCON AND SIMPAC CONTROLLERS

For connection to the network you will need a standard twisted connecting cable of the following type: RJ45 patch cable, Cat.5, STP, 4 x 2

A: 2 RS 232 INTERFACE FOR CTC / TC AND MOPS CONTROLLERS

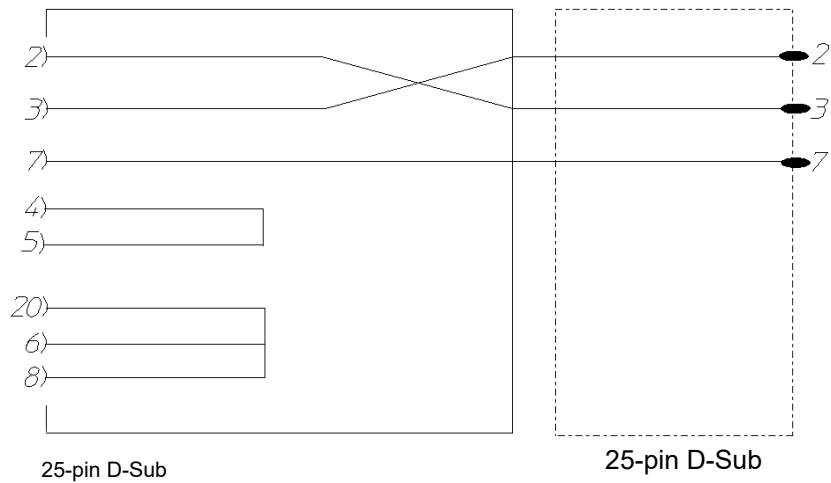

Fig. 2-1: Pin assignment for RS 232 interface cable 25/25 pin for CTC / TC and MOPS controllers

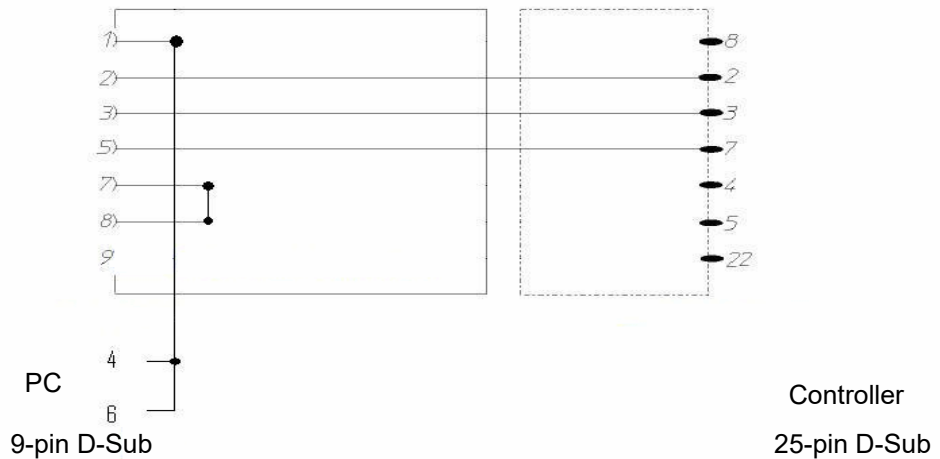

Fig. 2-2: Pin assignment for RS 232 interface cable 9/25 pin for CTC/TC and MOPS controllers

A: 3 RS 485 INTERFACE FOR CTC / TC AND MOPS CONTROLLERS

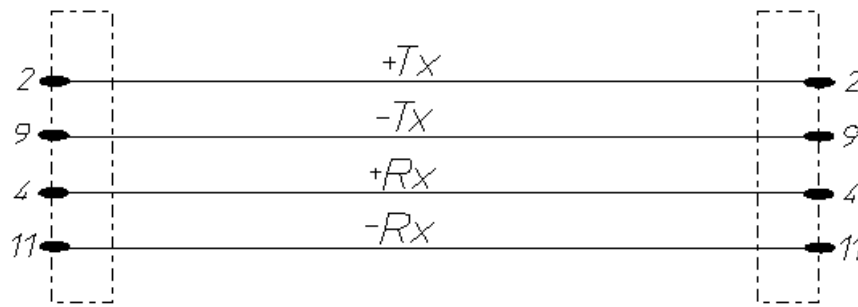

Fig. 3-1: Pin assignment for RS 485 interface cable for CTC / TC and MOPS controllers

A: 4 RS 232 INTERFACE FOR MINCON / SIMCON AND DMR CONTROLLERS

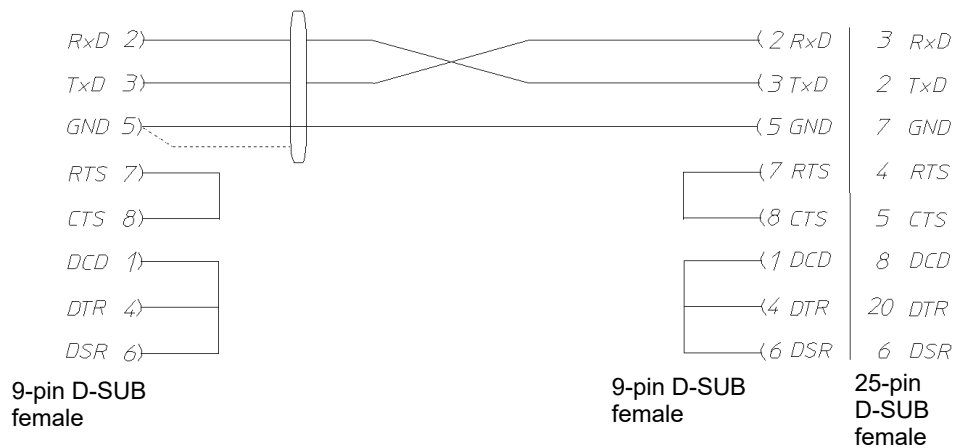

Fig. 4-1: Pin assignment for RS 232 interface cable for Mincon / Simcon / Simpac and DMR controllers

If using the RS 485 interface option (art. no. 63823119), the PC needs to be equipped with an RS 232-to-RS 485 interface adapter (art. no. 63823080).

Chambers with a Simpac controller to be included in a Simcon/Mincon network link in using the RS 232 interface. In this case, the line interfacing conditions and methods of program integration are the same as for Simcon/Mincon controllers. Note that you will need a Minicombox and SIMPATI® v3.0 or higher.

A: 5 RS 485 INTERFACE CABLE FOR MINCON / SIMCON AND DMR CONTROLLERS

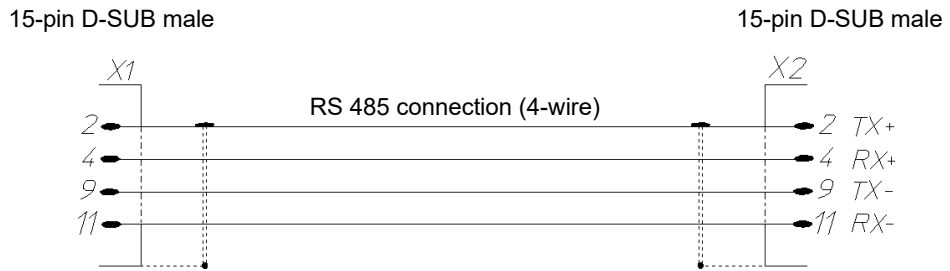

Fig. 5-1: Pin assignment for RS 485 interface cable for Mincon / Simcon and DMR controllers

Bond the shielding extensively to each cable housing.

A: 6 RS 485 INTERFACE CABLE FOR DICON 50X/100X CONTROLLERS AND IMAGO 500

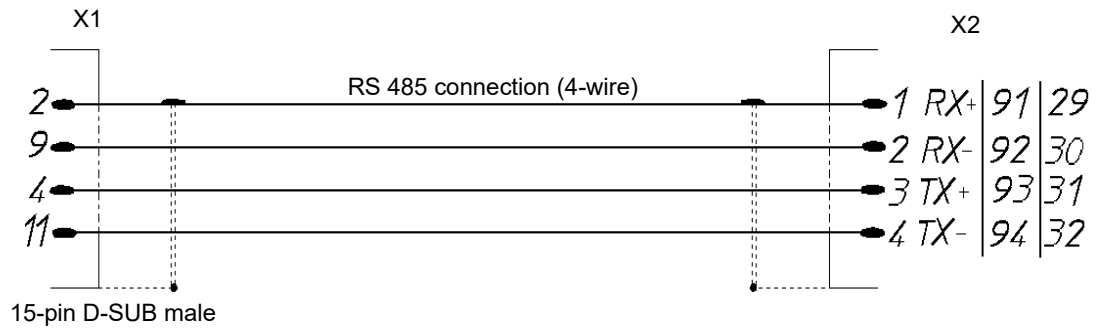

Fig. 6-1: Pin assignment for RS 485 interface cable for Dicon 50x/100x controllers and Imago 500

A: 7 RS 485 AND RS 232 INTERFACE CABLES FOR DICON SM

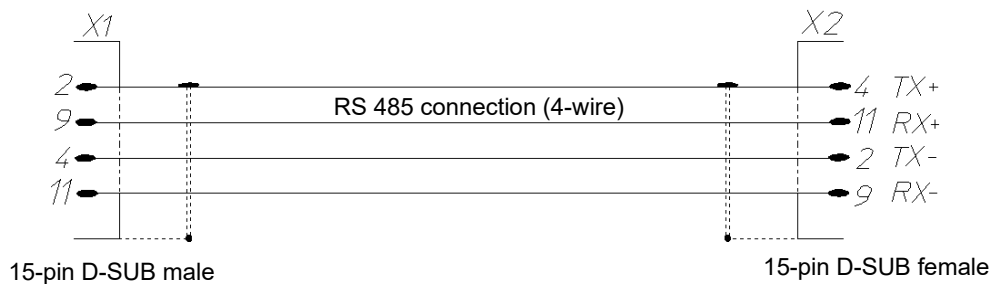

Fig. 7-1: Pin assignment for RS 485 interface cable for Prodicon Plus and SBC controllers

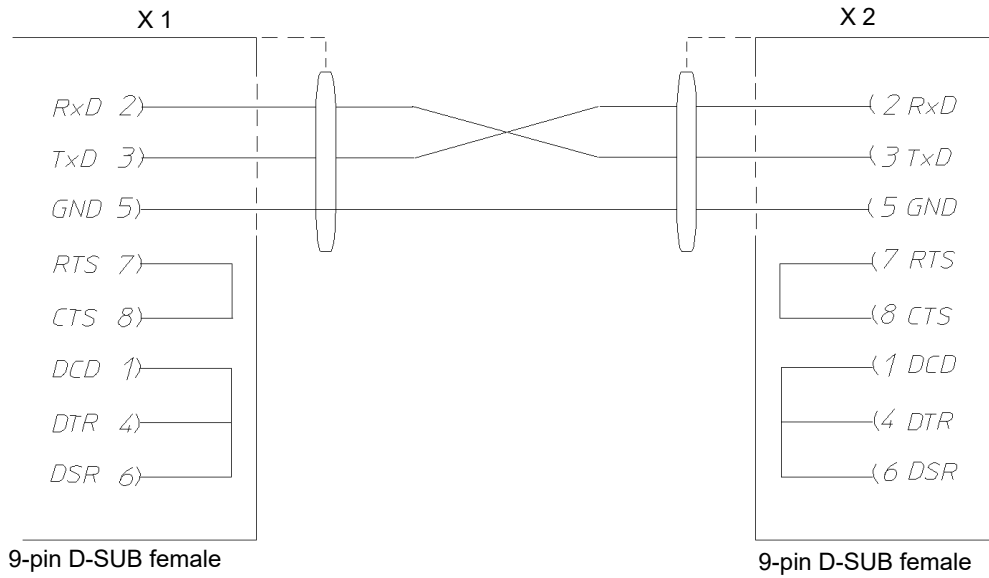

Fig. 7-2: Pin assignment for RS 232 interface cable for Prodicon Plus and SBC controllers

A: 8 RS 232 INTERFACE CABLE FOR 2/3-CHANNEL PROCESS INTERFACE

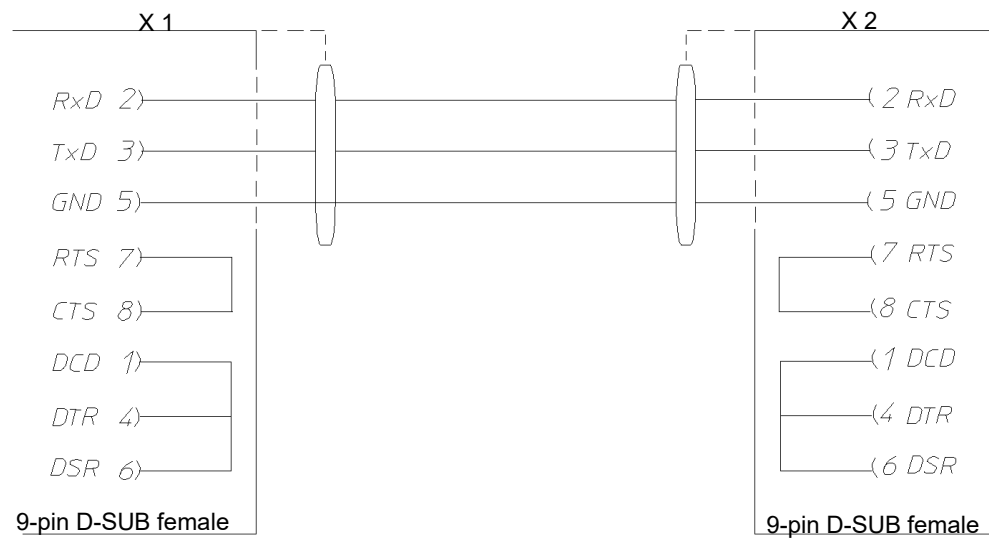

Fig. 8-1: Pin assignment for 232 interface cable for 2/3-channel process interface

A: 9 RS 232 INTERFACE CABLE FOR DICON PRS CONTROLLERS

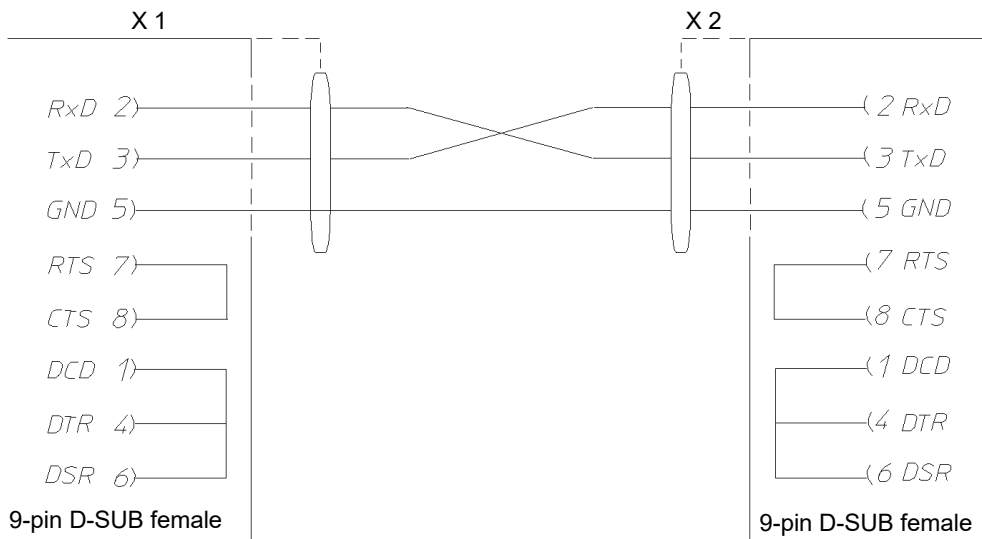

Fig. 9-1: Pin assignment for RS 232 interface cable for Dicon PRS controllers

A: 10 RS 485 INTERFACE CABLE FOR ANAPROG CONTROLLERS



Fig. 10-1: Pin assignment for RS 485 interface cable for Anaprog controllers

A: 11 RS 232 INTERFACE CABLE FOR ZPG 2000 / ZPR 2000 CONTROLLERS

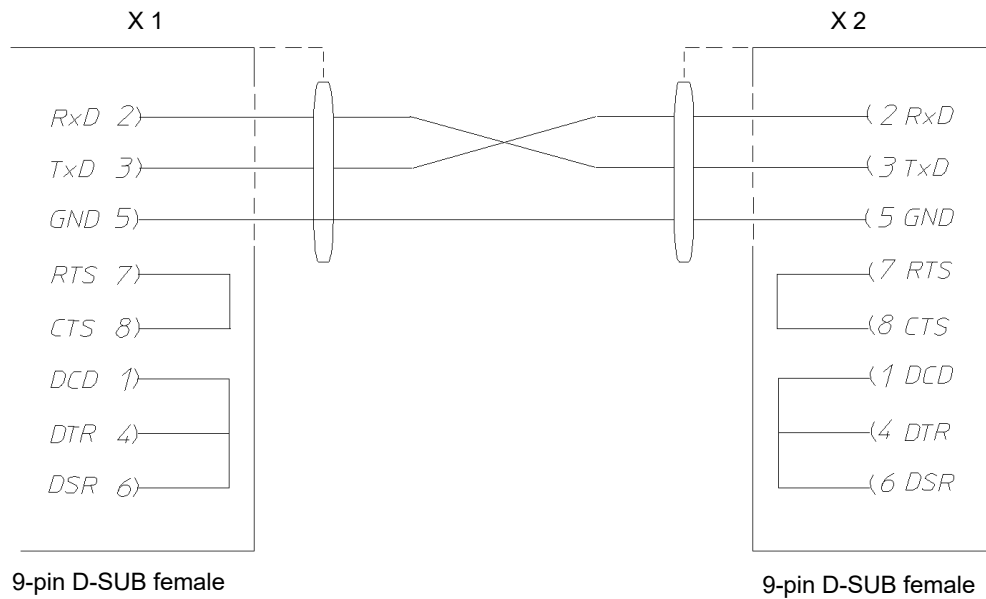

Fig. 11-1: Pin assignment for RS 232 interface cable for ZPG 2000/ZPR 2000 controllers

A: 12 RS 232 INTERFACE CABLE FOR TESTA FID 2000 MP

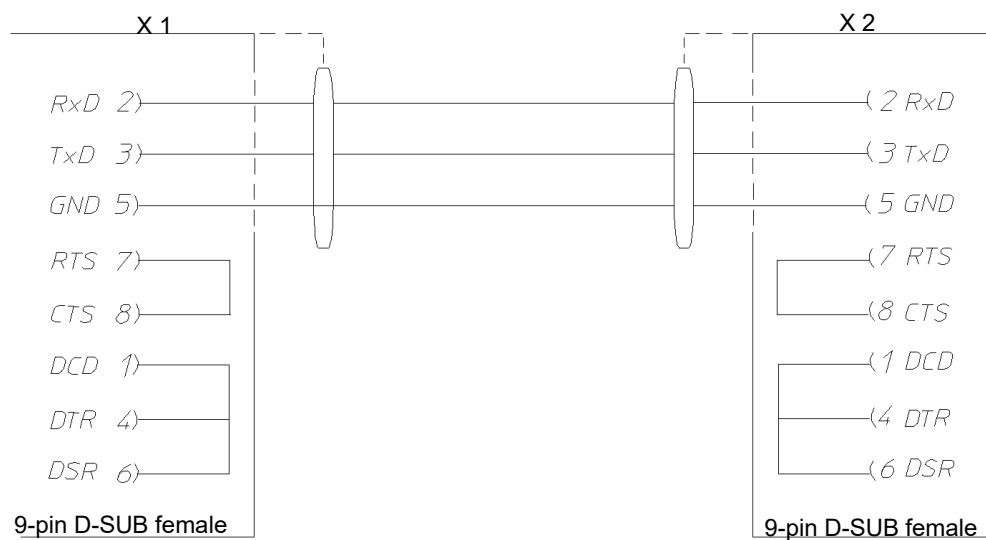

Fig. 12-1: Pin assignment for 232 interface cable for 2/3-channel process interface

APPENDIX: »SIMDOWNLOAD.EXE«

This application supports Simcon, SImpac and Mincon controllers only. The interface is only available in German.

This application allows test programs created in SIMPATI® for a chamber (Item 1) to be uploaded to the chamber controller of this or a compatible chamber.

SIMPATI® must be started, otherwise a download is not possible.

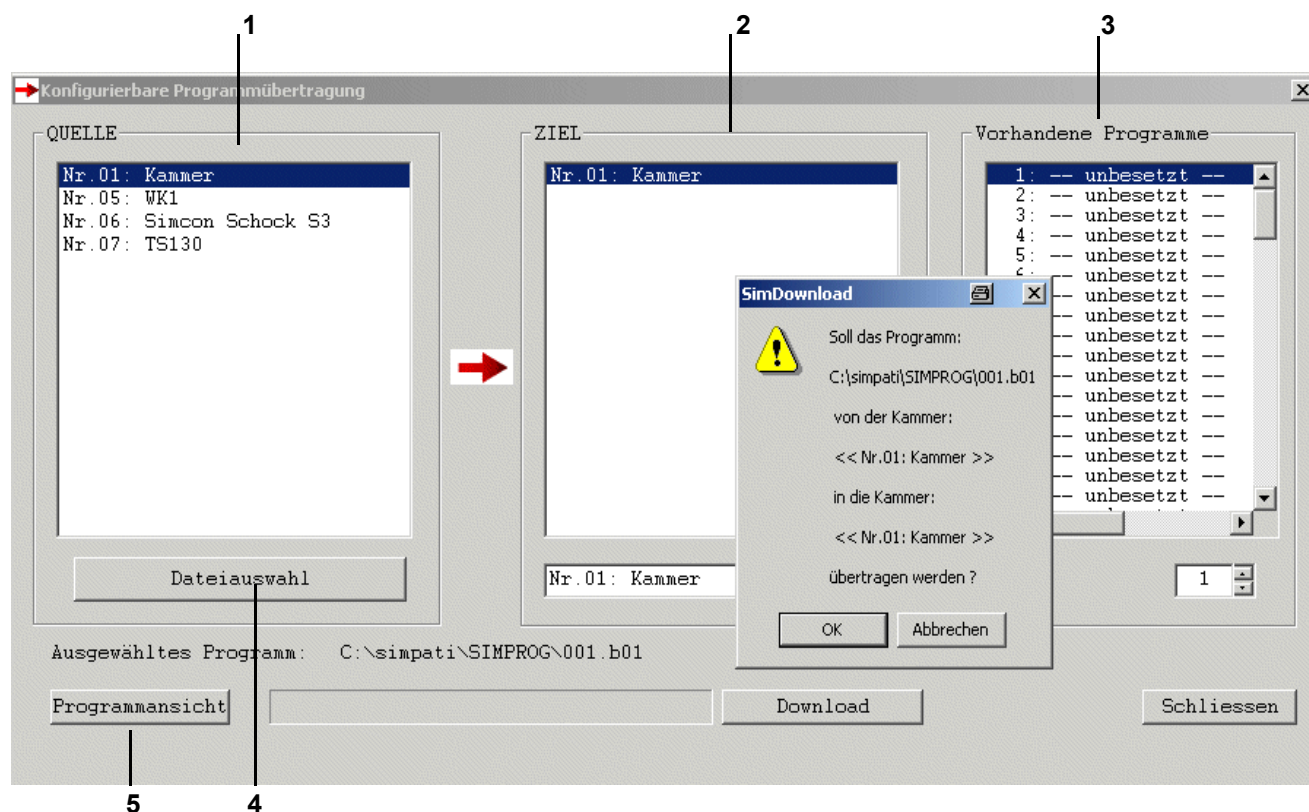

Fig. 0-1: SimDownload's main screen

- 1 All chambers with a Simcon, SImpac or Mincon controller are shown.
- 2 Only chambers that are compatible with the selected source chamber are shown here.
- 3 The test programs that are saved in the selected target chamber are shown here. Select the program number under which the test program should be saved.
- 4 Select the test program here that is to be uploaded to a chamber controller.
- 5 The symbolic editor opens. Here you can review your test program.

APPENDIX: HTTP SERVER

This user interface lets you use any PC to monitor the status of chambers via an intranet or Internet connection without needing to install SIMPATI®. The interface is only available in English.

ATTENTION

Errors during the installation of the HTTP servers due to inadequate information

A free port and a valid IP address are required for TCP/IP communication.

- ▶ Install the HTTP server only after consulting the system administrator.
-

A: 1 PREREQUISITES

Monitoring PC

- Internet access.
- Internet browser:
 - Opera.
 - Netscape Communicator v4.xx or higher
 - Microsoft Internet Explorer v5.5 or higher
 - Mozilla v0.81
- Verify that the SIMPATI® PC can be accessed using its hostname or IP address.

Requirements for the SIMPATI® PC to be monitored

- Administrator privileges.
- Verify that SIMPATI® v2.0 or higher is installed and running on the PC.
- Webserver simhttp.exe automatically generates HTML pages that can be loaded from anywhere in the network. Check that the webserver is up and running. It is located in directory ..\simpati\system.
 - D1: An output window opens on startup.
 - PXXXX: Access goes through port XXXX, the default value is port 7777, e.g.: c:\simpati\system\simhttp.exe -P7777 -D1.

A: 2 STARTING THE HTTP SERVER

By default, the server uses port 7777

Starting manually

- ▶ Activate the HTTP server via the »simhttp.exe« file.

Starting automatically

To automatically run the HTTP server from SIMPATI®, add the following to »simpati.str«:

```
#
# httpServer running on Port 7000
70:01:simhttp:-P7000:
#71:01:simhttp:-P8000 -D1: running on Port 8000 and opens Debug Window
#
```

Fig. 2-1: Example of »Simpati.str«

You may make several entries with different ports at once.

The http server does not support any 64-bit Java version.

Therefore, depending on the operating system and the Java version you use, problems may occur when displaying SIMPATI®'s http server: The http server won't run or the website is not displayed in the browser.



- ▶ In this case it is necessary to install a Java 32-bit version in the main partition of the computer (usually "C:\") and to start the http server with path specification.

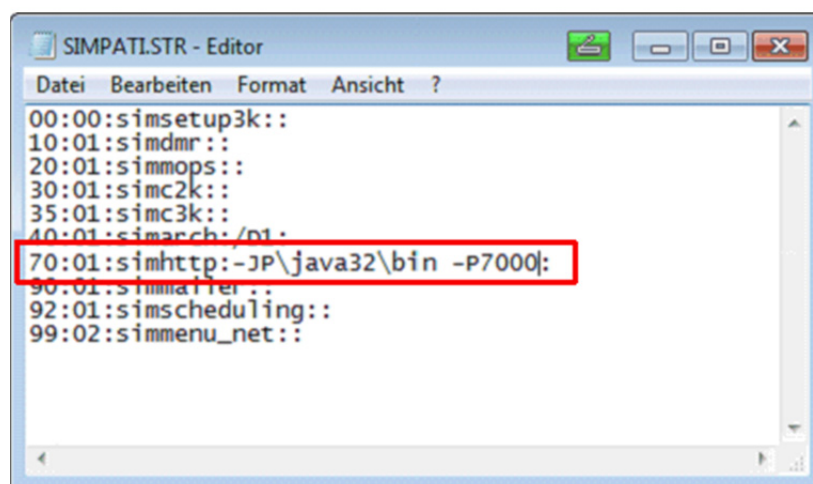

Fig. 2-2: simpati.str



The Java version must not update itself automatically.

A: 3 ACCESSING SIMPATI®

Enter the IP address or the hostname (including the URL) of the SIMPATI® PC. This may look as below:

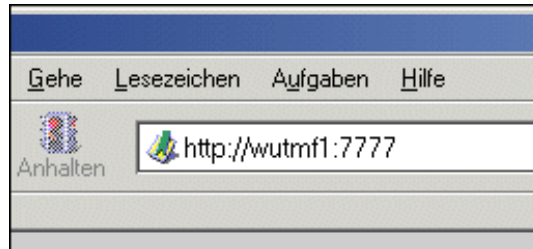

Fig. 3-1: Example SIMPATI® PC address (here Netscape 6)

http:// - protocol (hence the name of the server).

wutmf1 or 192.168.1.12 - hostname or IP address of the SIMPATI® PC.

:7777 - default port on the server which awaits queries from the client.

The HTTP page will now build up and refresh automatically.

A: 4 HTTP SERVER USER INTERFACE

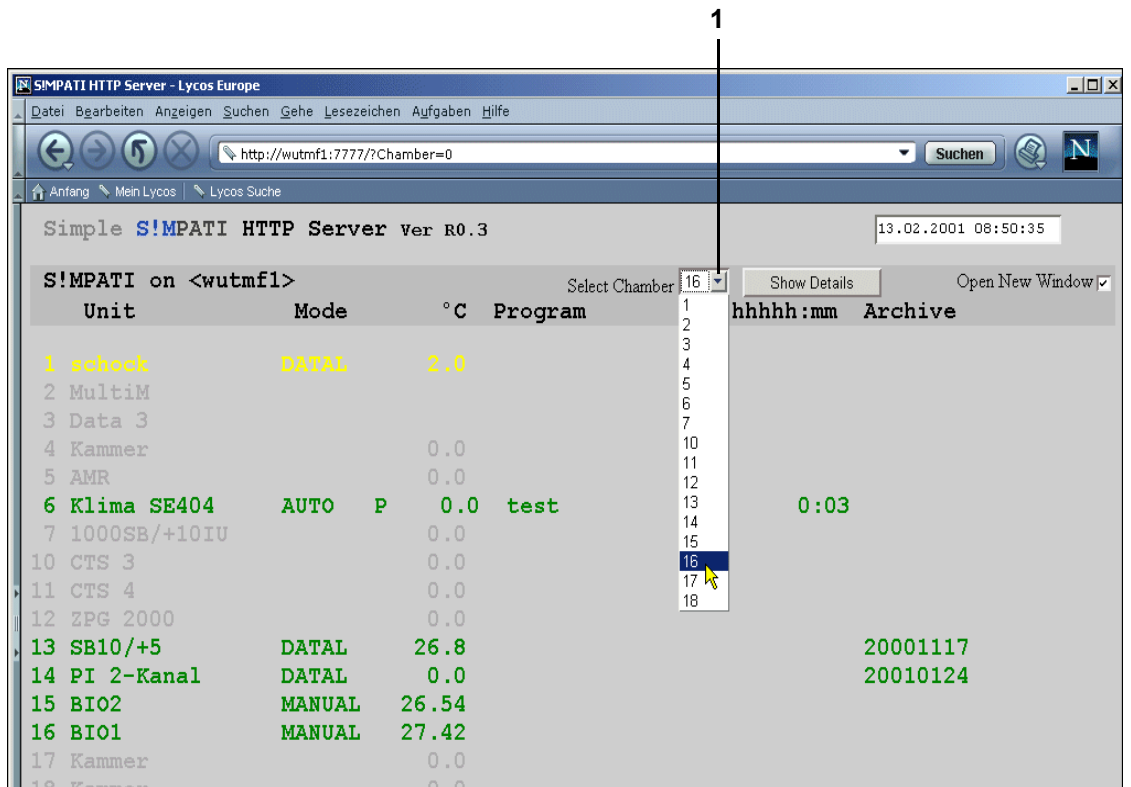

Fig. 4-1: Server interface

Select the chamber needed from the list under Item 1. You get the status display.

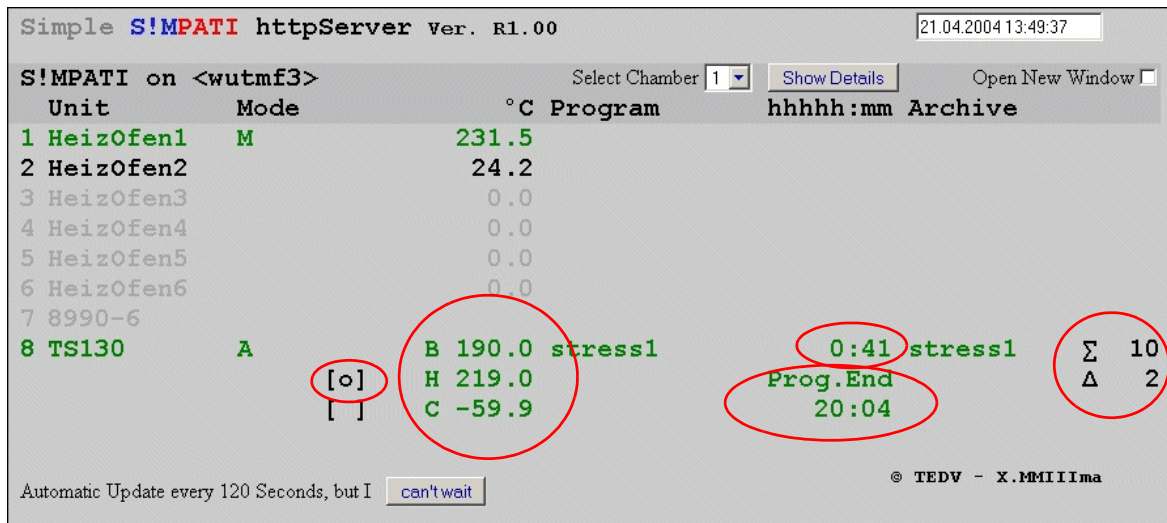

Fig. 4-2: Example: Interface for a shock chamber

B 190.0:	Temperature in lifting basket.
H 219.0:	Temperature in hot chamber.
C -59.9:	Temperature in cold chamber.
[o]	Lifting basket position.
0:41:	Time elapsed since the start of the test.
Prog. End 20:04:	The test is expected to end at this time (enter date, as necessary). This is an average value calculated from the duration and the number of cycles elapsed and the cycles yet remaining.
Σ 10:	10 cycles remaining.
Δ 2:	2 cycles gone.

APPENDIX: S!MPATI® TCP/IP PORT (SIMSERV)

A: 1 DESCRIPTION

SIMSERV offers optional authentication and encrypted communication.

Activation of encryption automatically activates the user authentication → *Fig. 4-7: »Set Parameters« (page 219).*

The user authentication for encrypted communication is based on the user administration implemented in S!MPATI®. The user logged in can execute commands or operations for which he has permission in S!MPATI®.

SIMSERV Permits both encrypted and unencrypted communication over both IPv4 and IPv6 TCP protocol families. A parallel operation of both sockets is also possible so that one client communicates via IPv4 and another via IPv6 at the same time.



Several commands can be sent one after the other without having to re-establish a connection after each command.

A: 2 FUNCTION

The mode of operation is illustrated below:

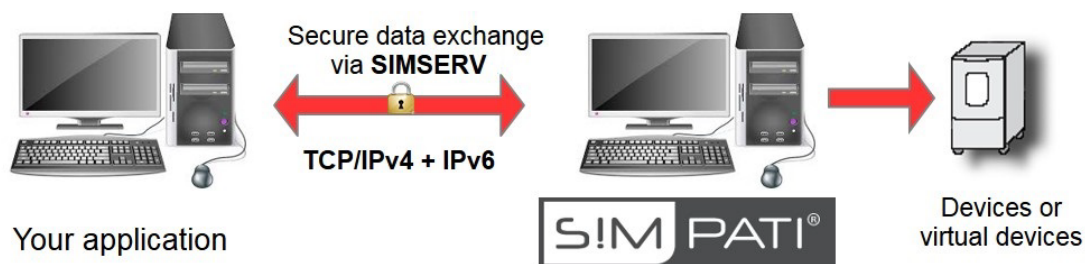

Fig. 2-1: Overview of the mode of operation

A: 3 COMMAND STRUCTURE

A permanent socket connection to the server is established. A session is opened for every client, in which the client can communicate with the server uninterrupted. The connection on the client side is closed when communication ceases. The server ends the session.

The following structure must be observed for every client:

Unencrypted communication

- 1) Establish connection
 - 2) Send command
 - 3) Read response
 - 4) Close connection
- } n-times

Encrypted communication

- 1) Establish connection
 - 2) Authenticate user on the server with user name and password
 - 3) Send command
 - 4) Read response
 - 5) Close connection
- } n-times

A: 4 ENCRYPTED COMMUNICATION

An SSL certificate from Windows must be provided for the encryption of messages. To use an existing certificate configuration using parametrisation is required. The parameters are described in the parameter list (→ A: 6.2 *Parameter*).

A test certificate specially created by the Weiss Group can be installed and used for test purposes (→ A: 0.1 *Installation of test certificate*).

A: 0.1 Installation of test certificate

- ▶ Go to the SIMPATI® installation directory and click on:
 `..\Simpati\Tools\Testzertifikat\Server.pfx`

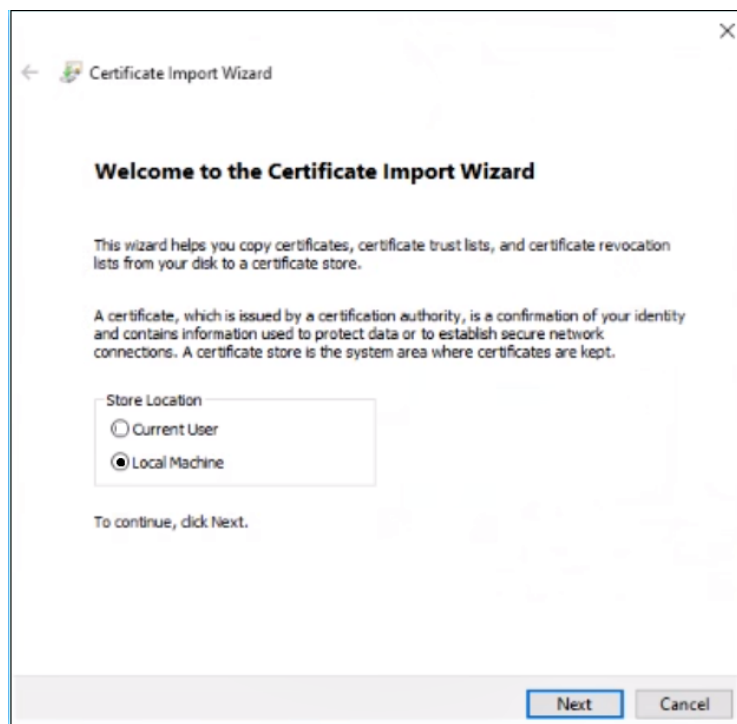

Fig. 4-1: Certificate Import Wizard - Step 1

- ▶ Select “Local Machine”



If “Current user” is selected and if the Simpati service is installed on the system, SIMPATI® Web the test certificate must be installed for the local Windows user “Simpati”.

- ▶ Log in with the Windows user “Simpati”.
- ▶ Execute certificate installation.

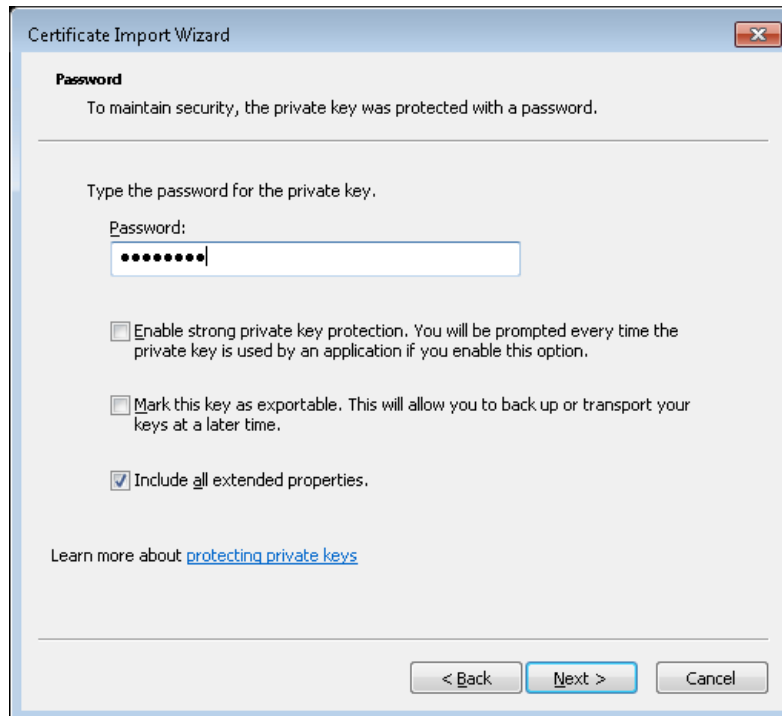

Fig. 4-2: Certificate Import Wizard - Step 2

- ▶ Enter the password *TestCert201*.

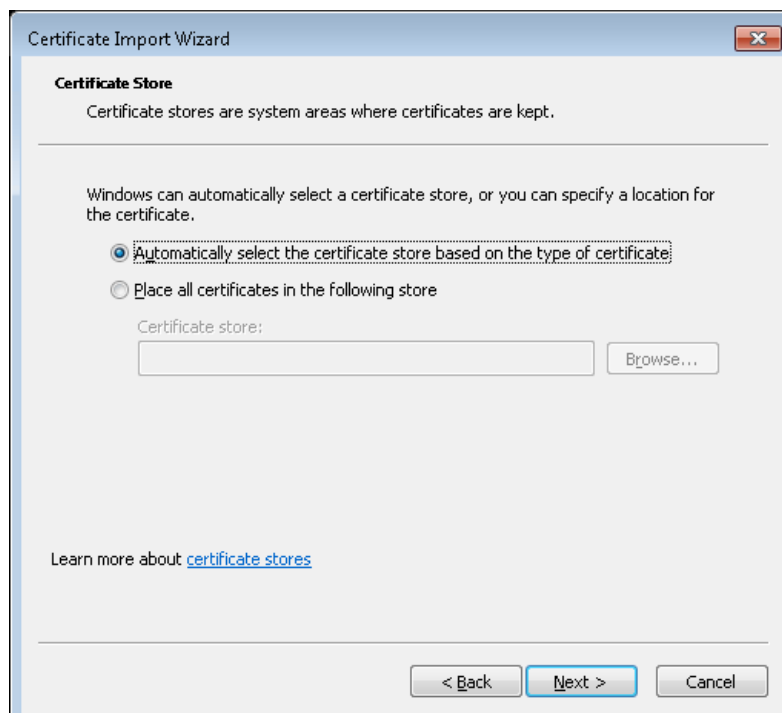

Fig. 4-3: Certificate Import Wizard - Step 3

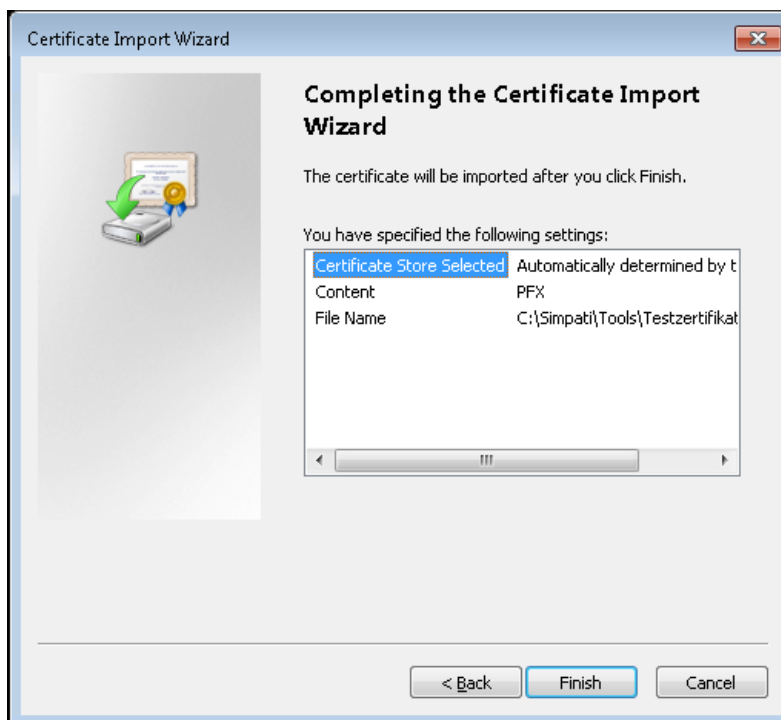

Fig. 4-4: Certificate Import Wizard - Step 4

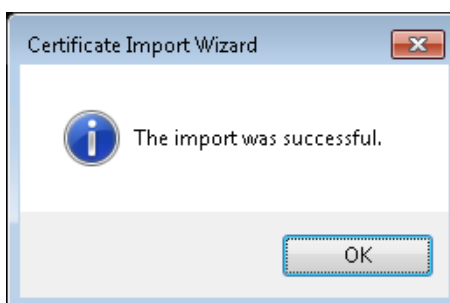

Fig. 4-5: Certificate Import Wizard - Step 5

- ▶ Start SIMSERV via an entry in the simpati.str file in the ..\simpati\system directory.

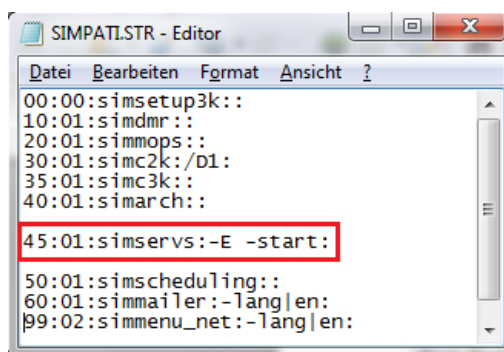

Fig. 4-6: Simpati.str

- ▶ Then restart SIMPATI®.

ATTENTION

Conflicts when modifying simpati.str

- ▶ Quit SIMPATI® before modifying the configuration.
- ▶ The Notepad program contained in Windows must be used to open the file. Make sure to use consecutive numbering when entering. Incorrect entries can cause SIMPATI® to crash.
- ▶ When starting several secure SIMSERV instances at the same time, make sure that the port is specified explicitly. The ports must differ from each other so that conflicts in ports do not occur.

A: 6.2 Parameter

The following parameters are defined for starting SIMSERV:

Parameter	Description	Remarks
/? or -? or -/h or -h	Displays Help for the SIMSERV start parameters.	
-D1	Control readouts of communication values (including passwords) are displayed as unencrypted plain text.	<i>Optional</i> <i>Standard:</i> no control readouts
-Pxxxx	Port definition for the SIMSERV. xxxx stands for a four-digit number that defines the port number via which the SIMSERV communicates.	<i>Optional</i> <i>Standard:</i> Port 8888 for encrypted communication. Port 7777 for unencrypted communication.
-E	Encrypted communication.	<i>Optional</i> <i>Standard:</i> unencrypted communication
-N"ServerName"	Name of the server (CN value in the certificate). Quotation marks are necessary in the case of names that contain spaces.	<i>Optional</i> <i>Standard:</i> "Weiss Group SIMSERV" Ignored in unencrypted communication.
-S"StoreName"	Certificate store in which the certificate is installed. Possible values: "Root" = certificate store for reliable root certificate authorities. "My" = certificate store for personal certificates. "Own name" = extra certificate store applied Quotation marks are necessary in the case of names that contain spaces.	<i>Optional</i> <i>Standard:</i> "Root" Ignored in unencrypted communication.

Table 0-1 Parameters for starting SIMSERV

Parameter	Description	Remarks
-start	SIMSERV communication is started.	<i>Optional Standard:</i> no automatic communication start. To start communication, click on the on-screen Start button.

Table 0-1 Parameters for starting SIMSERV

If you start SIMSERV without parameters (**xx:01:simserv:**), all parameters can also be set on the user interface and communication can be started.

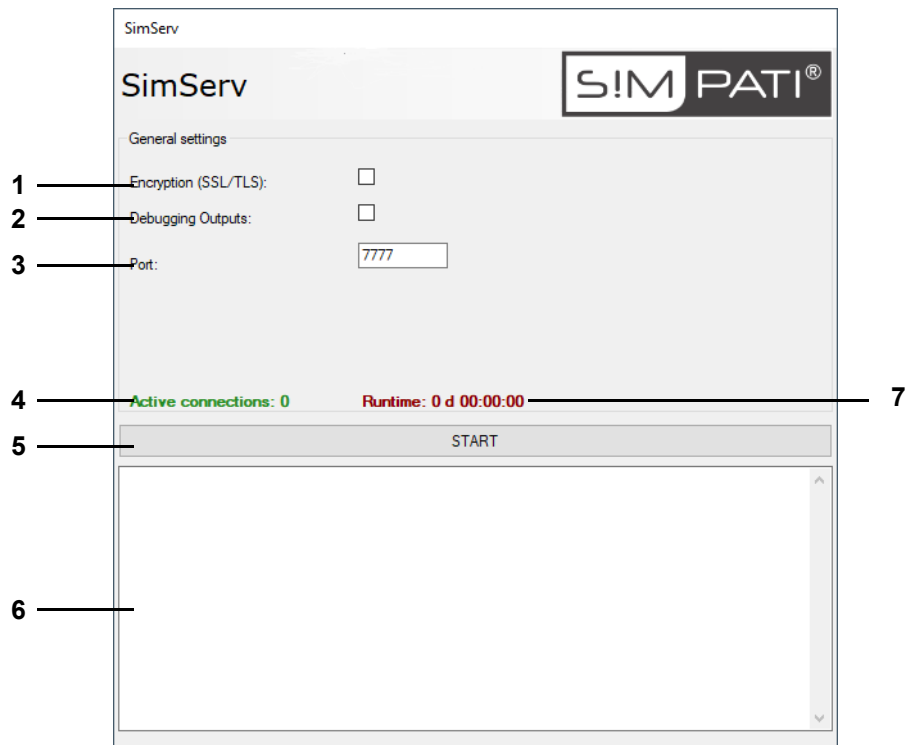

Fig. 4-7: Set Parameters

- 1 Activate encrypted communication (-E).
- 2 Activate control readouts (-D).
- 3 Set port number (-P7777).
- 4 Number of clients currently connected.
- 5 Start communication (-start).
- 6 Control output panel.
- 7 Runtime since the start of communication.

A: 7.3 Examples

70:01:SIMSERV:-P9999:

Port 9999, unencrypted, no control output, no automatic start, communication to start using the on-screen Start button.

70:01:SIMSERV:-start:

Port 7777, unencrypted, no control output, communication starts automatically with SIMPATI.

70:01:SIMSERV: -E -start:





Port 8888, encrypted, server name "Weiss Group SIMSERV", certificate stored at "Root", no control output, communication starts automatically with SIMPATI.

70:01:SIMSERV:-P5555 -E -N"*.simpati.com" -S"Webhosting" -D1 -start:

Port 5555, encrypted, server name "*.simpati.com", certificate stored at "Webhosting", with control output, communication starts automatically with SIMPATI.

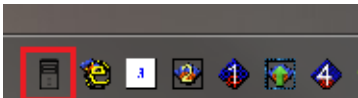
A: 7.4 Taskbar icons

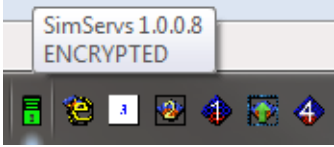
The following graphic elements can be found in the taskbar after SIMSERV Start:

SIMSERV running, no communication.	
SIMSERV running, communicating.	
Hover the mouse over the icon to display the version and the type of communication	
Right-click on the icon to show or hide the user interface or to exit .	

A: 5 FUNCTION COMMANDS

The make-up of function commands (SIMSERV commands for data exchange with SIMPATI®) is illustrated below.

A: 0.1 Make-up

Function commands are made up as follows:

Make-up									
Command	Sep	Chamber index	Sep	Argument 1	Sep	Argument 2	Sep	etc., up to 4 arguments, depending on the function	CR

Tab. 5-2: Function commands make-up

Sep = separator = "¶" (ASCII 182)

CR = carriage return (\r) at end of command (ASCII 13)



In some clients (e.g. LabView) an LF (LineFeed) must be appended to the CR to ensure that the return values are received correctly.

In case of an error

ErrorCode	CR
-----------	----

Tab. 5-3: Error

is returned as the status, where the following error codes are possible:

Error code	Error text
-1	Empty string received.
-2	No chamber ID.
-3	Chamber ID out of valid range.
-4	Chamber does not exist.
-5	Unknown command ID.
-6	Too few or incorrect parameters.
-7	No server (for server service functions).
-8	Control variables etc. of this ID not found.
-9	Error executing the command.
-10	Index error executing the command.
-11	No user logged in - command cannot be executed (encrypted communication only).
-12	The user logged in to SIMSERV is not privileged to execute the command.
-13	Duplicate login (the user is attempting to log himself back in to the open session).

Tab. 5-4: Error codes

If there are no errors a "1" is returned.

A: 0.5 Examples

Authenticating on SIMSERV (opening a session)

23022	↑	User name	↑	Password	↑	CR
-------	---	-----------	---	----------	---	----



- To authenticate, use the credentials on an existing SIMPATI® user.

Server response on successful login:

1	↑	LOG IN	CR
---	---	--------	----

Set nominal temperature of 2nd chamber to 25 °C

11001	¶	2	¶	1	¶	25.0	CR
-------	---	---	---	---	---	------	----



The 1st control variable (temperature) always returns 2, the 2nd control variable (e.g. humidity) returns 2, etc.

Set actual temperature of 2nd chamber to 30 °C

11003	¶	2	¶	1	¶	30.0	CR
-------	---	---	---	---	---	------	----

Query actual temperature of 2nd chamber

1004	¶	2	¶	1	¶	CR
------	---	---	---	---	---	----

Response of the server to a GET ACTUAL VALUE command:

1	¶	23.90	CR
---	---	-------	----

Set digital channel 1 (start) of 2nd chamber

14001	¶	1	¶	1	¶	true	CR
-------	---	---	---	---	---	------	----

Start/stop archiving of “test 2nd chamber”

18011	¶	2	¶	test	CR
19050	¶	2	¶	256	CR
19050	¶	2	¶	512	CR

A: 6 TEST PROGRAM

The TCP/IP connection can be tested using the "SecureServTest.exe" client test program. The test program is stored at ...\\simpati\system. First of all, start SIMSERV communication.

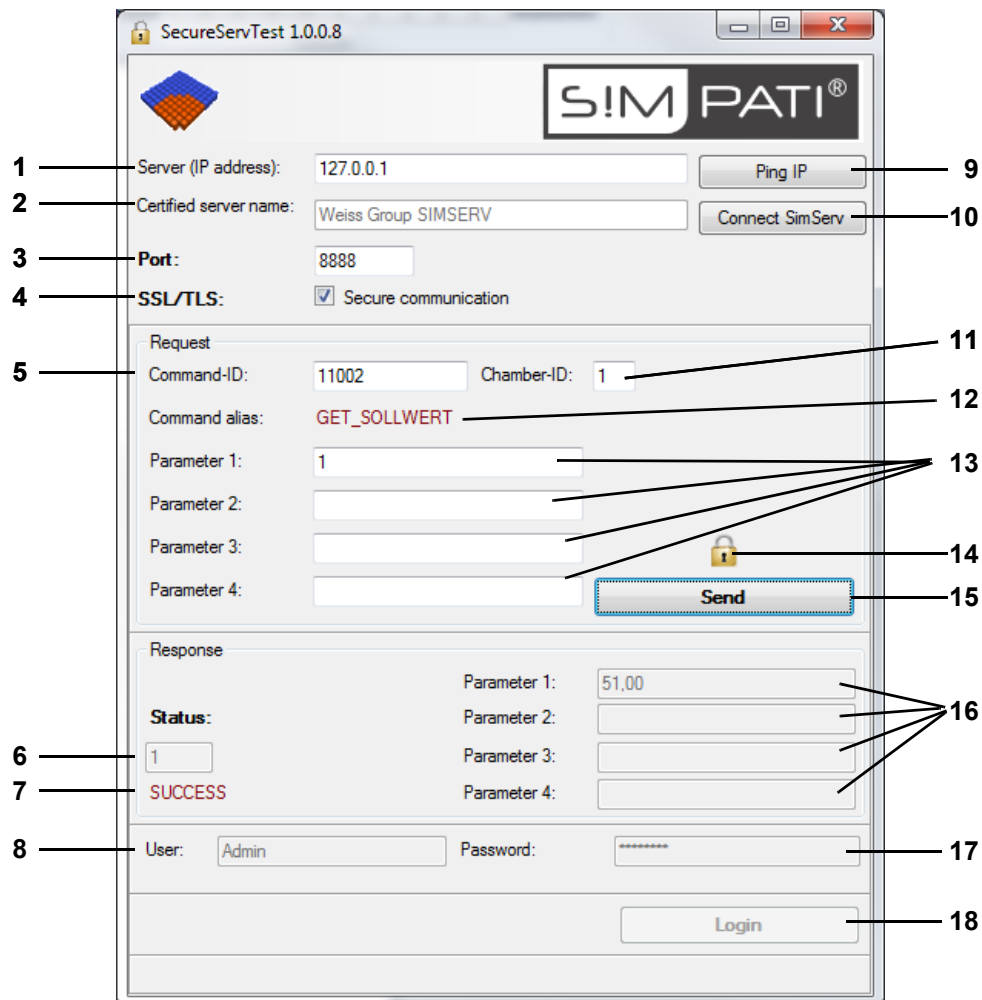

Fig. 6-1: SecureServTest

- 1 SIMPATI® computer's IP address (IPv4 or IPv6)
- 2 SIMSERV server name.
- 3 SIMSERV port.
- 4 Set encrypted / unencrypted communication.
- 5 Command.
- 6 Status.
- 7 Status alias.
- 8 Name of logged-in user (active prior to login).
- 9 Test accessibility of IP address.
- 10 Connect to the SIMSERV server.
- 11 Chamber index.
- 12 Command alias.

13 Parameters 1-4.

14 Icon for encrypted communication.

Click on icon to get certificate details from the SIMSERV server.

15 Send command.

16 Response parameters 1-4.

17 Password (active prior to login).

18 Login (active prior to login).

A: 7 COMMAND LIST

Available functions

COMMAND	Fct.no	Arg. 1	Arg. 2	Arg. 3	Arg. 4	Response	
AUTHENTICATION							
SET USER	230022	Index	Use name ¹	Password		1 LOGIN	
GET USER	230023	Index				User name	
CHAMBER INFORMATION							
GET CHAMBER NAME	10006	Index				CHAMBER NAME	
GET CHAMBER TYPE	10017	Index				SimCon	33333
						Simpac	44444
GET CONTROL VARIABLE_COUNT	11018	Index				Number of CONTROL VARIABLEs	
GET DIGITAL CHANNEL_COUNT	14007	Index				Number of DIGITAL CHANNELs	
GET COUNTER_COUNT	16001					Number of COUNTERs	
GET ERROR_COUNT	17002	Index				Number of ERRORS	
GET OPERATING STATUS	10012	Index				AVAILABLE	0x1
						RUN	0x2
						WARNING	0x4
						ERROR	0x8
GET OPERATING MODE	10010	Index				DATA LOGGING	0x01
						MANUAL	0x02
						AUTOMATIC	0x04
						BREAK	0x08
						BUSY	0x10
GET SCANNING CYCLE TIME	10034					SCANNING CYCLE TIME	
GET ARCHIVE PATH	10024					Text	
GET PROGRAM PATH	10026					Text	
CONTROL VARIABLE							

Tab. 7-1: Command list

COMMAND	Fct.no	Arg. 1	Arg. 2	Arg. 3	Arg. 4	Response
GET NAME	11026	Index				NAME
GET UNIT	11023	Index				UNIT
SET NOMINAL VALUE	11001	Index	Value	Use name ¹		
GET NOMINAL VALUE	11002	Index				NOMINAL VALUE
GET ACTUAL VALUE	11004	Index				ACTUAL VALUE
GET INPUT LIMIT MIN	11007	Index				MIN
GET INPUT LIMIT MAX	11009	Index				MAX
GET WARNING LIMIT MIN	11016	Index				MIN
GET WARNING LIMIT MAX	11017	Index				MAX
GET ALARM LIMIT MIN	11014	Index				MIN
GET ALARM LIMIT MAX	11015	Index				MAX
CONTROL VALUE						
GET NAME	13011	Index				NAME
GET UNIT	13010	Index				UNIT
GET NOMINAL VALUE	13005	Index				NOMINAL VALUE
SET NOMINAL VALUE	13006	Index	Value	User name ¹		
GET INPUT LIMIT MIN	13002	Index				MIN
GET INPUT LIMIT MAX	13004	Index				MAX
MEASURED VALUE						
GET NAME	12019	Index				NAME
GET UNIT	12016	Index				UNIT
GET ACTUAL VALUE	12002	Index				ACTUAL VALUE
GET WARNING LIMIT MIN	12010	Index				MIN
GET WARNING LIMIT MAX	12011	Index				MAX
GET ALARM LIMIT MIN	12008	Index				MIN
GET ALARM LIMIT MAX	12009	Index				MAX
DIGITAL OUTPUT CHANNELS						

Tab. 7-1: Command list

COMMAND	Fct.no	Arg. 1	Arg. 2	Arg. 3	Arg. 4	Response
SET DIGITALOUT	14001	Index	1/0 ON/OFF	User name ¹		
GET DIGITALOUT	14003	Index				DIGITALOUT, 0/1
DIGITAL INPUT CHANNELS						
GET DIGITALIN	15002	Index				DIGITALIN, 0/1
COUNTER						
GET NAME	16015	Index				NAME
GET ACTUAL VALUE	16003					COUNTER value
ERROR						
GET ERROR TEXT	17007	Index				ERROR TEXT
GET ERROR STATUS	17009	Index				ERROR STATUS, 0/1
GET ERROR CLASS	17005	Index				Control 1=Alarm 2=Warning 4=Note SIMPATI® 5=Alarm 6=Warning
AUTOMATIC MODE						
SET STARTZPGPRGNUMBER	19014	Index	Prog. no.	Loops	User name ¹	
SET STOPZPGPRG	19015	Index			User name ¹	
SET DOWNLOAD	19001	Index	Prog. name	Prog. slot	User name ¹	
GET PROGRAM NAME	19031	Index				Program name
GET PROGRAM STATUS	19062	Index				TRUE / FALSE (1/0)
GET PROGRAM START	19064	Index				Param1-4: name, loops, WARM-UP TIME, START DATE
SET PROGRAM MODE	19050	Index	BREAK 0x20 CONTIN UE 0x40		User name ¹	

Tab. 7-1: Command list

COMMAND	Fct.no	Arg. 1	Arg. 2	Arg. 3	Arg. 4	Response
SET ALL LOOPS	19003	Index	0=External 1=Internal			
GET ALL LOOPS	19004	Index	0=External 1=Internal			ALL LOOPS
GET ACTUAL LOOPS	19006	Index	0=External 1=Internal			ACTUAL LOOPS
ARCHIVING						
SET ARCHIVE NAME	18011	Index	Archive name	User name ¹		
SET ARCHIVING (SIMPATI® v2.0 or higher)	19050	Index	START 0x1000 STOP 0x2000	User name ¹		
SET ARCHIVE COMMENT	18023	Index	Text	User name ¹		
GET ARCHIVE COMMENT	18024					Text
GET ARCHIVE NAME	18012					Text

Tab. 7-1: Command list

¹ Argument is optional and only required for encrypted communication with user authentication

0.1 Define general chamber settings

The value is preset and cannot be changed.

0.2 Email

The SimMailer can also be called up via an icon in the main menu.

0.3 Installation for operation in the pharmaceutical sector

The installation of SIMPATI® in the pharmaceutical sector is only possible with version SIMPATI®2016, from patch 2.1.

APPENDIX: ETHERNET INTERFACE

The Ethernet interface is intended solely for use with the SIMPATI® software package.



- ▶ If SIMPATI® is embedded in a LAN, make sure to prevent conflicts with other network stations when applying the communication paths and addresses (e.g. double connections).
- ▶ We strongly recommend you to have the network administrator set up the network.



ATTENTION

Impairment of network operation due to improper configuration

Improper configuration may adversely affect network operation even outside the SIMPATI® network.

- ▶ The network must be set up by the network administrator.



The MAC address can be found on the processor if you have a Simcon controller or on the frame of the control board if you have a Simpac controller.

A: 1 PREPARATION

- ▶ Configure the chamber.
- ▶ Assign each chamber a unique IP address. On doing so, make sure that the IP address has only been assigned once on the entire network. Use the control unit to set the IP address. Using the Ethernet interface will not be enabled if this option is not available. Please contact the Hotline.
Normally, you can use the default port 7777. Or you can choose another port between 7001 and 7999.



Remember to enter the same port when loading and starting the driver.

A: 2 ESTABLISH THE NETWORK CONNECTION

- ▶ Connect the controller to the nearest hub or switch intended for this purpose using a suitable network cable.

A: 3 CHECK THE NETWORK CONNECTION TO THE PC

- ▶ Make sure that the PC designated is connected to the network and that the TCP/IP installation has been carried out correctly.

- ▶ The connection to the appropriate chamber can be tested via »Execute Start«.

Example: → A: 5 »Example of networking two chambers via Ethernet« (page 233)

If checking is successful, the next step is to load the chamber configuration.

A: 4 READ THE »SCANNING« CONFIGURATION FILE

- ▶ Make sure that SIMPATI® has not been started.
- ▶ Start the scanning process in the ..\simpati\system directory by entering the following:
- ▶ Simc2k /SCAN_TCIP#[IP address]#7777#[Index]#[logic address]

Index: SIMPATI® chamber number, e.g. 1, 2, 3, 4 etc.

Logic address between 51 and 99

Example:

→ A: 5 Example of networking two chambers via Ethernet → »Read the »Scanning« configuration file« (page 235)

Assign a distinct logic address to every chamber.

Now load the chamber configuration. The following box will pop up if scanning is successful.

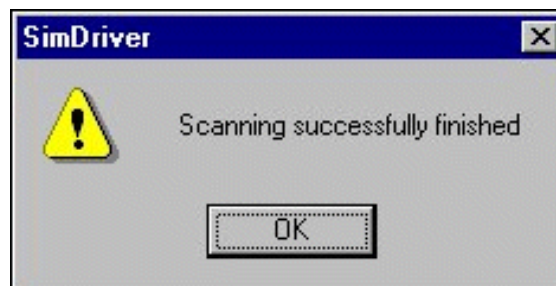

Fig. 4-1: Scanning successful

A separate entry per chamber is added to file simpati.adr in directory ..\simpati\system.

→ »Read the »Scanning« configuration file« (page 235)

Repeat this step in the event of an error. If this does not work, check the IP address and port on the control unit.

- ▶ Check the connection again using the command: ping [IP address].
- ▶ Also, read the configuration in for all of the other chambers that are to be networked via Ethernet.

Adapt file SIMPATI®.str

File SIMPATI®.str may contain the following entry:
#30:01:simc2k:/Com#TCPIP_XX:

(XX=logic address between 51 and 99)

Generate a line for each chamber connected via Ethernet, replacing XX with the appropriate logical chamber address assigned during scanning.

- ▶ Use the desktop icon to launch SIMPATI®.

A: 5 EXAMPLE OF NETWORKING TWO CHAMBERS VIA ETHERNET

IP addresses assigned:

First chamber: 192.168.121.36

Second chamber: 192.168.121.37

The directory is: ..\simpati\system

Check the network connection

- ▶ Open cmd.exe file:

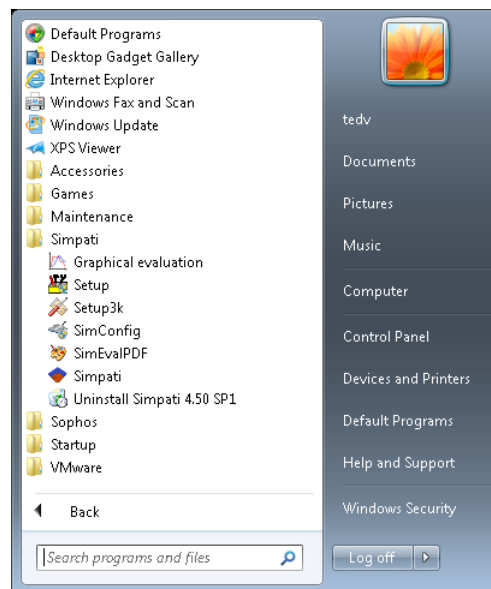
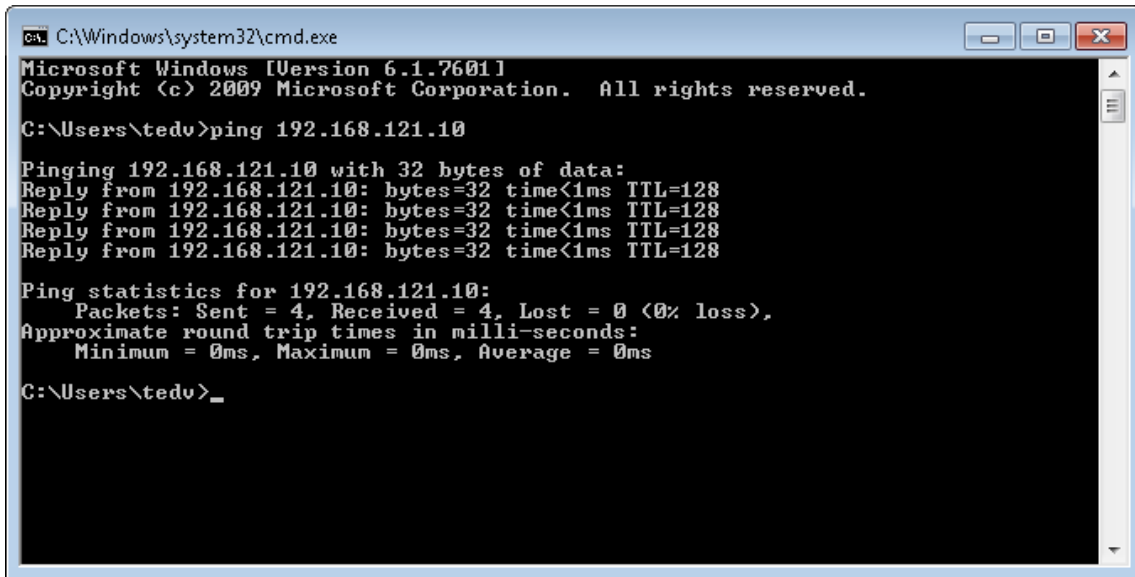

Fig. 5-1: Executing cmd.exe file

- ▶ Input: ping 192.168.121.36

Response:



```
ca: C:\Windows\system32\cmd.exe
Microsoft Windows [Version 6.1.7601]
Copyright (c) 2009 Microsoft Corporation. All rights reserved.

C:\Users\tedu>ping 192.168.121.10

Pinging 192.168.121.10 with 32 bytes of data:
Reply from 192.168.121.10: bytes=32 time<1ms TTL=128
Reply from 192.168.121.10: bytes=32 time<1ms TTL=128
Reply from 192.168.121.10: bytes=32 time<1ms TTL=128
Reply from 192.168.121.10: bytes=32 time<1ms TTL=128

Ping statistics for 192.168.121.10:
    Packets: Sent = 4, Received = 4, Lost = 0 (0% loss),
    Approximate round trip times in milli-seconds:
        Minimum = 0ms, Maximum = 0ms, Average = 0ms

C:\Users\tedu>_
```

Fig. 5-2: Connection OK

Response:

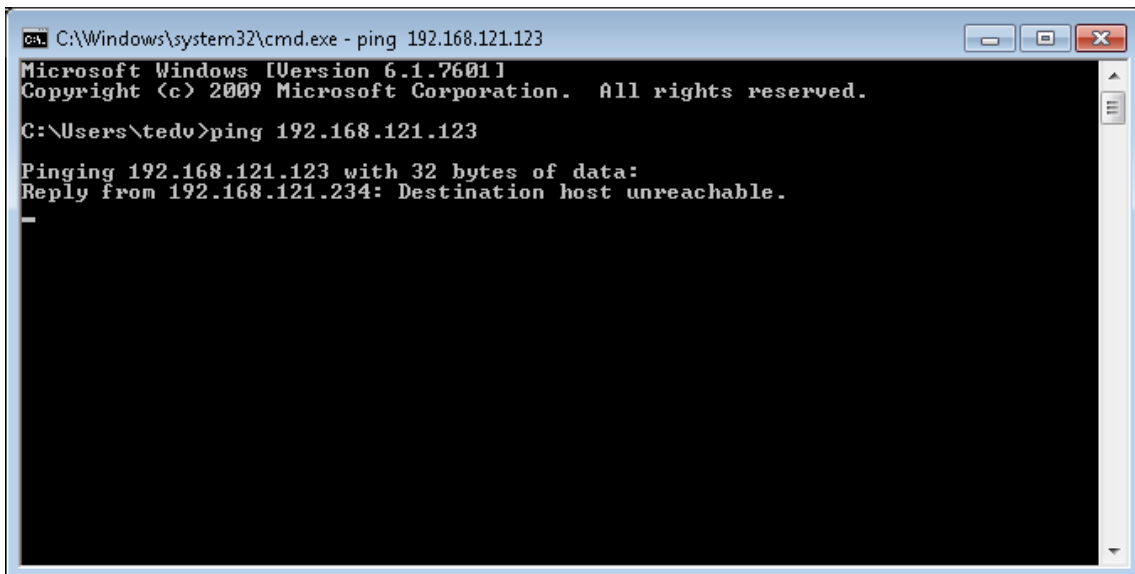

```
ca: C:\Windows\system32\cmd.exe - ping 192.168.121.123
Microsoft Windows [Version 6.1.7601]
Copyright (c) 2009 Microsoft Corporation. All rights reserved.

C:\Users\tedu>ping 192.168.121.123

Pinging 192.168.121.123 with 32 bytes of data:
Reply from 192.168.121.234: Destination host unreachable.
-

C:\Users\tedu>_
```

Fig. 5-3: Connection not OK

► Examine the communication path

Read the »Scanning« configuration file

The directory is: ..\simpati\system

- ▶ → ▶ »Open cmd.exe file:« (page 233)
- ▶ Entries:

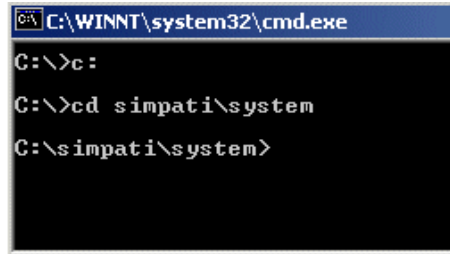

```
C:\WINNT\system32\cmd.exe
C:\>c:
C:\>cd simpati\system
C:\simpati\system>
```

Fig. 5-4: Entry

- ▶ Entry: simc2k /SCAN_TCPIP#192.168.121.36#7777#1#51

Response:

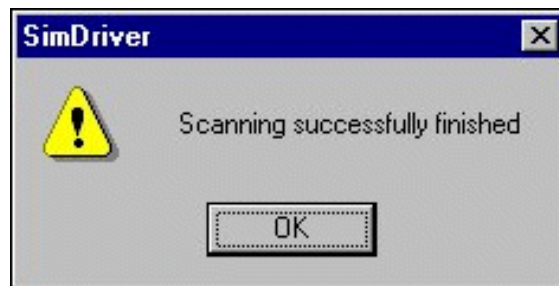

Fig. 5-5: Scanning OK

This function reads the chambers with the IP address 192.168.121.36 connected via the LAN, port 7777 as chamber number 1 with the logical address 51.

To save the configuration:

→ 3.1 »System configuration and registration« (page 30).

Response:

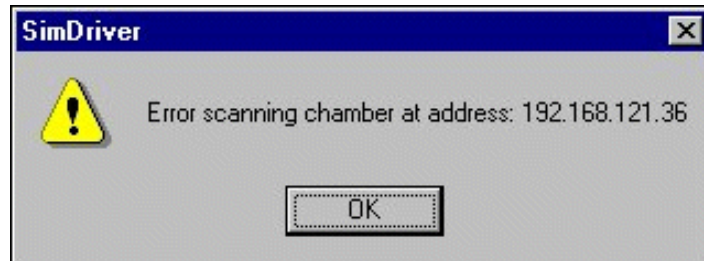

Fig. 5-6: Scanning failed

► Check the protocol selection and port on the control unit and adjust them if necessary.

→ »Check the network connection« (page 233)

Chamber 2

Repeat these steps for the second chamber with the address 192.168.121.37

A: 6 CHECK THE ADDRESS LIST

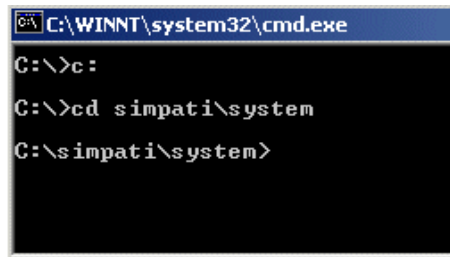

```
C:\WINNT\system32\cmd.exe
C:\>c:
C:\>cd simpati\system
C:\simpati\system>
```

Fig. 6-1: Entry

► Input: type simpati.adr

Output:

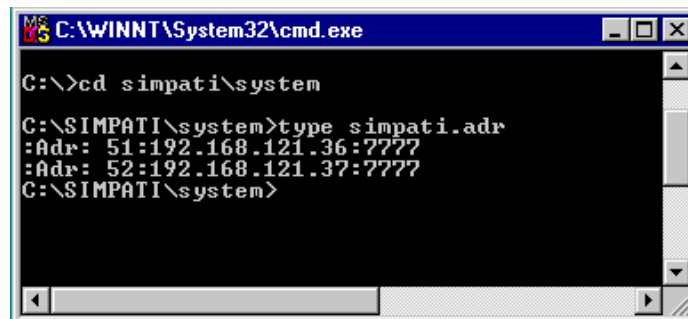

```
C:\WINNT\system32\cmd.exe
C:\>cd simpati\system
C:\SIMPATI\system>type simpati.adr
:Adr: 51:192.168.121.36:7777
:Adr: 52:192.168.121.37:7777
C:\SIMPATI\system>
```

Fig. 6-2: Output OK

Output:

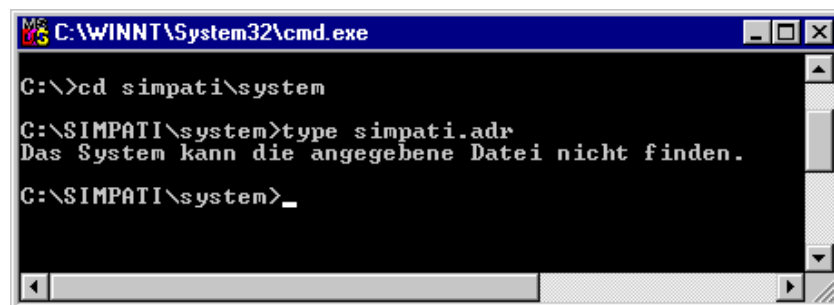

```
C:\WINNT\System32\cmd.exe
C:\>cd simpati\system
C:\SIMPATI\system>type simpati.adr
Das System kann die angegebene Datei nicht finden.
C:\SIMPATI\system>_
```

Fig. 6-3: Output faulty

Error: SIMPATI®.adr file was created.

Repeat steps:

- »Check the network connection« (page 233) and
- »Read the »Scanning« configuration file« (page 235)

► Launch SIMPATI®.

APPENDIX: OPERATION OF TS130 MODEL SHOCK CHAMBERS WITH SIMCON/32 CONTROLLER

A: 1 GENERAL

When running SIMPATI® to create programs, verify that control value #3 "Max. AmbTemp.Time" is set to at least 15 minutes as the nominal value.

If the control value is not programmed (nominal value = 0) this leads to error message "A031: Wait function time exceeded" immediately after the program starts.

In order that the control value is always initialised to at least 15 minutes, the steps below must be performed once during installation (or later as well).

A: 2 EXITING SIMPATI®

- ▶ Exiting the SIMPATI® software package.

A: 3 EDITING THE CONFIGURATION FILE

- ▶ Open the configuration file (simpati.cxx) of the relevant system using a text editor (e.g. Notepad) and change the MIN value of control value 3 from 0.0 to 15.0.

The files can be found in the directory c:\simpati\init.

```
/** analog output ** short/long/unit/Min-Max/ID *****/
```

```
:ST:001:Speed:Valve.Speed :% : 30.0: 100.0:1:
```

```
:ST:002:DEF:Defrist : : 0.0:1000.0:2:
```

```
:ST:003:MAT :Max.AmbTemp.Time :Min : 15.0: 100.0:3:
```

- ▶ Close and save the file.

A: 4 DELETING SHARED MEMORY

- ▶ Delete the hidden sim_cxx files in directory c:\simpati\system.
(xx = system number).

A: 5 STARTING SIMPATI®

- ▶ Starting the SIMPATI® software package.

A: 6 INITIALISING LIMIT VALUE

- Display SIMPATI® main screen, right-click on the appropriate system and select the “Limits” menu.

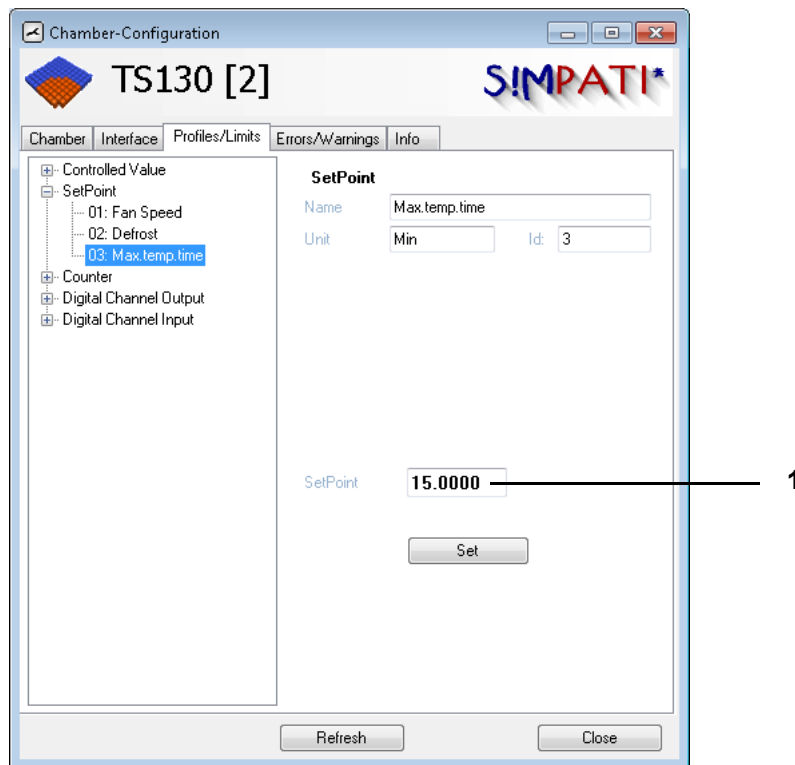

Fig. 6-1: Setting control value

- Set the nominal value (1) of the control value to "15.0".

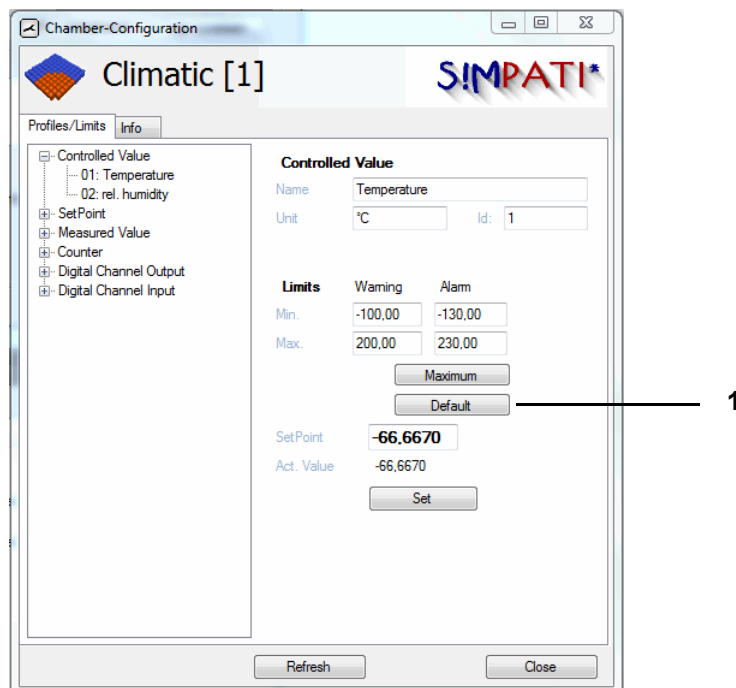

Fig. 6-2: Setting control variable

- Click on "Default" (1) for a control variable and then on "Set".

APPENDIX: INSTALLATION FOR OPERATION IN PHARMACEUTICAL ENVIRONMENTS



The installation of SIMPATI® in the pharmaceutical sector is only possible with version SIMPATI@2016, from patch 2.1.

This application complies with 21. CFR (Code of Federal Regulations), Part 11.

A: 1 OBJECTIVE

Install the SIMPATI® software package on the PC of the computer administrator to ensure that SIMPATI® administrator rights are needed for installation, configuration and start-up.

Users work on the PC with restricted standard user rights only. The SIMPATI® installation (installed files and folders) will therefore remain invisible to the user such that the user cannot manipulate or delete files or processes.

A: 2 SIMPATI® USER ADMINISTRATION AND ACTIVATING THE PHARMA VERSION

- Your initial SIMPATI® login password is »admin«. After entering it, you will be prompted to change the password. The new password must be at least 8 characters long (the minimum length can be configured between 8 and 30 characters, but 8 is selected by default). Make sure to use a complex password containing characters from at least three of the categories below:
 - Uppercase letters (A, B, C ... Z)
 - Lowercase letters (a, b, c ... z)
 - Numerals (1, 2, 3 ... 9)
 - Special characters, symbols, punctuation marks ({ } [] , . < > ; : , " ? / \ | ` % ^ & * () _ - + =)
- Password and user name must not be identical.
- The password can neither be entered via the clipboard (copy and paste) nor via keyboard or mouse events.
- Passwords expire after 60 days (however this can be increased to between 1 and 100 days by the administrator) and must be renewed. You will be automatically prompted to do this when you log on. Once passwords have been used, they are no longer valid and are stored in an encrypted file which cannot be viewed.
- Individual user passwords cannot be viewed by the administrator, including ones which have expired.
- The administrator can block and enable individual users.
- Only one user at a time can be logged in.
- The number of unsuccessful login attempts after which an individual user is blocked is set to 3 attempts by default (this can be configured to between 1 and 3 attempts).
- The administrator assigns, and can change at any time, rights to individual users specific to the system and chamber.
- Individual users can be managed and grouped in various user groups (administrators, users and guests). Users may also be defined without belonging to a group.
- The user is automatically logged out if there is no activity in the system for a set time (between 40 and 300 seconds). They must log in again before they can continue to use the system.

A: 3 SYSTEM PREREQUISITES

- Windows operating system Microsoft 2008, 2012.
- Windows operating system Microsoft 7, 8, 8.1l.
- Uninterruptible PC power supply.

A: 4 USER LOGOUT

If SIMPATI® is started with Simstart.exe as a collection of applications via the shortcut on the desktop, all SIMPATI® applications including communication and archiving are stopped when the user logs out.

Otherwise, the SIMPATI® core processes can be started as Windows services (by the SIMPATI® administrator) which continue to run when a user logs out.

APPENDIX: EXAMPLES

A: 1 EXAMPLE PROGRAM FOR A THERMAL AND CLIMATIC TEST CHAMBER WITH A SIMCON CONTROLLER

This example contains step-by-step explanation of how to create thermal and climatic program using the smbdl editor.

General descriptions of the basic editor functions can be found in chapter → 8.2 (page 94).

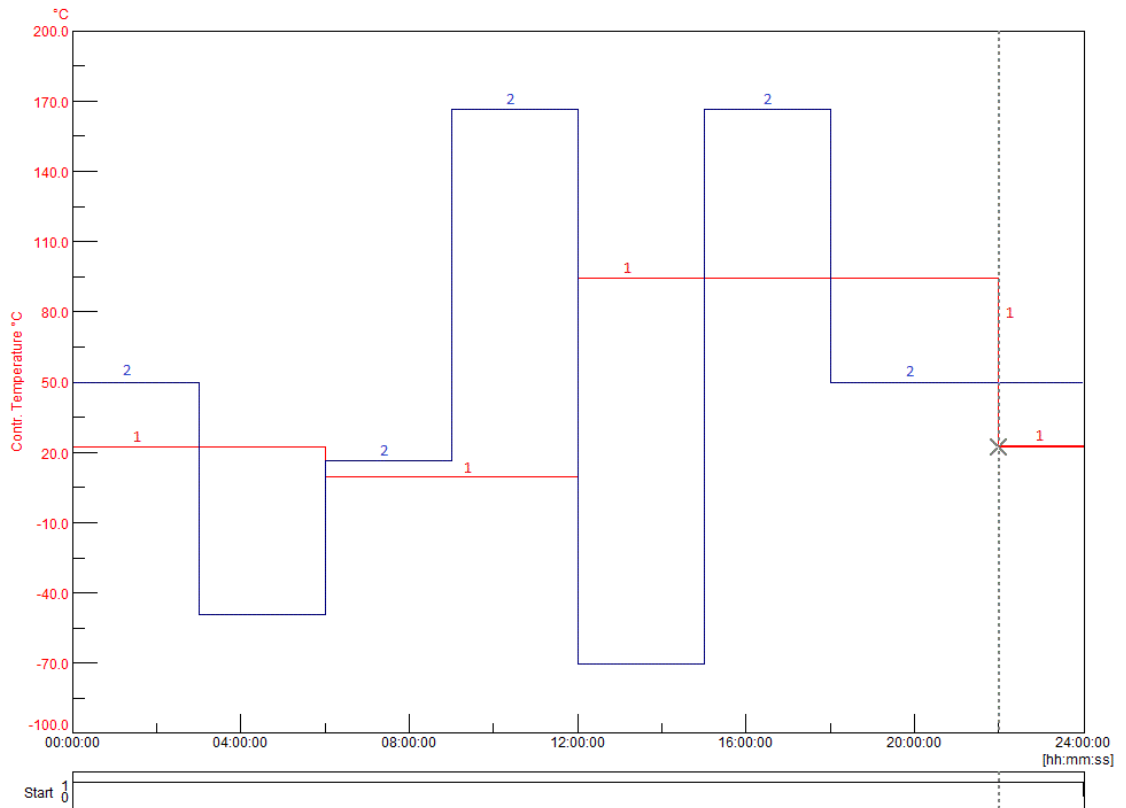







Fig. 1-1: Program preview

- 1 Control variable, rel. humidity % RH
- 2 Control variable, temperature °C









Programming digital channel »start«







Program block/input → Program block explanation		Explanation
	Start value: 1	Setting this digital channel starts the chamber.
	24 hours constant	The previously set status of the digital channel is retained for 24 hours.
	Insert this program block in the symbol chain to deactivate the digital channel.	

Programming digital channel »humidity«









Program block/input → Program block explanation		Explanation
	Start value: 1	Setting this digital channel turns on humidity control.
	24 hours constant	The previously set status of the digital channel is retained for 24 hours.
	Insert this program block in the symbol chain to deactivate the digital channel; the humidity is no longer controlled.	

Programming control variable »humidity«

Program block/input → Program block explanation		Explanation
	Start value: 50% → (page 246)	Sets relative humidity to 50 %.
	3 hours constant → (page 100)	For this time, the previously set nominal value will be retained.
	17% → (page 100)	There will be a jump down to 17 % RH, reducing the humidity level as quickly as possible.
	3 hours constant	For this time, the previously set nominal value will be retained.
	39%	There will be a jump up to 39 % RH, increasing the humidity level as quickly as possible.
	3 hours constant	For this time, the previously set nominal value will be retained.
	89%	There will be a jump up to 89 % RH, increasing the humidity level as quickly as possible.
	3 hours constant	For this time, the previously set nominal value will be retained.

Program block/input → Program block explanation		Explanation
	10%	There will be a jump down to 10 % RH, reducing the humidity level as quickly as possible.
	3 hours constant	For this time, the previously set nominal value will be retained.
	89%	There will be a jump up to 89 % RH, increasing the humidity level as quickly as possible.
	3 hours constant	For this time, the previously set nominal value will be retained.
	50%	There will be a jump down to 50 % RH, reducing the humidity level as quickly as possible.
	6 hours constant	The previously set nominal value (50% RH) is retained until the end of the program.

Programming control variable »temperature«

Program block/input → Program block explanation		Explanation
	Start value: 23 °C → 8.2.3 (page 97)	Sets the temperature to +23 °C
	6 hours constant → (page 100)	For this time, the previously set nominal value will be retained.
	Jumps down to 10 °C → (page 100)	The temperature changes to +10 °C, aiming to reach the nominal value as quickly as possible.
	6 hours constant	For this time, the previously set nominal value will be retained.
	Jumps up to 95 °C → (page 100)	Increases the temperature to +95 °C, aiming to reach the nominal value as quickly as possible.
	10 hours constant	For this time, the previously set nominal value will be retained.
	Jumps down to 23 °C → (page 100)	The temperature changes to +23 °C, aiming to reach the nominal value as quickly as possible.
	2 hours constant	For this time, the previously set nominal value will be retained.

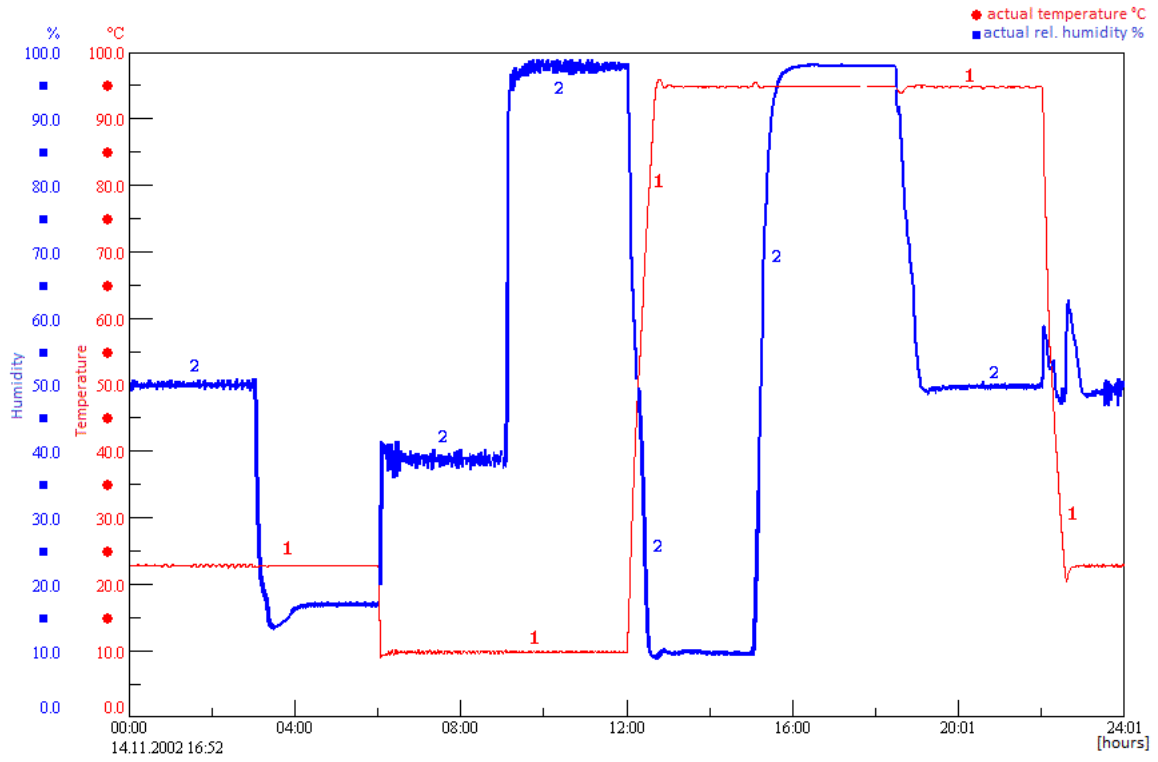

Fig. 1-2: Program sequence

A: 2 EXAMPLE PROGRAM FOR A HUMID SALT SPRAY CHAMBER WITH A SIMCON CONTROLLER

The following example explains an alternating climate test in accordance with VDA 621-415.

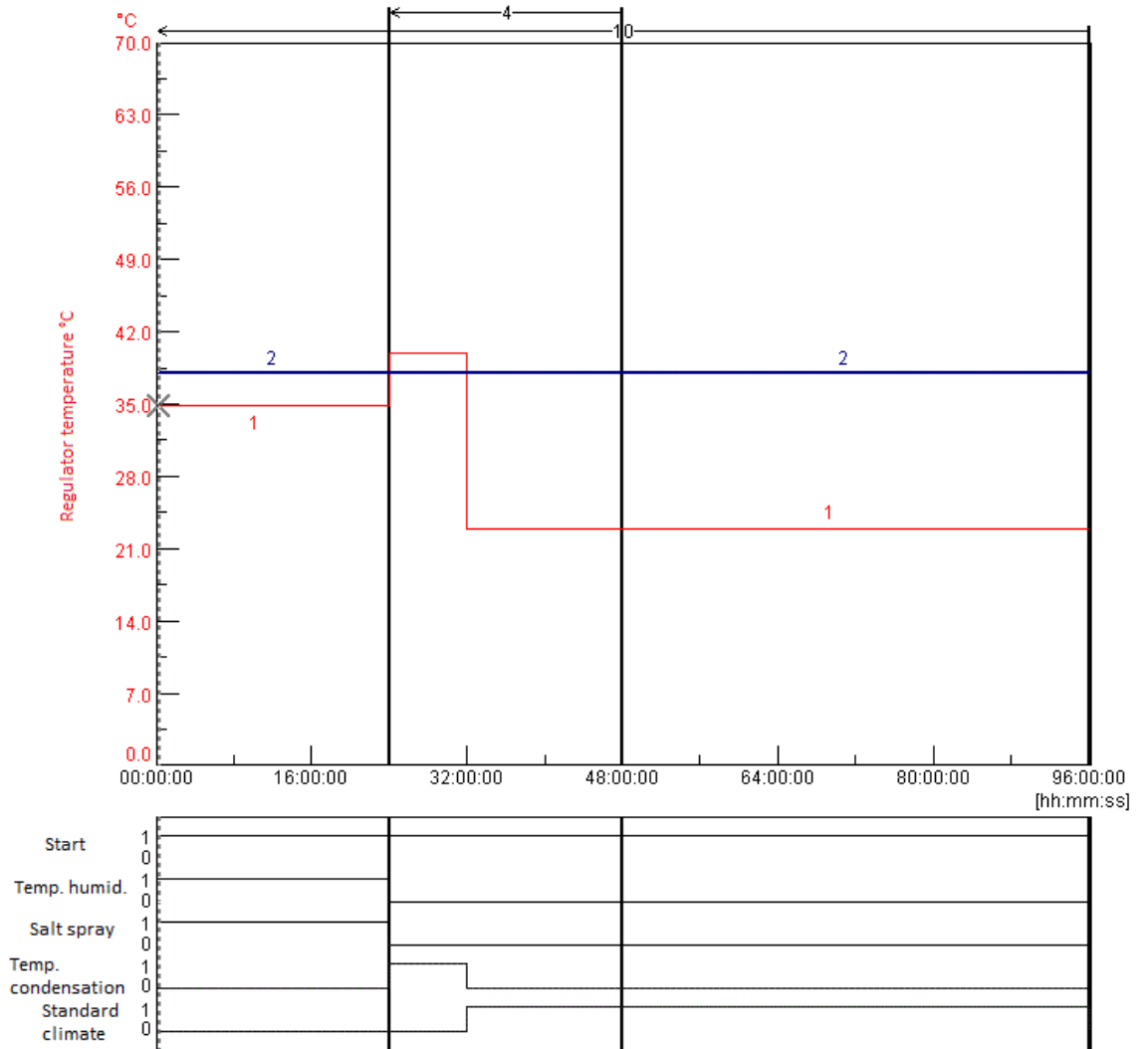











Fig. 2-1: Program preview





Programming digital channel »start«

Program block/input → Program block explanation		Explanation
	Start value: 1 → (page 100)	Setting this digital channel turns on the chamber.
	24 hours constant → (page 100)	The previously set status of the digital channel is retained for 24 hours.
	24 hours constant	The previously set status of the digital channel is retained for 24 hours; since the first block »constant« is not taken into account while jumping to the start of the loop, include this block repeatedly throughout the loop.
	48 hours constant	The previously set status of the digital channel is retained for 48 hours.







Programming digital channel »humidifier temp.«

Program block/input → Program block explanation		Explanation
	Start value: 1 → (page 100)	Setting this digital channel enables the nominal humidifier temperature.
	24 hours constant → (page 100)	The previously set status of the digital channel is retained for 24 hours.
	Insert this program block in the symbol chain to deactivate the digital channel.	
	24 hours constant	The digital channel has no effect on the test sequence for the next 24 hours.
	48 hours constant	The digital channel remains disabled for another 48 hours.







Programming digital channel »salt spray«

Program block/input → Program block explanation		Explanation
	Start value: 1 → (page 100)	Setting this digital channel starts the salt spray test.
	24 hours constant → (page 100)	The previously set status of the digital channel is retained for 24 hours.
	Insert this program block in the symbol chain to deactivate the digital channel.	
	24 hours constant	The digital channel has no effect on the test sequence for the next 24 hours.
	48 hours constant	The digital channel remains disabled for another 48 hours.







Programming digital channel »condensation water«

Program block/input → Program block explanation		Explanation
	0 → (page 100)	Setting this digital channel starts the condensation water test.
	24 hours constant → (page 100)	The digital channel has no effect on the test sequence for the next 24 hours.
	Insert this program block in the symbol chain to reactivate the digital channel.	
	8 hours constant	The digital channel is enabled for 8 hours.
	Insert this program block in the symbol chain to deactivate the digital channel.	
	16 hours constant	The digital channel has no effect on the test sequence for the next 16 hours.
	48 hours constant	The digital channel remains disabled for another 48 hours.









Programming digital channel »normal climate«

Program block/input → Program block explanation		Explanation
	0	Setting this digital channel starts the normal climate test
	24 hours constant	The digital channel has no effect on the test sequence for the next 24 hours.
	8 hours constant	The digital channel is enabled for 8 hours.
	Insert this program block in the symbol chain to reactivate the digital channel.	
	16 hours constant	The digital channel is enabled for 16 hours.
	48 hours constant	The digital channel remains enabled for another 48 hours.
	Insert this program block in the symbol chain to deactivate the digital channel.	

Programming control variable »temperature control«

Program block/input → Program block explanation		Explanation
	Start value: 35 °C → (page 100)	Sets the temperature to +35 °C
	24 hours constant → (page 100)	For this time, the previously set nominal value will be retained.
	Jumps up to 40 °C → (page 100)	Increases the temperature to +40 °C, aiming to reach the nominal value as quickly as possible.
	8 hours constant	For this time, the previously set nominal value will be retained.
	Jumps down to 23 °C → (page 100)	The temperature changes to +23 °C, aiming to reach the nominal value as quickly as possible.
	16 hours constant	For this time, the previously set nominal value will be retained.
	48 hours constant	For this time, the previously set nominal value will be retained.

Programming control variable »humidifier control«

Program block/input → Program block explanation		Explanation
	Start value: 49 °C → (page 100)	Sets the nominal humidifier temperature to 49 °C.
	Repeat 10	Start of loop - at the end of the loop, all program steps after this starting point will repeat 10 times Set an "end of loop" program block to be able to enter the number of repeats! The loop is automatically transferred to every profile.
	24 hours constant	For this time, the previously set nominal value will be retained.
	Repeat 4	Start of loop - all program steps after this start of the second loop will repeat 4 times Set an "end of loop" program block to be able to enter the number of repeats! The loop is automatically transferred to every profile.
	24 hours constant	For this time, the previously set nominal value will be retained.
	Repeat 4	End of loop - from here, the routine will return 4 times to the start of the loop until the main body of the test program is resumed.
	48 hours constant	For this time, the previously set nominal value will be retained.
	Repeat 10	End of loop - from here, the routine will return 10 times to the start of the loop until the entire test program is repeated.

A: 3 EXAMPLE PROGRAM FOR A SHOCK CHAMBER WITH A DMR CONTROLLER

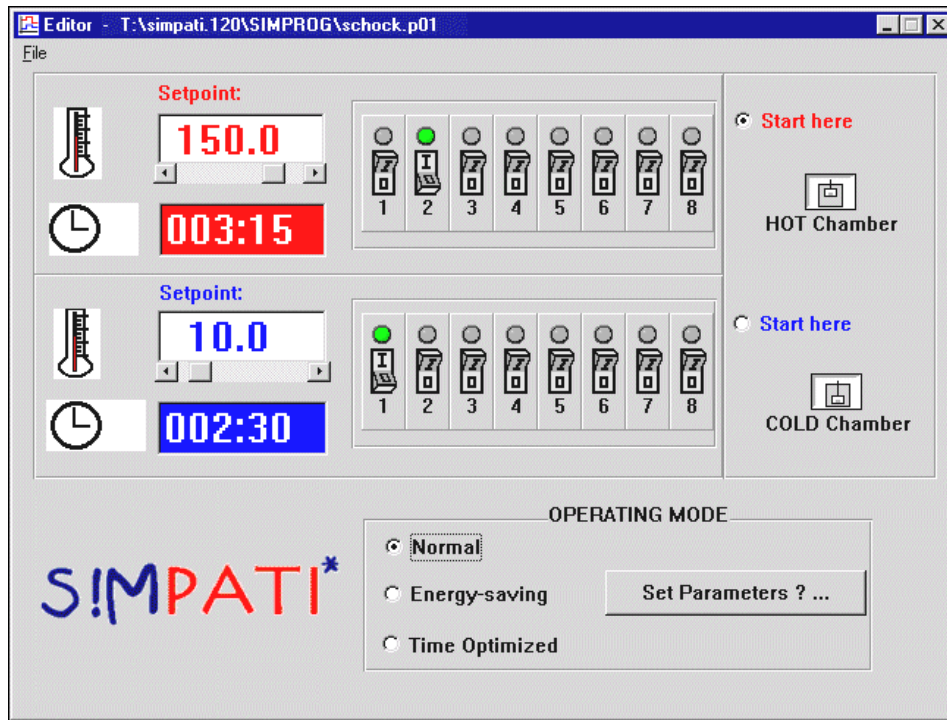

Fig. 3-1: Example: Shock chamber editor with DMR controller

In the example above, the lifting basket is to stay in the hot chamber for 3 hours and 15 minutes and in the cold chamber for 2 hours and 30 minutes. The test program starts in the hot chamber and is to run in normal mode.

Note that customer output #2 is set in the hot chamber and customer output #1 in the cold chamber.

A: 4 TEST PROGRAM EXAMPLE WITH PROGRAM ADVANCE

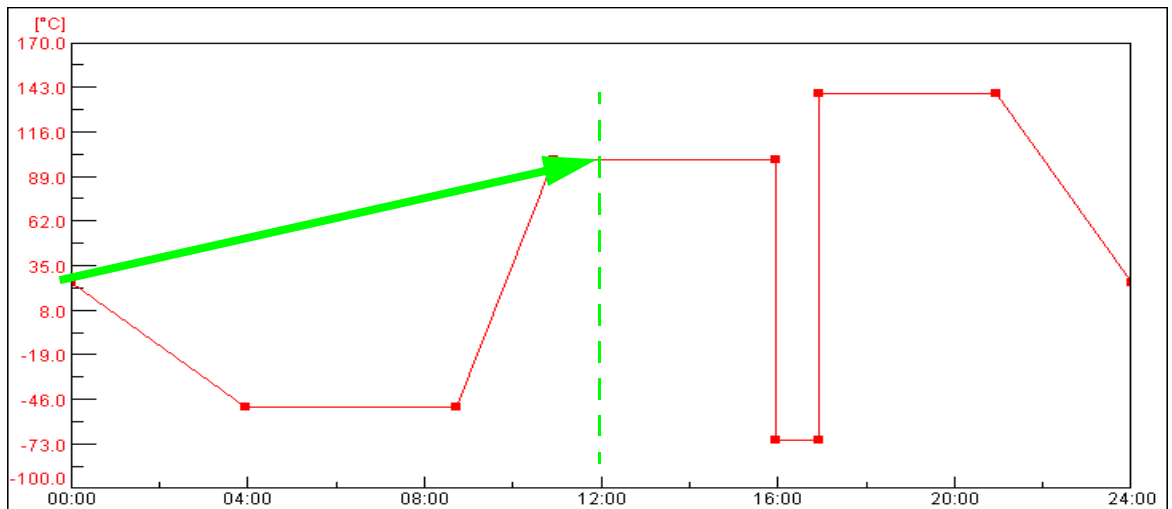

Fig. 4-1: Example »Program advance«

Start time: 12:00 o'clock

The function → 10 »Starting / stopping a test program« (page 153) is active; after startup the test program immediately goes to the status that would be reached after 12 hours according to the test program.

A: 5 SHOCK CHAMBER EDITOR PROGRAM EXAMPLE FOR A SHOCK CHAMBER WITH CTC CONTROLLER

Control variable				
		Nominal value	Lower alarm limit	Upper alarm limit
TempHot	°C	120.0	-90.0	230.0
TempCold	°C	-40.0	-90.0	230.0
TempeHot	°C	130.0	0.0	240.0
TemperCold	°C	-50.0	-90.0	80.0
TempLiftB	°C	0.0	-100.0	250.0
Pt100Move	°C	0.0	-100.0	250.0

Before the loop		
Time [min]	1	A 1-minute interval is completed before the start of the loops (cycles).
Start	ON	System status = ON
TempHot	ON	Tempering of hot chamber enabled.
TempCold	ON	Tempering of cold chamber enabled.

Before the loop		
LiftB.Up	ON	Lifting basket in hot chamber at first.
LiftB.Dn	OFF	Lifting basket not in cold chamber.
Defrosting	OFF	Cold chamber not to defrost.
Pretemper	ON	When the chamber is not in use, set its temperature to pretempering temperature.
Start Interr	OFF	Test program not to start in cold chamber.
WaitEnabled	OFF	This digital channel has no function. If the test program is to be run with the wait function, this function has to be added in the graphic editor later. → » <i>General profile settings</i> « (page 120)
CO2/LN2	OFF	CO2 or LN2 cooling is disabled.
Contr/ LiftBask	OFF	Control from the lifting basket disabled.
LampTest	OFF	Lamp test if off.
CustOFF1	OFF	Customer output 1 is off.
CustOFF2	OFF	Customer output 2 is off.

Cycles		
Cycles	100	In total, 100 cycles (i.e. 100 times sections 1-3 or 1-2) are executed.

After the loop		
Time [min]	30	A 30-min interval is completed after the loops (cycles).
Start	ON	System status = ON
TempHot	OFF	Tempering of hot chamber disabled.
TempCold	OFF	Tempering of cold chamber disabled.
LiftB.Up	ON	Lifting basket in hot chamber at the end.
LiftB.Dn	OFF	Lifting basket not in cold chamber.
Defrosting	ON	Cold chamber defrosts.
Pretemper	OFF	When not in use, the chamber is not pretempered.
Start Interr	OFF	Test program not to start in cold chamber.

WaitEnabled	OFF	This digital channel has no function. If the test program is to be run with the wait function, this function has to be added in the graphic editor later. → »General profile settings« (page 120)
CO2/LN2	OFF	CO2 or LN2 cooling is disabled.
Contr/ LiftBask	OFF	Control from the lifting basket disabled.
LampTest	OFF	Lamp test if off.
CustOFF1	OFF	Customer output 1 is off.
CustOFF2	OFF	Customer output 2 is off.

1st section		
Time [min]	60	60 min dwell time in hot chamber.
Start	ON	System status = ON
TempHot	ON	Tempering of hot chamber enabled.
TempCold	ON	Tempering of cold chamber enabled.
LiftB.Up	ON	Lifting basket in hot chamber.
LiftB.Dn	OFF	Lifting basket not in cold chamber.
Defrosting	OFF	Cold chamber not to defrost.
Pretemper	ON	When the chamber is not in use, set its temperature to pretempering temperature.
Start Interr	OFF	Test program not to start in cold chamber.
WaitEnabled	OFF	This digital channel has no function. If the test program is to be run with the wait function, this function has to be added in the graphic editor later. → »General profile settings« (page 120)
CO2/LN2	OFF	CO2 or LN2 cooling is disabled.
Contr/ LiftBask	OFF	Control from the lifting basket disabled.
LampTest	OFF	Lamp test if off.
CustOFF1	OFF	Customer output 1 is off.
CustOFF2	OFF	Customer output 2 is off.

2nd section		
Time [min]	60	60 min dwell time in hot chamber.
Start	ON	System status = ON
TempHot	ON	Tempering of hot chamber enabled.
TempCold	ON	Tempering of cold chamber enabled.
LiftB.Up	OFF	Lifting basket not in hot chamber.
LiftB.Dn	ON	Lifting basket in cold chamber.
Defrosting	OFF	Cold chamber not to defrost.
Pretemper	ON	When the chamber is not in use, set its temperature to pretempering temperature.
Start Interr	OFF	Test program not to start in cold chamber.
WaitEnabled	OFF	This digital channel has no function. If the test program is to be run with the wait function, this function has to be added in the graphic editor later. → »General profile settings« (page 120)
CO2/LN2	OFF	CO2 or LN2 cooling is disabled.
Contr/ LiftBask	OFF	Control from the lifting basket disabled.
LampTest	OFF	Lamp test if off.
CustOFF1	OFF	Customer output 1 is off.
CustOFF2	OFF	Customer output 2 is off.
3rd section		
Time [min]	0	This section is skipped as it involves a program example for a double shock chamber that no program is entered for.

Shock test program representation in the graphic editor:

Wait function added to TempHot and TempCold nominal value profile in the graphic editor.

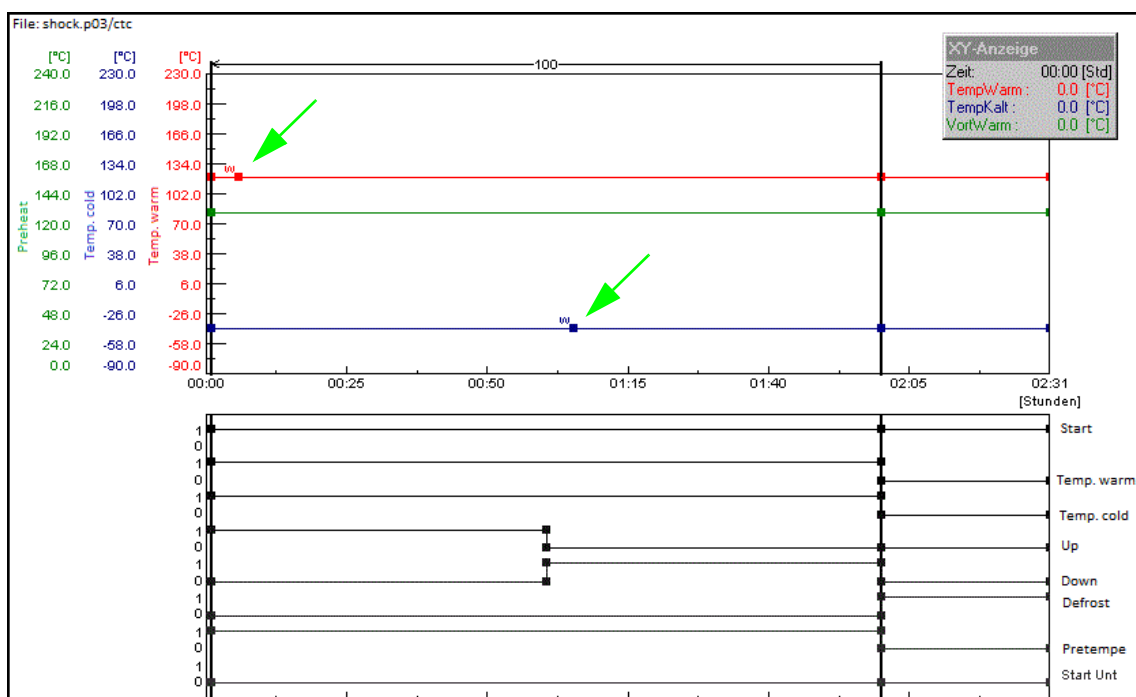

Fig. 5-1: Graphic shock test program representation

Adding the wait function ensures that the set cycle time will not start until the temperature of the lifting basket is within the adjustable wait tolerance limits (e.g. +/-5 K - factory-set default).

Set the data point »Hot Temp« or »Cold Temp« approx. 1 minute after moving the lifting basket and then activate the Wait function.

APPENDIX: GLOSSARY AND TIPS

Archive name

The name of the measured data log is referred to as archive name. If an archive name is not assigned, SIMPATI® automatically uses the date of the start of recording (year, month, day).

Automatic / program mode

The test sequence is based on a test program.

EPROM version

After the start, the EPROM version no. briefly lights up at the E4 terminal.

At the C terminal, press the »SYSTEM PARAM.« softkey in the start menu.

Flash version

Go to the »Touchpanel« and check the second line of the »CHAMBER INFORMATION« menu screen for the flash version no.

It can be reached from the main menu via the following icons.



Manual mode (hand mode)

Selection of nominal and control values as well as the switching on and off of digital channels, without the test sequence being based on a test program.

Background program → Foreground program

Control variables

Analog channel. Contains a measured (actual) value and a control (nominal) value. Normally, the temperature is the first control variable and humidity the second.

Context menu

To display the context menu, right-click once on the object concerned.



Depending on the chamber controller, different context menu commands are available.

Measured value

Actual value, analog input.

Test program name / Program number

Every test program has its own test program name used for saving by SIMPATI®. The test program is given a number when it is downloaded. The test program is loaded into the chamber controller and saved under this test program number.

Use only letters, numbers and the underline key for the test program name.

The chamber controller provides test program slots 0 to 99 (DMR controller: 1-100). In chambers with CTC / TC / MOPS controllers, test program slots 100 to 120 are assigned standard programs (→ chamber operating manual).

* = any number of characters, **xx** = chamber number.

- Type *.cfg

Names of test programs written for shock chambers with a DMR controller in the text editor are extended by *.cfg and saved as type *.pxx.

- Type *.pxx

Test programs created using the graphic editor

→ 8.3 »Using the graphic editor to create test programs« (page 112) are saved as type *.pxx.

- *cp.pxx

If a test program is copied from another chamber and the file name is not manually changed by the user, »cp« is added to the original file name and the number of the destination chamber is changed.

- Type *.bxx

- Programs created in the symbol editor → 8.2 »Using the symbol editor to create test programs« (page 94) or in the shock chamber editor → 8.5 »Creating test programs for a shock test chamber« (page 138) are saved as type *.bxx.

- Type *.rpt

Report files are saved as type *.rpt. The report files store daily reports.

File names set by SIMPATI® are made up of the date in the following format:
year/month/day.

- Type *.rptb

Encrypted report file.

- type *.hxx / *.rxx

A measurement file consists of a header file (*.hxx) and a body file (*.rxx).

The header file contains data on the configuration and structure of the measurement file.

The body file contains the measured values. When a measurement file is loaded, the header file is loaded and the measured values in the corresponding body file are accessed at the same time.

If the body file cannot be accessed, the loading process is interrupted with a message. In all processes, the program will automatically execute both the header file and the body file.

- Type *.dxx

The test program can be displayed step by step, printed and saved in a written format as a program list (*.dxx). You cannot manipulate the test program at this point, though.

Control value

Analog output.

Foreground / background program

A background program may run at the same time as another test program. Several foreground programs run successively. A total of at most 3 test programs can run simultaneously.

These settings only affect the test sequence if the wait function and the → *Call program* function are being used.

Take heed of the instructions for the different types of controllers in chapter → 3.9 »*Other controllers, third-party devices and their special features*« (page 40).

Counter

Displays the counter readings.

Passionately innovative.

We work in partnership to support companies in research, development, production and quality assurance. With 22 companies in 15 countries at 40 locations.

weisstechnik

Test it. Heat it. Cool it.



Environmental Simulation

The first choice for engineers and researchers for innovative, safe environmental simulation facilities. In fast motion, our test systems can simulate all the influences in the world as well as for instance in space. In temperature, climate, corrosion, dust or combined stress tests. With a very high degree of reproducibility and precision.



Climate Technology, Air Dehumidification, Clean Rooms

As the leading provider of clean rooms, climate technology and air dehumidification, we consistently ensure optimal climatic conditions for people and machines. For industrial production processes, in hospitals, mobile operation tents or in the field of information and telecommunications technology. From project planning to implementation.



Heat Technology

Experienced engineers and designers develop, plan and produce high-quality, reliable heat technology systems for a broad range of applications from heating and drying cabinets to microwave systems and industrial furnaces.



Clean Air and Containment Systems

With decades of experience and know-how, we guarantee the most sophisticated clean air and containment solutions. Our comprehensive and innovative range of products includes barrier systems, laminar flow systems, safety workbenches, isolators and airlocks.

Weiss Umwelttechnik GmbH

Greizer Straße 41-49
35447 Reiskirchen/Germany
T +49 6408 84-0
info@weiss-technik.com

Vötsch Industrietechnik GmbH

Beethovenstraße 34
72336 Balingen/Germany
T +49 7433 303-0
info.voetsch@weiss-technik.com

www.weiss-technik.com

