

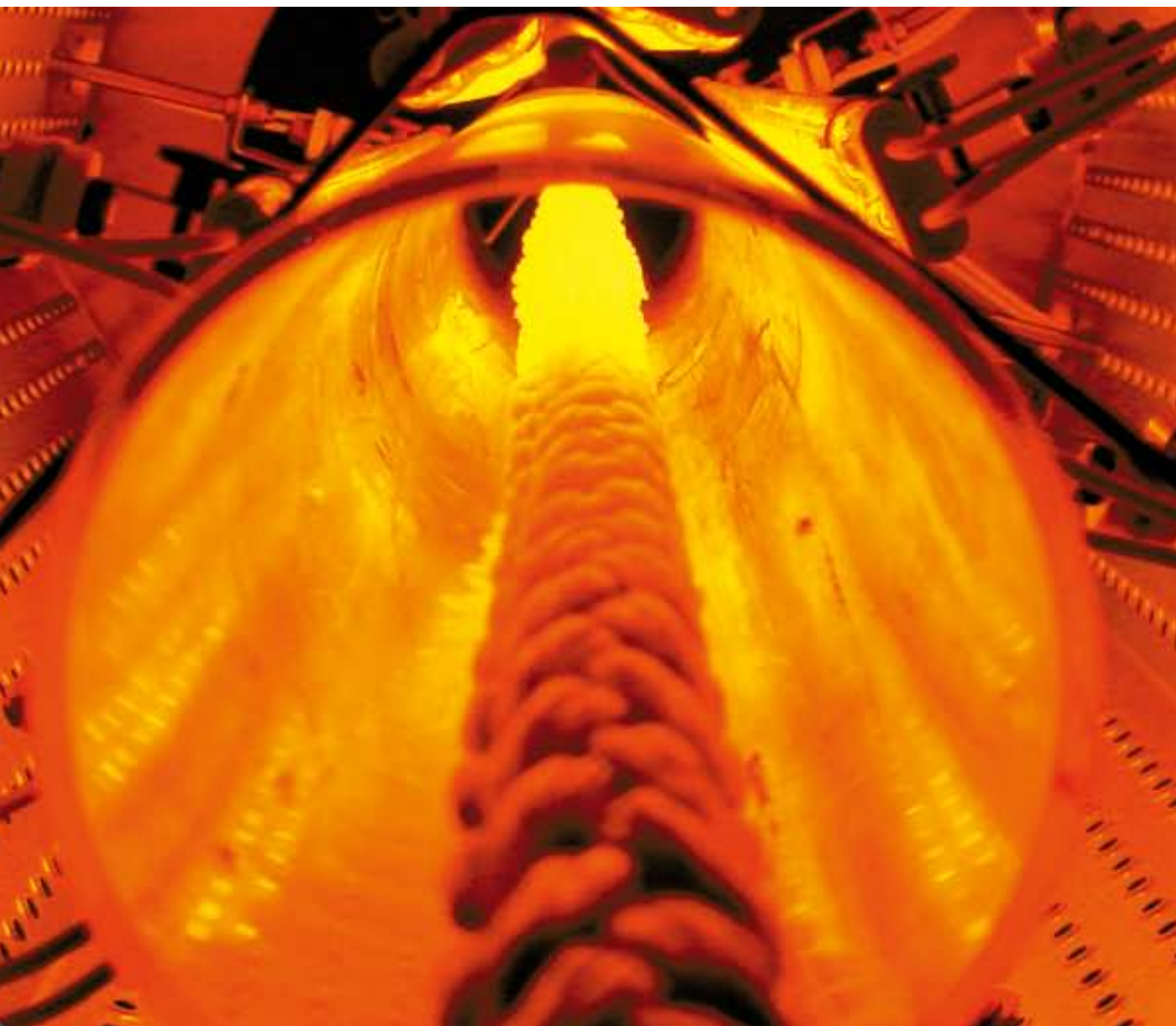

Infrared Emitters for Industrial Processes

Heraeus Noblelight

A Powerful Partner



Contents

Heraeus Noblelight understands the need of manufacturers to make industrial heating processes more efficient. A Heraeus heater is always matched to the process – and not vice versa. Experience with thousands of heat processes, own application centers and competent and responsive people are the foundation to make heat processes faster, more energy-efficient, space-saving and quality-orientated.

Heraeus Noblelight – Decades of experience

The origins of Heraeus Noblelight are to be found in the Heraeus Organization in the year 1899, when high purity quartz glass was melted from mountain crystal for the first time. Shortly afterwards, the world's first industrial quartz lamp was developed, which paved the way for today's light source technology.

With a background of many decades of experience, Heraeus now develops, manufactures and markets a wide range of infrared and ultraviolet emitters and components, which find application in all important sectors and areas of industry.

Modern production processes need intelligent heat

Infrared thermal technology is efficient and precise. Today there is scarcely a product which doesn't come into contact at least once with infrared radiation during its manufacture – and this is a growing trend. Consequently, it is even more important that the correct emitter is selected for every application.

Heraeus Noblelight covers the total spectrum of technically usable wavelengths and can help find the optimum light source to suit specific processes.

Perfectly matched infrared emitters allow heating processes to be carried out at great efficiency with the right amount of energy. Reliable and reproducible manufacturing processes save costs.



All about infrared 4



The Golden 8 infrared emitter 6



Round tube infrared emitters 10



Special emitters 12

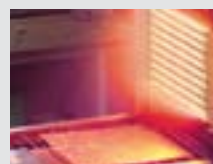

Applications 14

More information

Still got questions? Our CD "Infrared heating solutions" and our brochures contains lot of information about infrared technology and Heraeus emitters. Obtain your copy of the CD and the brochures simply by e-mailing: hng-infrared@heraeus.com

Infrared

Intelligent Heat – precise and efficient

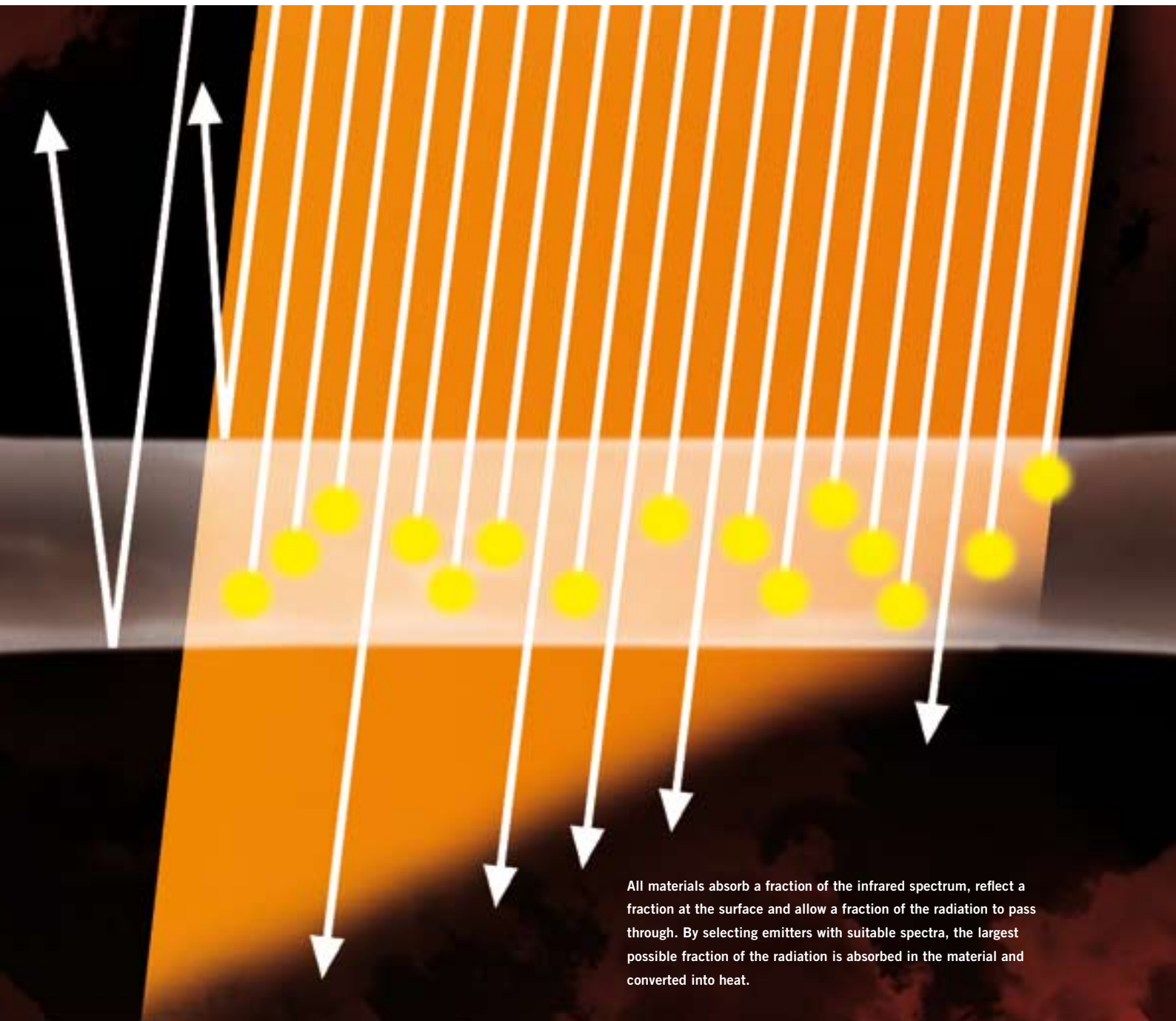

Quartz glass infrared emitters frequently prove superior to conventional heating sources such as warm air, steam, ceramic, gas or metal emitters, because they transfer large amounts of energy very quickly and can be precisely matched to the product and the manufacturing step – the ideal heating process.

- Infrared radiation requires neither contact nor intermediate transfer medium
- Quartz glass infrared emitters are precisely matched to the materials to be heated
- Fast response times allow controllable heat
- Heat is applied precisely where and only for so long as it is required

Compared for example to warm air heating, this often means less energy consumption, higher line speed, a smaller footprint and better heating results.

To achieve successful process heating, it is important that the infrared emitter is carefully matched to the properties of the product to be heated in terms of its wavelength, its shape and its power output. Radiation which precisely matches the absorption characteristics of the product is quickly converted into heat in the product, without unnecessary heat being transferred to the surroundings. It also saves time and money if products can be transferred quickly for further processing after the heating stage.

The correct wavelength

Depending on the temperature of the heating element, an infrared emitter delivers distinctly different radiation at various wavelengths.

It is important to select the correct emitter for the product, as the wavelength has a significant influence on the heating process. Short wave radiation can penetrate deep into some solid materials and ensure a uniform through heating. Medium wave radiation is absorbed mostly in the outer surface and predominantly heats the surface. Medium wave radiation is particularly well absorbed by many plastics, glass and especially water and is converted directly into heat.

Proportion of heat

	< 2µm	2–4µm	> 4µm	Typical emitter
600 °C	2,2%	37,2%	60,6%	Ceramic/Metal Sheathed
900 °C	13,0%	46,4%	40,6%	Standard Medium Wave
1200 °C	26,1%	46,9%	27,0%	Carbon
1600 °C	43,2%	40,1%	16,7%	Fast Response Medium Wave
2200 °C	62,5%	28,7%	8,8%	Short Wave
2700 °C	73,3%	21,0%	5,7%	Halogen/NIR
3000 °C	77,9%	17,6%	4,5%	High Powered Halogen/NIR

Correct selection of heaters

If the temperature of the heating element of a short wave emitter is greatly reduced, medium wave infrared radiation can be emitted. However, the emitter power output then drops so much that economical heating is no longer possible. Consequently, for applications in the medium wave range, only medium wave emitters should be used, as these offer five times the power output at the same temperature.

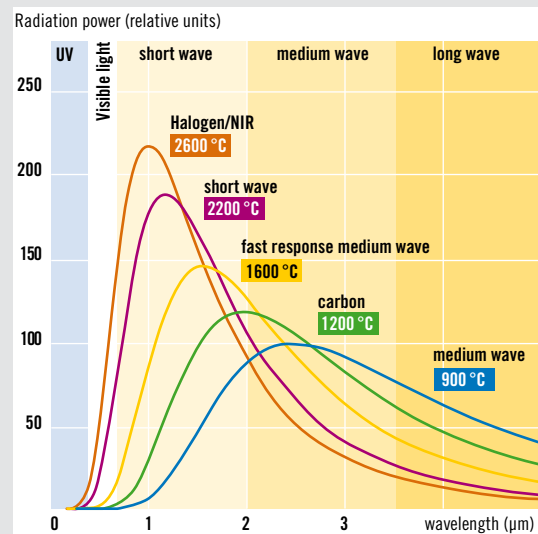

Spectral radiation curves for different infrared emitters, normalised to the same power.

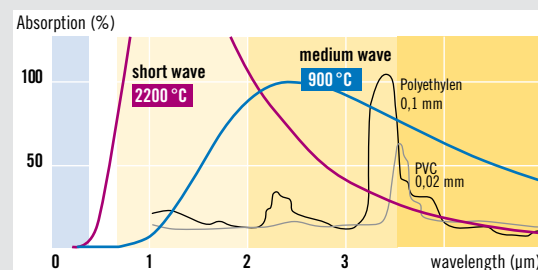

Plastics such as polyethylene and polyvinylchloride are particularly good absorbers of infrared radiation in the medium wave region.

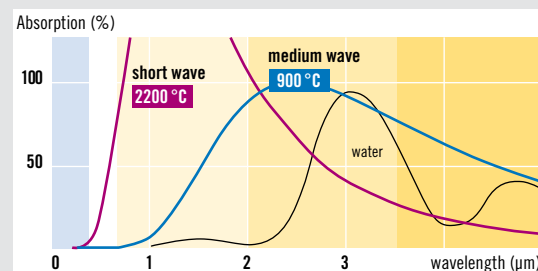

Water evaporates more quickly with medium wave infrared emitters as water absorbs radiation particularly well in this region.

Golden 8

Packaged Heat at the ready

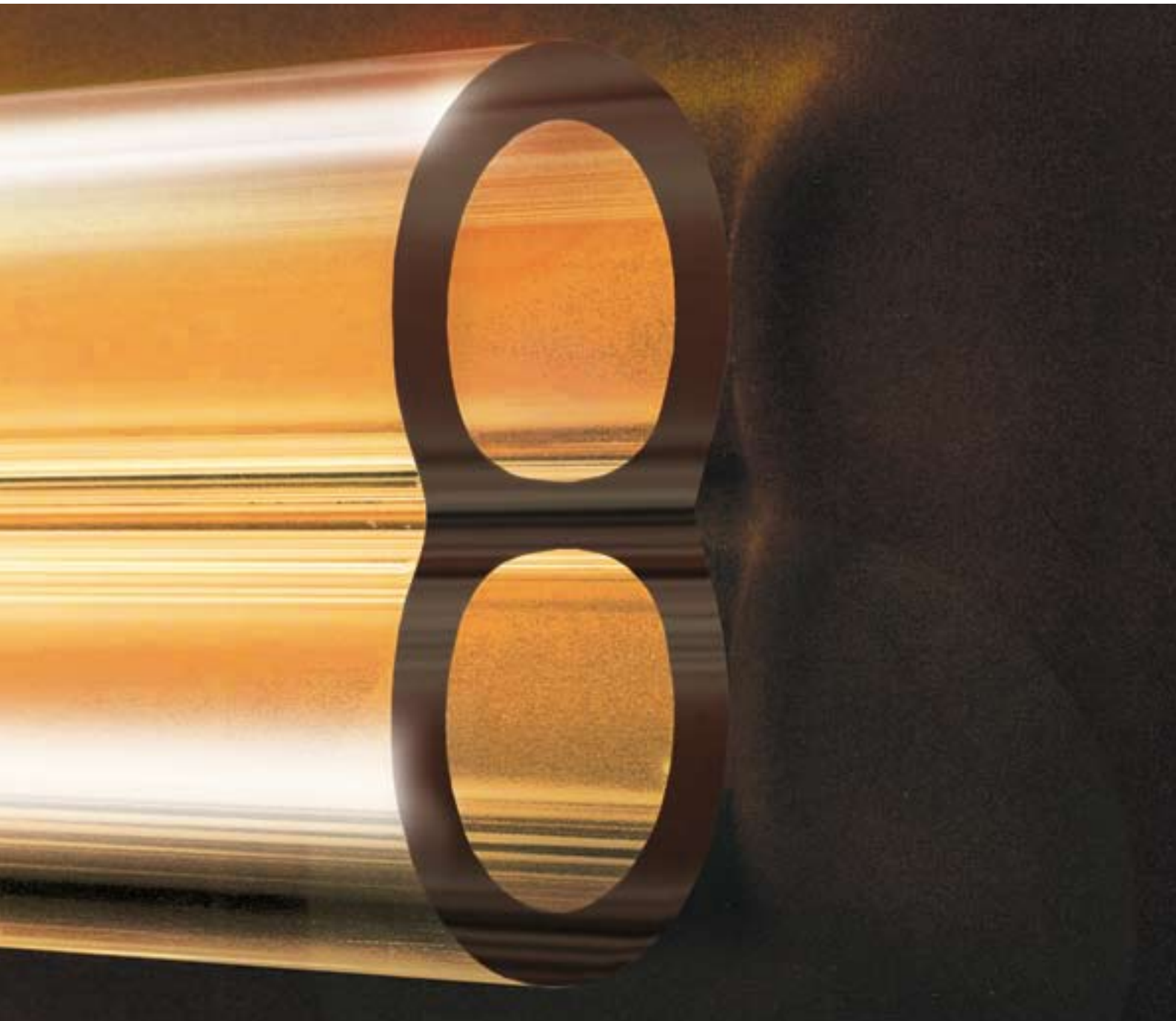



Golden 8

A reliable sign of competence and quality in infrared heating: the Golden 8 is the basis of all our twin tube emitters and is the starting point for new solutions in heating processes.

Quartz Glass

Heraeus Golden 8 infrared emitters are manufactured from high quality quartz tubes. Quartz glass is very pure and provides good transmission and temperature resistance.

Twin Tube

The unique twin tube design offers high radiation power and very good mechanical stability – allowing emitters of lengths up to 6.5 metres. Wave lengths, dimensions and filaments are matched to requirements.

Gold Reflector

Heraeus Noblelight offers infrared emitters which by virtue of a gold reflector can emit heat directly to the product. A gold coating on the infrared emitters reflects the infrared radiation. Consequently the infrared radiation impinging on the product is virtually doubled.

QRC® nano reflector

The new level is QRC® (quartz reflective coating). This new nano reflector consists of opaque quartz glass which sits directly on the emitter. Quartz glass is extremely heat-resistant, as well as being resistant to attacks from acids, alkalis and other aggressive substances. Heating processes can be carried out significantly better in vacuum or at high surrounding temperatures.

Best materials and technologies

Heraeus Noblelight has inhouse access to advanced quartz glass and gold technology in the Heraeus group. This ensures consistently high quality and performance of all Heraeus emitters and makes new developments for special needs possible.

Design of the twin tube emitter

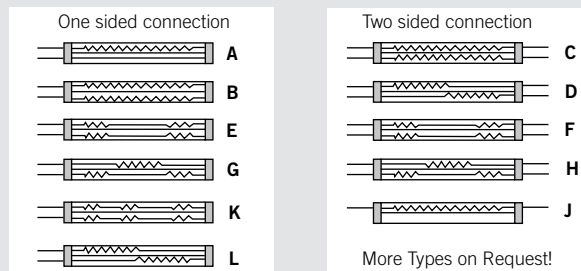

Emitter characteristics



— Robust ceramic socket

— Top quality quartz glass for good transmission and temperature resistance

— Gold reflector for directed radiation and high efficiency

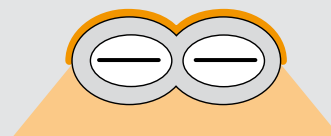

— Heating filament, available in designs to suit different wavelengths

— Twin tube (the Golden 8) for high stability and twice the power, available in different lengths

Infrared emitters fixing innovative technical textiles



Carbon twin emitters flow and cure powder coatings efficiently



Carbon Infrared Emitters CIR®

Heraeus Carbon infrared emitters feature a unique heating filament design so that medium wave radiation offering very fast reaction times is possible. All Carbon infrared emitters CIR® offer high surface power densities and speed up heating processes at high efficiency.

Comprehensive tests have shown that Carbon emitters dry water-based coatings significantly more efficiently than short wave infrared emitters. A Carbon infrared emitter may require only up to 30% of the energy for the same drying process as a conventional short wave infrared emitter. Moreover, many materials such as glass and plastics show a decided preference for thermal radiation in the medium wave region.

Carbon emitters combine medium wave radiation at high Watts density with response times in terms of seconds.

Short wave twin tube emitters are similar to halogen emitters in terms of spectrum but offer significant benefits in terms of lifetime, strength and durability.

Fast response medium wave emitters are twin tube emitters with a spectrum between those of short wave and medium wave emitters. These emitters are offered at lengths of up to 6.5m.

Medium wave emitters distinguish themselves with their high cost-efficiency, stability and operating life. The spectrum is suitable for heating processes in most materials.





Infrared emitters need a flexible but firm holder so that they can operate correctly



Accessories Needed For Installation

Every infrared emitter requires a clamping spring and a holding spring to ensure that the emitter is held elastically. Long emitters should be supported in the middle and medium wave emitters have a longer operating life when they are supported by a right angled safety bracket. These springs and other accessories can be found on the internet at: www.heraeus-noblelight.com/infrared on the Products/Accessories pages. We are pleased to consult you by phone, +49 (6181) 35-8545.

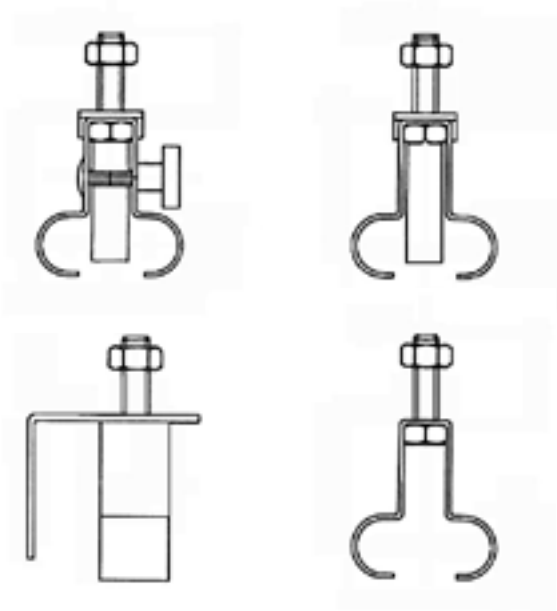

Technical data

Twin tube emitter	Short wave	Fast response medium wave	Medium wave	Carbon
Max. specific power W/cm	< 200	80	18/20/25*	80
Max. heated length mm	6400/2400*	6400/2400*	1500/2000/6500*	3000
Cross-section mm	34 x 14	34 x 14	18 x 8	34 x 14
	23 x 11	23 x 11	22 x 10	
			33 x 15	
Filament temperature °C	1800–2400	1400–1800	800– 950	1200
Peak wavelength µm	1.0–1.4	> 1.4	2.4–2.7	2
Max. surface power density kW/m ²	200	150	60	150
Response time s	1	1–2	60-90	1–2

* Depending on cross-section

Golden 8 standard emitters

	Power [Watts]	Voltage [Volts]	Heated length [mm]	Total length [mm]	Emitter type	Item number
Medium wave	500	230	300	400	B	09752439
	1000	230	500	600	B	09755167
	2000	230	800	900	B	09755054
	2500	230	1000	1100	B	09755255
	3250	230	1300	1420	B	09753187
	3750	230	1500	1600	B	09754585
	4100	400	1700	1800	B	09754863
	4500	400	1800	1920	B	09754783
	5750	400	2300	2400	B	09756083
	6250	400	2500	2600	B	09753874
Short wave	2500	230	1200	1300	C	09753923
	3000	400	1000	1100	A	09751720
	600	115	80	145	B	09751713
	1500	230	200	300	B	09751751
	1200	230	340	405	B	09751741
	3000	400	500	600	B	09751740
	3000	400	500	600	B	09751340
	3000	230	500	650	C	09751761
	4200	230	700	850	C	09751765
	6000	400	1000	1150	C	09751760
Carbon	7000	400	1300	1450	C	09751731
	4600	230	600	745	B	45134868
	4000	230	700	845	B	80009221
	8000	400	1000	1145	B	45134870
	7800	400	1100	1245	B	80012442
	9000	230	1250	1400	C	80012443

Specials available on request!

Starting current

When switching on an emitter, it can reach peak current in a very short time. This needs to be considered when designing your system.

For further information please contact us!

Emitter type	Element temperature	Switch-on current factor
SW	1800-2400 °	12–17
FRMW	1400–1800 °	10–13
MW	800–950 °	1–1,05
Carbon	1200 °	0,8

Round Tube Emitters



For many applications, an infrared emitter consisting of just a heating element in a quartz tube is the perfect choice. Such emitters are, in the main, shorter than twin tubes. Obviously, round tube emitters can also be fitted with a gold reflector.

Halogen short wave (NIR) radiation

is provided by halogen infrared emitters with a spectrum in the near infrared region, a maximum power density of 1 MW per square metre and very fast response times. These emitters are manufactured in top quality quartz glass and are conventionally round tubes. An optional gold reflector can virtually double the amount of effective radiation drop out on the product.

Halogen Short Wave/NIR



Carbon round tube



Technical data

Carbon round tube IR emitter	
Max. specific power W/cm	40
Max. heated length mm	1500
Cross-section mm	19
Filament temperature °C	1200
Peak wavelength μm	2
Max. specific power kW/m ²	100
Response time s	1–2

Round tube standard emitters

	Power [Watts]	Voltage [Volts]	Heated length [mm]	Total length [mm]	Diameter [mm]	Item number
Carbon round tube emitter (without gold reflector)						
	1000	57,5	300	430	19	45132877
	2000	115	600	730	19	45132876
Carbon round tube emitter (with gold reflector)						
	1000	57,5	300	430	19	45132828
	2000	115	600	730	19	45132833
	4000	200	1000	1145	19	45134446
Short wave round tube (without gold reflector)						
	500	115	120	225	10	09751510
Short wave round tube (with gold reflector)						
	500	115	120	225	10	09751515

Clamp and holding springs

Every infrared emitter needs a clamping- and holding-spring to ensure that the emitter is held correctly. For further information please contact us!

	Tube format mm	Dimensions mm					Item number
		a	b	c	d	M	
Spring holder	10	10	10	20	25	4	09 759 292
	19	19	19	25	30	6	45 106 267
Clamp holder	10	10	10	20	25	4	09 759 293
	19	19	19	25	30	6	45 106 266

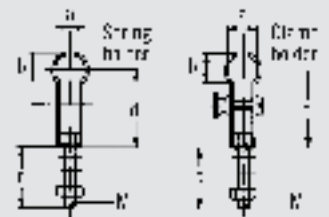

Special Emitters

Heat precisely where it's needed



Edges, corners and contours are followed exactly and heated in a focused manner



Infrared emitters need not always be long and straight. We are guided totally by the product and process



Heraeus infrared emitters are precisely matched to the relevant production process. They heat large surfaces as well as small edges. The potential for flexible design also allows emitters to be produced to match complex geometry work pieces and because infrared emitters can be switched on and off in seconds, they allow significant savings in both energy and operating costs. Plastic components are welded, riveted or de-burred efficiently within seconds because heat can be rapidly and precisely applied to the right place.

Energy losses to the environment are incredibly small and production process times can be reduced or more parts can be produced in the same time.

Contoured emitters

Individually shaped emitters can follow work piece corners and edges to allow any required bending process or for the local activation of adhesives.

Small surface emitters

Short wave emitters heat complex geometries so that two surfaces can be joined without adhesive.

Omega emitters

Circular short wave emitters for hot staking. With heat up and cooling times in terms of seconds, very short process times can be realised.

QRC® Emitter

Many sensitive heating processes run faster, more efficiently and more stable when infrared emitters with the QRC reflector are used. A reflector helps to target infrared radiation. The QRC (quartz reflective coating) reflector consists of high purity quartz material, which is a coating on the tube.

As a result, the emitter is very compact and requires very little working space. The nano reflector has very good heat resistance and is also resistant to acids, alkalis and other aggressive substances. Consequently, emitters with this reflector can be used even in manufacturing processes where the manufacturing plant requires regular cleaning with corrosive cleaning agents.

Heating processes can be carried out significantly better in vacuum, for example for the production of solar cells.

New are QRC heaters which are bent or formed to fit exactly to edges or contours of a product. This helps to target heat e.g. for deburring or welding of three dimensional plastics products.

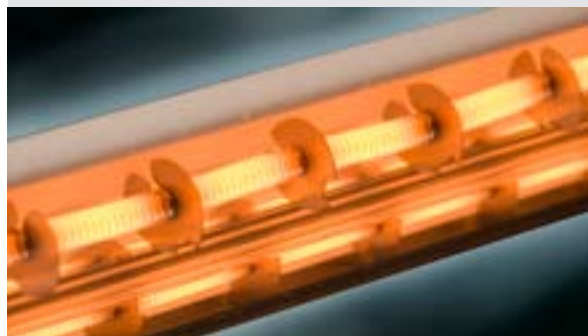

Application Center

Practically-based Support

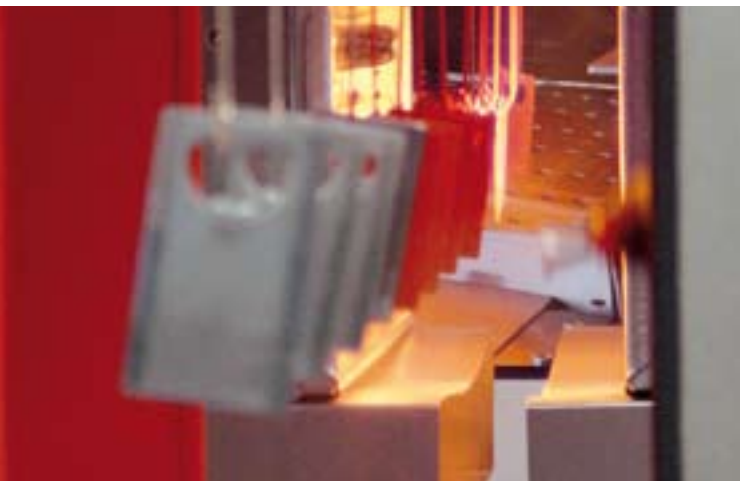

There is scarcely a product manufactured which does not pass at least once through a heating process during its manufacture. Coatings are dried, adhesives activated and plastics heated before forming.

More efficient heating processes are achieved by better energy utilization. As a result, heating is shorter, in terms of time or in terms of space requirement, so that the complete production plant is more cost-efficient.

You have to understand the different applications to exploit infrared heating productively. Heraeus Noblelight has set up Applications Centers to increase its knowledge through investigations and tests and to share experiences with customers. With its Application Centers, Heraeus offers all its customers the opportunity to answer important questions, from a practical rather than a merely theoretical viewpoint:

- Can my process be optimized with infrared?
- Is my material suitable for infrared?
- Which emitters are best suited to my process?
- How should these emitters be designed?
- How can they be integrated into my production process?

Application examples:

Modern textiles need modern heat

High quality technical textiles must be perfectly fixed and coatings on webs must be dried as quickly as possible. Demands are ever increasing and heating processes must keep pace. Infrared transfers heat precisely where it is needed, quickly and at high power.

Better processing of foodstuffs with Carbon emitters

Carbon infrared emitters can be used to brown the breadcrumb topping or other garnishing on ready meals, without cooking the meal through. Carbon emitters prove more efficient than conventional heating sources, saving energy and valuable production space, as well as minimizing maintenance costs.

More efficient car manufacture

Increasing competition forces finishing and coating departments in the automotive industry to reduce energy costs and shorten manufacturing times. Infrared modules can be fitted before existing drying ovens to bring the product quickly to the correct temperature before the existing drying oven holds the product at this temperature for as long as necessary. This arrangement helps to maintain production throughput and, frequently, increase it.





The Industrial Process Technology division of Heraeus Noblelight (business segment specialty lighting sources) develops and manufactures infrared emitters and systems for industrial heating processes. For over 50 years we have focused on their specific application requirements. With a wealth of experience encompassing more than 3000 different heating processes, we can match our emitters precisely to meet your needs in terms of spectrum, power, length and shape.

Make use of the intelligence of infrared technology. In contrast to conventional thermal processes, infrared transmits large amounts of energy in a short time. This heat is used exactly where it is required and only for as long as it is required for a particular process. This offers energy savings of up to 50%.

Profit from the acknowledged Heraeus quality – the proven twin tube design with a unique length of up to 6.5 meters – contoured emitters, which are shaped to match the geometry of your work piece – the new QRC® emitter, with its nano reflector for stable heating processes under aggressive ambient conditions. Convince yourself personally of the efficiency of infra-red emitters for your process in our Application Centers.

Make use of our expertise and experience to optimize your production process and realize real competitive advantage.

Germany
Heraeus Noblelight GmbH
Reinhard-Heraeus-Ring 7
63801 Kleinostheim
Phone +49 (6181) 35-8545
Telefax +49 (6181) 35-168410
hng-infrared@heraeus.com
www.heraeus-noblelight.de/infrarot

Great Britain
Heraeus Noblelight Ltd.
Unit 1 Millennium Court
Clayhill Industrial Estate
Buildwas Road
Neston, Cheshire CH64 3UZ
Phone +44 (151) 353 2710
Telefax +44 (151) 353 2719
lan.bartley@heraeus.com
www.heraeus-noblelight.com/infrared

USA
Heraeus Noblelight LLC
2150 Northmont Parkway, Suite L
Duluth, GA 30096
Phone +1 (770) 418-0707
Telefax +1 (770) 418-0688
info@noblelight.net
www.noblelight.net

China
Heraeus (Shenyang) Noblelight Ltd.
Shanghai Branch
4F, 11th Building
No.99 Tianzhou Rd.
200233 Shanghai
Phone +86 (21) 5445 2255
Telefax +86 (21) 5445 2410
Info.hns@heraeus.com
www.heraeus-noblelight.cn



Reg. No. 39254